



ROUND STONES

Round Stones are loose crystal elements. Most of them are pointed on the reverse side, making them easy to apply in either metal claw settings or pre-set cavities.

The assortment features a wide variety of different cuts and sizes, the most innovative being the XIRIUS Chaton and the smallest being the XERO Chaton ~~in size PPO~~. The science of the cut and the celebration of crystal as high art came together in the XIRIUS Chaton, Swarovski's most brilliant crystal element ever.



Merging a gemstone-like cut with rich, varied color and Platinum[®] colored foiling for exceptional durability, XIRIUS takes crystal one step closer to the diamond.



Communication on Product-Assortment changes*

IMPORTANT INFORMATION ON ASSORTMENT ADJUSTMENTS

We would kindly like to inform you about overall portfolio streamlining as well as discontinuations of selected product lines, effective as of November 23rd, 2020.

In order to allow you sufficient time to prepare, upcoming changes are already visible in our B2B e-commerce platform. During this transition phase the collection has been marked with the following caption:

Caption - SUMMARY	
	OUT OF ASSORTMENT
	CHANGES IN THE ASSORTMENT
	NO CHANGES IN THE ASSORTMENT

Caption - MATRIX	
	OUT OF ASSORTMENT
	FUTURE MADE TO ORDER ITEM - MTO
	FUTURE MADE TO STOCK ITEM - MTS

SUMMARY

1 2 3 S



1100

PP 0, 1



COREASSORTMENT

1028

PP 2, 3, 4, 5, 6, 7, 8, 9, 10, 11, 12, 13



COREASSORTMENT

1088

PP 14, 15, 16, 17, 18, 19, 20, 21, 22, 23, 24, 25, 26, 27, 28, 29, 30, 31, 32
SS 18, 19, 20, 21, 22, 24, 26, 28, 29, 30, 34, 35, 38, 39, 40, 45, 48, 50, 55
25, 50 mm



COREASSORTMENT

1122

SS 17, 24, 29, 34, 39, 47
12, 14, 16, 18 mm



1128

PP 32
SS 29, 39



1185

1 mm
PP 9, 14, 22



1188

SS 17, 24, 29, 39



1201

27, 35 mm



1318

30, 55 mm



1357

20, 50, 80 mm



DESIGNER EDITION

1681

12, 16 mm



DESIGNER EDITION

1695

10, 14 mm



1400

10, 12, 14, 18 mm

1100 XERO Chaton

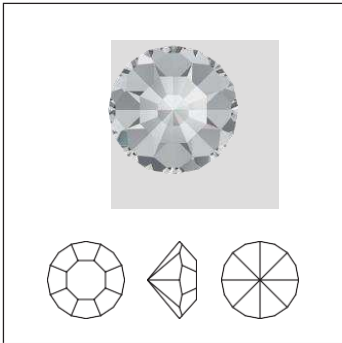

Siz
PP 0
PP 1

Crystal

Crystal F (001)

Colors

Plain Colors

Black Diamond F (215)

Jet F (280)

Light Amethyst F (212)

Light Colorado Topaz F (246)

Light Peach F (362)

Light Rose F (223)

Peridot F (214)

Sapphire F (206)

Crystal Effects

Transparent Effects

Crystal AB F (001 AB)

Crystal Golden Shadow F (001 GSHA)

Crystal Silver Shade F (001 SSHA)

Color Effects

Metallic Effects

Jet Hematite F (280 HEM)

CORE ASSORTMENT

1028 XILION Chaton

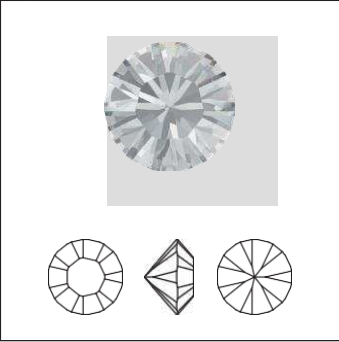

Size	PP 2	PP 3	PP 4	PP 5	PP 6	PP 7	PP 8	PP 9	PP 10	PP 11	PP 12	PP 13
------	------	------	------	------	------	------	------	------	-------	-------	-------	-------

Crystal

Crystal (001)								■	■	■		■
Crystal F (001)	■	■	■	■	■	■	■	■	■	■	■	■

Colors

Plain Colors

Amethyst F (204)	■	■	■	■	■	■	■	■	■	■	■	■
Aquamarine F (202)	■	■	■	■	■	■	■	■	■	■	■	■
Black Diamond F (215)	■	■	■	■	■	■	■	■	■	■	■	■
Blue Zircon F (229)		■	■	■				■	■	■		■
Blush Rose F (257)								■	■	■		■
Burgundy F (515)								■	■	■		■
Capri Blue F (243)								■	■	■		■
Chrysolite F (238)		■	■	■				■	■	■		■
Denim Blue F (266)								■	■	■		■
Emerald F (205)	■	■	■	■	■	■	■	■	■	■	■	■
Erinite F (360)		■	■	■				■	■	■		■
Fern Green F (291)								■	■	■		■
Fuchsia F (502)		■	■	■	■	■	■	■	■	■		■
Graphite F (253)		■	■					■	■	■		■
Greige F (284)		■	■	■				■	■	■		■
Indian Sapphire F (217)								■	■	■		■
Indian Siam F (327)		■	■	■				■	■	■		■
Indicolite F (379)		■	■	■				■	■	■		■
Iris F (219)		■	■	■	■			■	■	■		■
Jet (280)	■	■	■	■	■	■	■	■	■	■	■	■
Jet F (280)	■	■	■	■	■	■	■	■	■	■	■	■
Jonquil F (213)		■	■	■	■	■	■	■	■	■	■	■
Light Amethyst F (212)	■	■	■	■	■	■	■	■	■	■	■	■
Light Azore F (361)		■	■	■				■	■	■		■
Light Colorado Topaz F (246)	■	■	■	■	■	■	■	■	■	■	■	■
Light Peach F (362)	■	■	■	■	■			■	■	■		■
Light Rose F (223)	■	■	■	■	■	■	■	■	■	■	■	■
Light Sapphire F (211)		■	■	■	■	■	■	■	■	■	■	■
Light Siam F (227)	■	■	■	■	■	■	■	■	■	■	■	■
Light Silk F (261)								■	■	■		■

1028	Siz	PP 2	PP 3	PP 4	PP 5	PP 6	PP 7	PP 8	PP 9	PP 10	PP 11	PP 12	PP 13
Light Smoked Topaz F (221)			■	■	■	■			■	■	■		■
Light Topaz F (226)		■	■		■	■		■	■	■	■	■	■
Light Turquoise F (263)									■	■	■		■
Majestic Blue F (296)			■	■	■	■			■	■	■		■
Montana F (207)		■	■	■	■	■	■	■	■	■	■	■	■
Padparadscha F (542)			■	■	■				■	■	■		■
Peridot F (214)		■	■	■	■	■	■	■	■	■	■	■	■
Rose F (209)			■	■	■	■	■	■	■	■	■	■	■
Ruby F (501)									■	■	■		■
Sapphire F (206)		■	■	■	■	■	■	■	■	■	■	■	■
Scarlet F (276)		■	■	■	■	■	■	■	■	■	■	■	■
Siam F (208)		■	■	■	■	■	■	■	■	■	■	■	■
Silk F (391)		■	■	■	■	■	■	■	■	■	■	■	■
Smoked Topaz F (220)			■	■	■				■	■	■		■
Smoky Mauve F (265)									■	■	■		■
Smoky Quartz F (225)			■	■	■	■			■	■	■		■
Tangerine F (259)			■						■	■	■		■
Tanzanite F (539)		■	■	■	■	■	■	■	■	■	■	■	■
Topaz F (203)			■	■	■				■	■	■	■	■
Vintage Rose F (319)		■	■	■	■	■			■	■	■	■	■
Violet F (371)			■	■	■	■	■	■	■	■	■	■	■
Opal Colors													
Air Blue Opal F (285)									■	■	■		■
Light Grey Opal F (383)									■	■	■		■
Pacific Opal F (390)									■	■	■		■
Rose Water Opal F (395)											■		■
White Opal F (234)			■	■	■	■	■	■	■	■	■	■	■
Yellow Opal F (231)									■	■	■		■
Crystal Effects													
Transparent Effects													
Crystal Antique Pink F (001 ANTP)									■	■	■		■
Crystal AB F (001 AB)		■	■	■	■	■	■	■	■	■	■	■	■
Crystal Blue Shade F (001 BLSH)									■	■	■		■
Crystal Golden Shadow F (001 GSHA)		■	■	■	■	■	■	■	■	■	■	■	■
Crystal Luminous Green F (001 LUMG)									■	■	■		■

1028

	Siz												
	PP 2	PP 3	PP 4	PP 5	PP 6	PP 7	PP 8	PP 9	PP 10	PP 11	PP 12	PP 13	
Crystal Moonlight F (001 MOL)		■	■	■	■			■	■	■		■	
Crystal Paradise Shine F (001 PARSH)								■	■	■		■	
Crystal Silver Night F (001 SINI)	■	■	■	■	■	■	■	■	■	■	■	■	
Crystal Silver Shade F (001 SSHA)	■	■	■	■	■	■	■	■	■	■	■	■	
Metallic Effects													
Crystal Dorado F (001 DOR)		■	■	■				■	■	■		■	
Crystal Light Chrome F (001 LTCH)								■	■	■		■	
Crystal Metallic Blue F (001 METBL)								■	■	■		■	
Crystal Metallic Light Gold F (001 MLGLD)		■	■	■				■	■	■		■	
Crystal Metallic Sunshine F (001 METSH)		■						■	■	■		■	
Crystal Rose Gold F (001 ROGL)		■	■	■				■	■	■		■	
Color Effects													
Black Diamond Shimmer F (215 SHIM)							■	■	■	■		■	
Erinite Shimmer F (360 SHIM)								■	■	■		■	
Light Colorado Topaz Shimmer F (246 SHIM)							■	■	■	■		■	
Light Rose Shimmer F (223 SHIM)							■	■	■	■		■	
Light Sapphire Shimmer F (211 SHIM)							■	■	■	■		■	
Light Siam Shimmer F (227 SHIM)							■	■	■	■		■	
Light Topaz Shimmer F (226 SHIM)								■	■	■		■	
Jet Hematite (280 HEM)	■	■	■	■	■			■	■	■		■	
Jet Hematite F (280 HEM)					■			■		■			

CORE ASSORTMENT

1088 XIRIUS Chalon

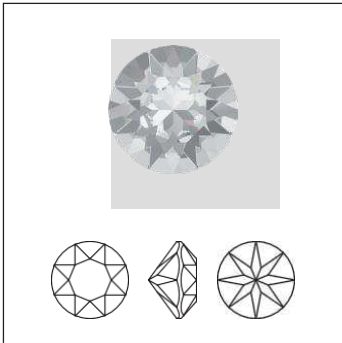

Siz	PP-14	PP-15	PP-16	PP-17	PP-18	PP-19	PP-20	PP-21	PP-22	PP-23	PP-24	PP-25	PP-26	PP-27	PP-28	PP-29	PP-30	PP-31	PP-32	SS-18
-----	-------	-------	-------	-------	-------	-------	-------	-------	-------	-------	-------	-------	-------	-------	-------	-------	-------	-------	-------	-------

Crystal

Crystal (001)																					
Crystal F (001)																					

Colors

Plain Colors

Amethyst F (204)																					
Aquamarine F (202)																					
Black Diamond F (215)																					
Blue Zircon F (229)																					
Blush Rose F (257)																					
Burgundy F (515)																					
Capri Blue F (243)																					
Chrysolite F (238)																					
Denim Blue F (266)																					
Emerald F (205)																					
Erinite F (360)																					
Fern Green F (291)																					
Fuchsia F (502)																					
Graphite F (253)																					
Greige F (284)																					
Indian Sapphire F (217)																					
Indicolite F (379)																					
Iris F (219)																					
Jet (280)																					
Jet F (280)																					
Jonquil F (213)																					
Light Amethyst F (212)																					
Light Azure F (361)																					
Light Colorado Topaz F (246)																					
Light Peach F (362)																					
Light Rose F (223)																					
Light Sapphire F (211)																					
Light Siam F (227)																					
Light Silk F (261)																					
Light Smoked Topaz F (221)																					



1088

	Siz	PP 14	PP 15	PP 16	PP 17	PP 18	PP 19	PP 20	PP 21	PP 22	PP 23	PP 24	PP 25	PP 26	PP 27	PP 28	PP 29	PP 30	PP 31	PP 32	SS 18
Light Topaz F (226)		■				■			■			■							■	■	
Light Turquoise F (263)		■				■			■			■							■	■	
Majestic Blue F (296)		■				■			■			■							■	■	
Montana F (207)		■				■			■			■			■				■	■	
Padparadscha F (542)		■				■			■			■							■	■	
Peridot F (214)		■				■			■			■			■				■	■	
Provence Lavender F (283)		■				■			■			■							■	■	
Rose F (209)		■	■	■	■	■			■			■			■				■	■	
Rose Peach F (262)		■				■			■			■							■	■	
Ruby F (501)		■				■			■			■							■	■	
Sapphire F (206)		■	■	■	■	■			■			■			■				■	■	
Scarlet F (276)		■	■	■	■	■	■	■	■	■	■	■	■	■	■	■	■	■	■	■	■
Siam F (208)		■				■			■			■			■				■	■	
Silk F (391)		■				■			■			■							■	■	
Smoked Topaz F (220)		■				■			■			■			■				■	■	
Smoky Mauve F (265)		■				■			■			■							■	■	
Smoky Quartz F (225)		■				■			■			■							■	■	
Tangerine F (259)		■				■			■			■							■	■	
Tanzanite F (539)		■				■			■			■			■				■	■	
Topaz F (203)		■				■			■			■			■				■	■	
Vintage Rose F (319)		■				■			■			■			■				■	■	
Violet F (371)		■				■			■			■							■	■	
Opal Colors																					
Air Blue Opal F (285)		■				■			■			■							■	■	
Light Grey Opal F (383)		■				■			■			■							■	■	
Pacific Opal F (390)		■				■			■			■							■	■	
Rose Water Opal F (395)		■				■			■			■							■	■	
White Opal F (234)		■				■			■			■			■				■	■	
Yellow Opal F (231)		■				■			■			■							■	■	
Crystal Effects																					
Transparent Effects																					
Crystal Antique Pink F (001 ANTP)		■				■			■			■							■	■	
Crystal AB F (001 AB)		■	■	■	■	■	■	■	■	■	■	■	■	■	■	■	■	■	■	■	■
Crystal Blue Shade F (001 BLSH)		■				■			■			■							■	■	
Crystal Golden Shadow F (001 GSHA)		■				■			■			■			■				■	■	

1088	Siz	PP 14	PP 15	PP 16	PP 17	PP 18	PP 19	PP 20	PP 21	PP 22	PP 23	PP 24	PP 25	PP 26	PP 27	PP 28	PP 29	PP 30	PP 31	PP 32	SS 18	
		Crystal Ignite (001 IGNIT)												◆								◆
Crystal Luminous Green F (001 LUMG)		■				■			■			■								■	■	
Crystal Moonlight F (001 MOL)		■				■			■			■								■	■	
Crystal Paradise Shine F (001 PARSH)		■				■			■			■								■	■	
Crystal Silver Night F (001 SINI)		◆				◆			◆			◆								◆	◆	
Crystal Silver Shade F (001 SSHA)		◆				◆			◆			◆			◆					◆	◆	
Metallic Effects																						
Crystal Dorado F (001 DOR)		■				■			■			■								■	■	
Crystal Light Chrome F (001 LTCH)		■				■			■			■								■	■	
Crystal Metallic Blue F (001 METBL)		■				■			■			■								■	■	
Crystal Metallic Light Gold F (001 MLGLD)		■				■			■			■								■	■	
Crystal Metallic Sunshine F (001 METSH)		■				■			■			■								■	■	
Crystal Rainbow Dark F (001 RABDK)		■				■			■			■								■	■	
Crystal Rose Gold F (001 ROGL)		■				■			■			■								■	■	
Crystal Scarabaeus Green F (001 SCGR)		■				■			■			■								■	■	
Crystal Patina																						
Crystal Black Patina F (001 BLAPA)												■								■	■	
Crystal Gold Patina F (001 GOLPA)												■								■	■	
Crystal Rose Patina F (001 ROSPA)												■								■	■	
Crystal Silver Patina F (001 SILPA)												■								■	■	
Crystal White Patina F (001 WHIPA)												■								■	■	
Crystal Lacquer <sup>Pro</sup>																						
Crystal Army Green DeLite (001 L130D)																						
Crystal Azure Blue (001 L112S)									■													
Crystal Burgundy DeLite (001 L132D)																						
Crystal Buttercup (001 L124S)																						
Crystal Cappuccino DeLite (001 L133D)																						
Crystal Dark Grey (001 L111S)									■													
Crystal Dark Red (001 L108S)																						
Crystal Ivory Cream (001 L106S)									■													
Crystal Laguna DeLite (001 L142D)																						
Crystal Lavender DeLite (001 L144D)																						
Crystal Light Coral (001 L116S)																						
Crystal Light Grey DeLite (001 L129D)																						
Crystal Lilac (001 L126S)																						

*** designed by Jean Paul Gaultier

◆ Core Assortment

1088

Siz	PP-14	PP-15	PP-16	PP-17	PP-18	PP-19	PP-20	PP-21	PP-22	PP-23	PP-24	PP-25	PP-26	PP-27	PP-28	PP-29	PP-30	PP-31	PP-32	SS-18
-----	-------	-------	-------	-------	-------	-------	-------	-------	-------	-------	-------	-------	-------	-------	-------	-------	-------	-------	-------	-------

Crystal Lime (001 L125S)																					
Crystal Lotus Pink DeLite (001 L145D)																					
Crystal Mint Green (001 L115S)																					
Crystal Ocean DeLite (001 L143D)																					
Crystal Ochre DeLite (001 L131D)																					
Crystal Orange Glow DeLite (001 L146D)																					
Crystal Peach DeLite (001 L140D)																					
Crystal Peony Pink (001 L113S)								■													
Crystal Powder Blue (001 L104)								■			■									■	
Crystal Powder Green (001 L102)								■			■									■	
Crystal Powder Grey (001 L105)								■			■									■	
Crystal Powder Rose (001 L103)								■			■									■	
Crystal Powder Yellow (001 L101)								■			■									■	
Crystal Royal Blue (001 L110S)																					
Crystal Royal Blue DeLite (001 L110D)																					
Crystal Royal Green (001 L109S)																					
Crystal Royal Red (001 L107S)																					
Crystal Royal Red DeLite (001 L107D)																					
Crystal Silky Sage DeLite (001 L147D)																					
Crystal Summer Blue (001 L114S)																					
Crystal Sunshine DeLite (001 L141D)																					
Color Effects																					
Amethyst Ignite (204 IGNIT)																				■	
Aquamarine Ignite (202 IGNIT)																				■	
Black Diamond Shimmer F (215 SHIM)		■				■		■			■									■	
Emerald Ignite (205 IGNIT)																				■	
Erinite Shimmer F (360 SHIM)		■				■		■			■									■	
Light Colorado Topaz Ignite (246 IGNIT)																				■	
Light Colorado Topaz Shimmer F (246 SHIM)		■				■		■			■									■	
Light Rose Ignite (223 IGNIT)																				■	
Light Rose Shimmer F (223 SHIM)		■				■		■			■									■	
Light Sapphire Shimmer F (211 SHIM)		■				■		■			■									■	
Light Siam Shimmer F (227 SHIM)		■				■		■			■									■	
Light Topaz Shimmer F (226 SHIM)		■				■		■			■									■	
Scarlet Ignite (276 IGNIT)																				■	

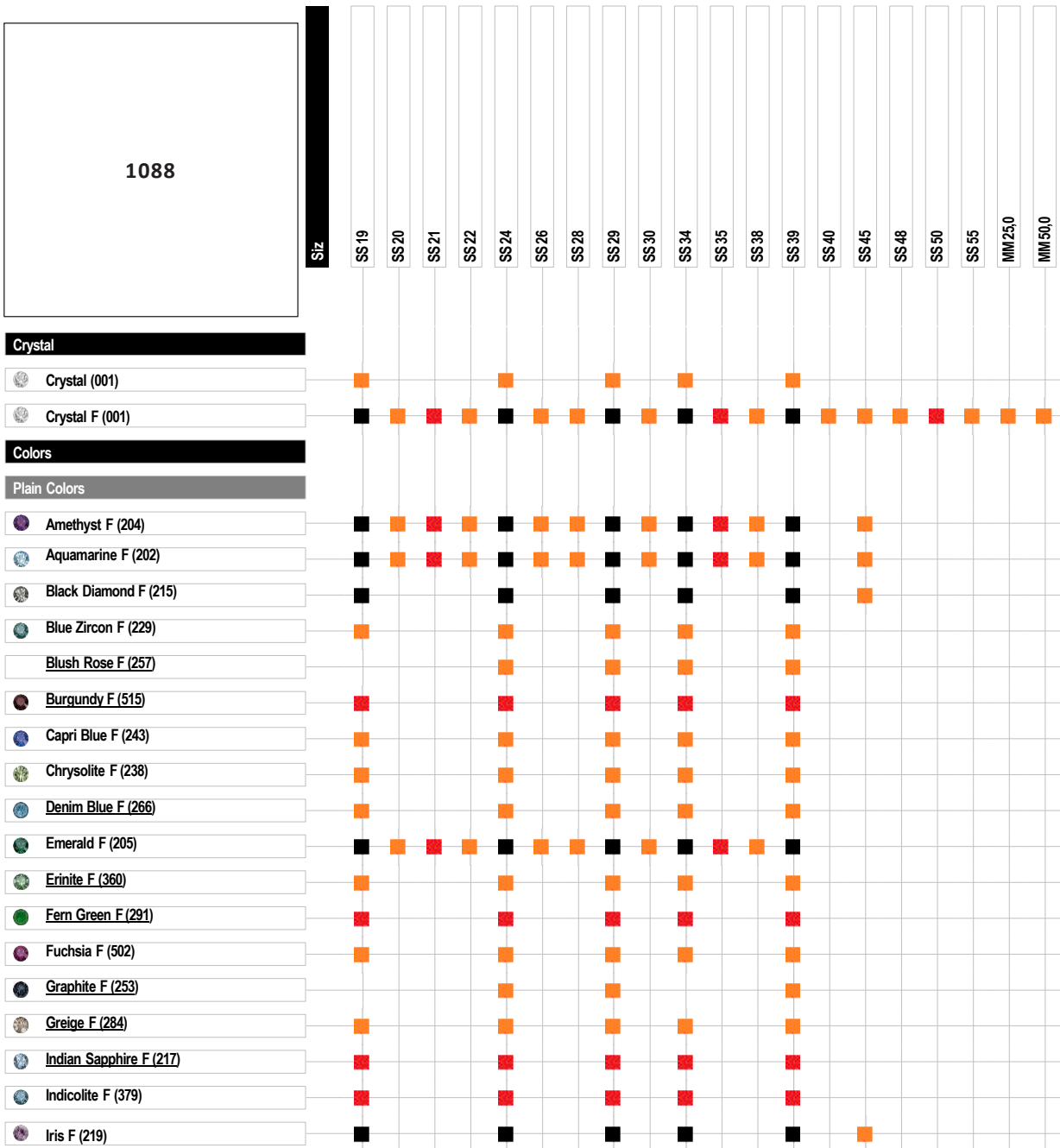
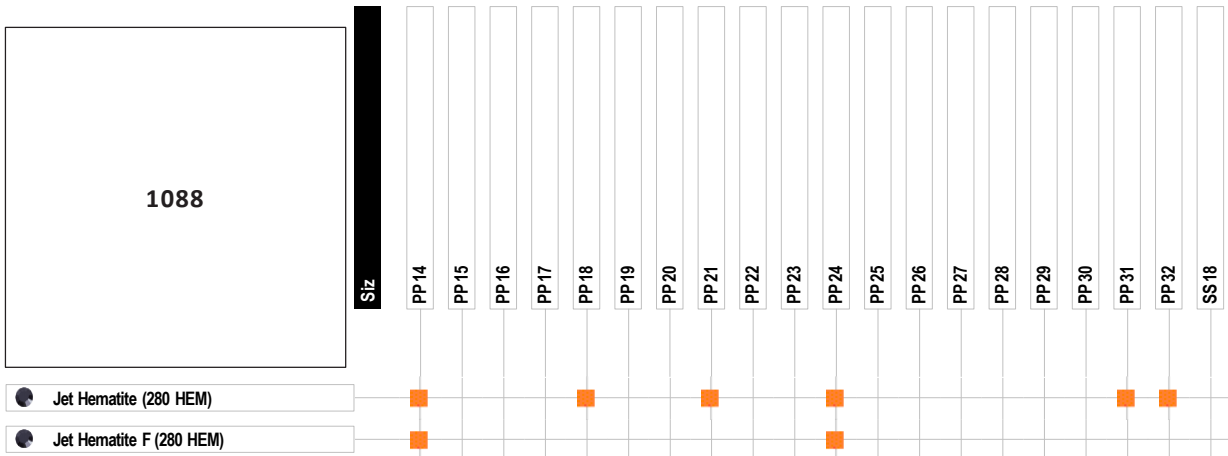

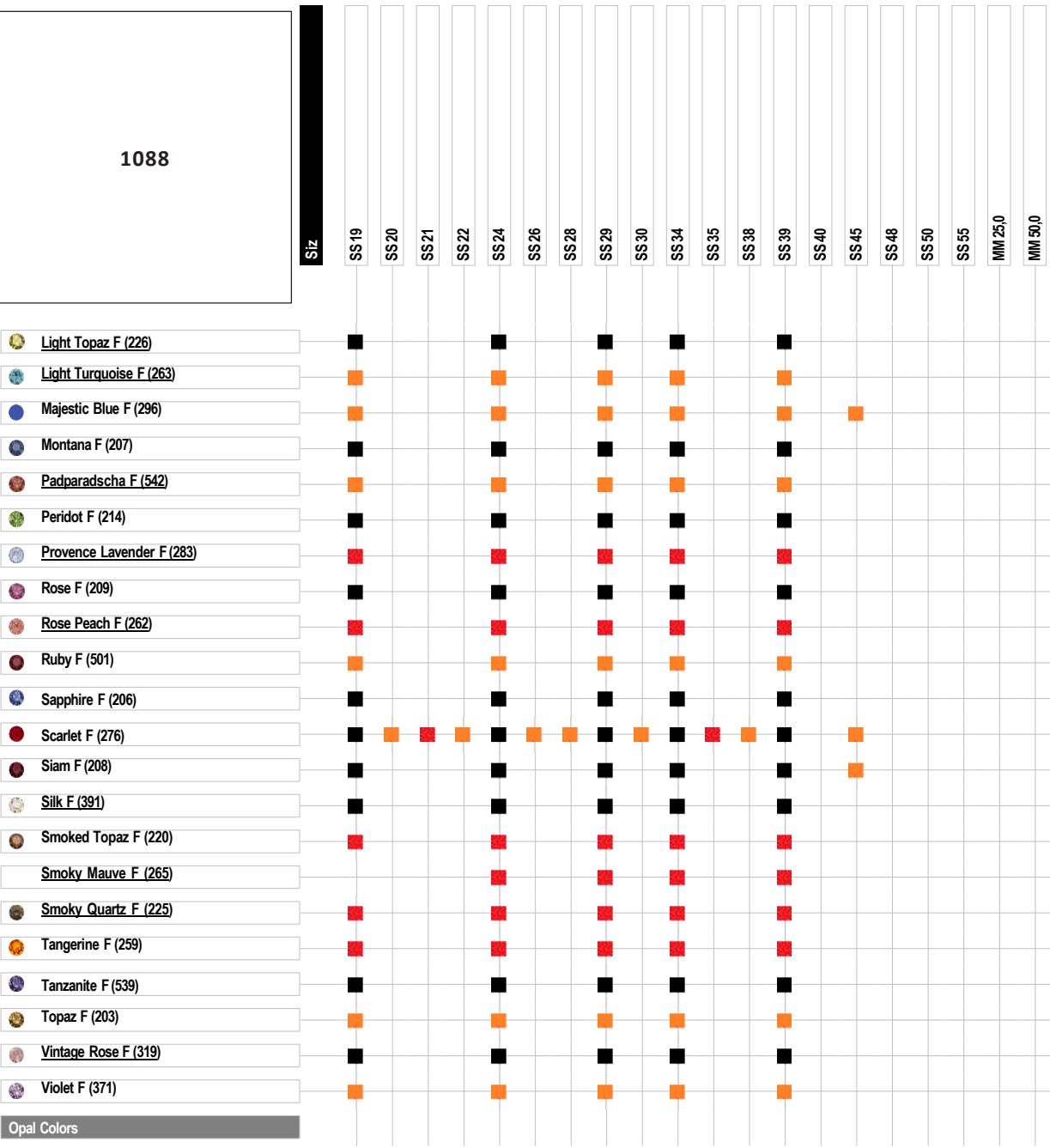
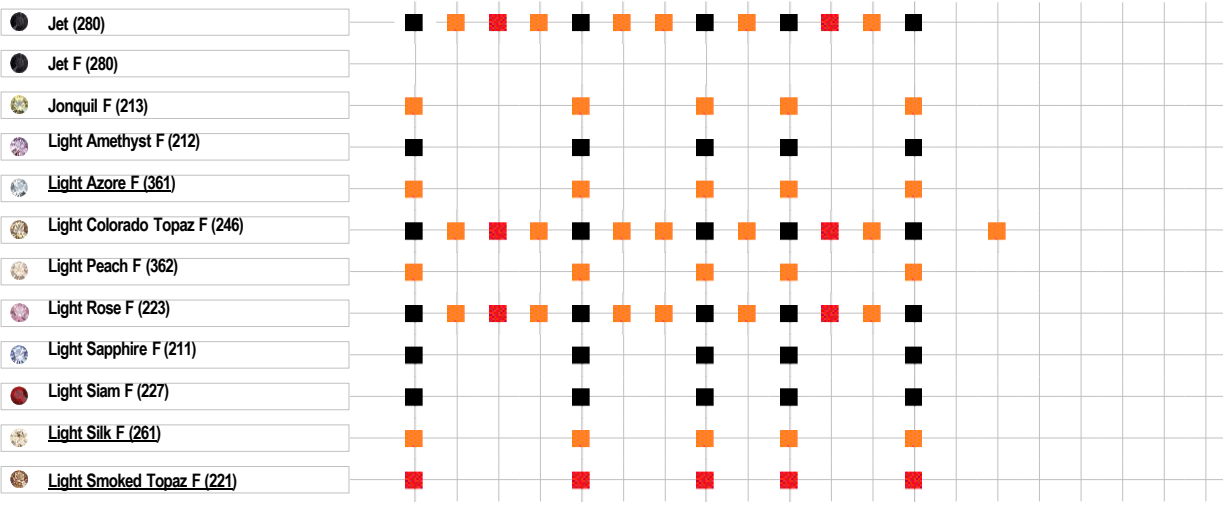

Air Blue Opal F (285)	■		■	■	■	■			
Light Grey Opal F (383)	■		■	■	■	■			
Pacific Opal F (390)	■		■	■	■	■			
Rose Water Opal F (395)	■		■	■	■	■			
White Opal F (234)	■		■	■	■	■			
Yellow Opal F (231)			■	■	■	■			
Crystal Effects									
Transparent Effects									
Crystal Antique Pink F (001 ANTP)	■		■	■	■	■			
Crystal AB F (001 AB)	■		■	■	■	■			
Crystal Blue Shade F (001 BLSH)	■		■	■	■	■			
Crystal Golden Shadow F (001 GSHA)	■		■	■	■	■			

1088	Size	SS 19	SS 20	SS 21	SS 22	SS 24	SS 26	SS 28	SS 29	SS 30	SS 34	SS 35	SS 38	SS 39	SS 40	SS 45	SS 48	SS 50	SS 55	MM 25.0	MM 50.0		
		Crystal Ignite (001 IGNIT)					■			■					■								
		Crystal Luminous Green F (001 LUMG)	■				■			■		■			■								
		Crystal Moonlight F (001 MOL)	■				■			■		■			■								
		Crystal Paradise Shine F (001 PARSH)					■			■		■			■								
		Crystal Silver Night F (001 SINI)	■				■			■		■			■								
		Crystal Silver Shade F (001 SSHA)	■				■			■		■			■								
		Metallic Effects																					
		Crystal Dorado F (001 DOR)	■				■			■		■			■								
		Crystal Light Chrome F (001 LTCH)					■			■		■			■								
		Crystal Metallic Blue F (001 METBL)	■				■			■		■			■								
		Crystal Metallic Light Gold F (001 MLGLD)	■				■			■		■			■								
		Crystal Metallic Sunshine F (001 METSH)					■			■		■			■								
		Crystal Rainbow Dark F (001 RABDK)								■		■			■								
		Crystal Rose Gold F (001 ROGL)	■				■			■		■			■								
		Crystal Scarabaeus Green F (001 SCGR)					■			■		■			■								
		Crystal Patina																					
Crystal Black Patina F (001 BLAPA)					■			■		■			■										
Crystal Gold Patina F (001 GOLPA)					■			■		■			■										
Crystal Rose Patina F (001 ROSPA)					■			■		■			■										
Crystal Silver Patina F (001 SILPA)					■			■		■			■										
Crystal White Patina F (001 WHIPA)					■			■		■			■										
Crystal Lacquer <sup>Pro</sup>																							
Crystal Army Green DeLite (001 L130D)									■				■										

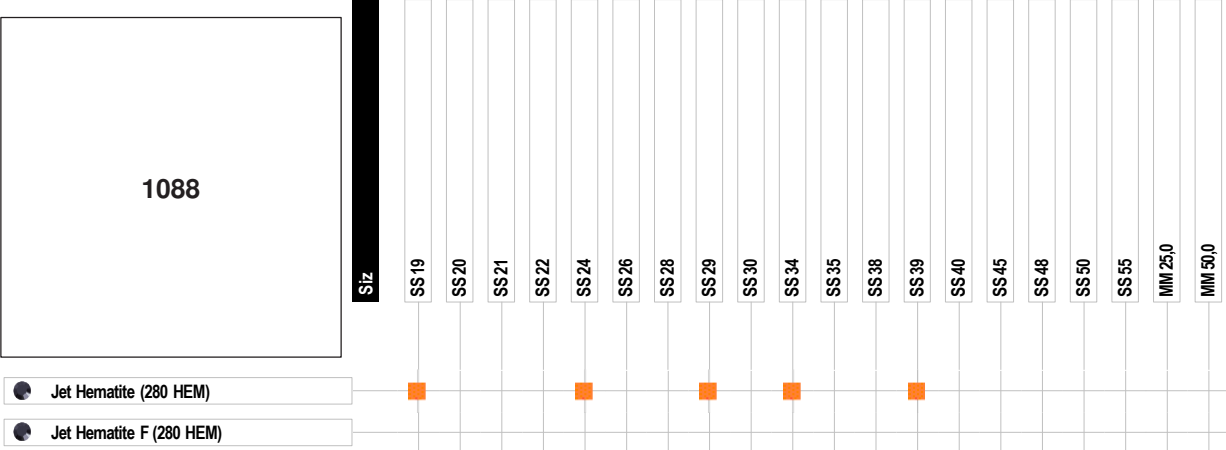
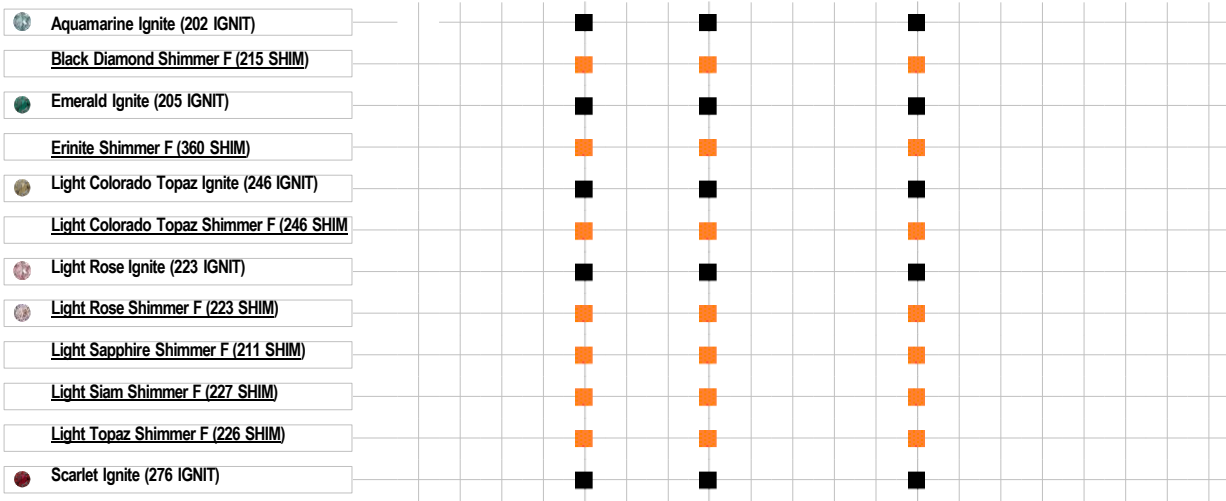

1088

Siz

SS 19 SS 20 SS 21 SS 22 SS 24 SS 26 SS 28 SS 29 SS 30 SS 34 SS 35 SS 38 SS 39 SS 40 SS 45 SS 48 SS 50 SS 55 MM 25.0 MM 50.0

CORE ASSORTMENT

1122 Rivoli

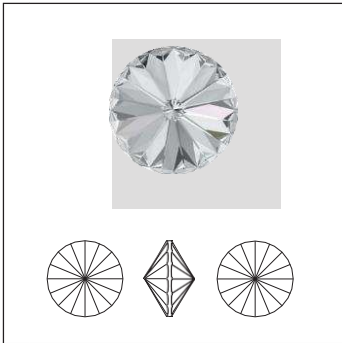

	SS 17	SS 24	SS 29	SS 34	SS 39	SS 47	MM 12,0	MM 14,0	MM 16,0	MM 18,0
Crystal										
Crystal (001)					■	■	■	■		
Crystal F (001)	■	■	■	■	■	■	■	■	■	■
Colors										
Plain Colors										
Amethyst F (204)			■	■	■	■	■	■		
Aquamarine F (202)			■	■	■	■	■	■		■
Black Diamond F (215)			■		■	■	■	■		■
Blue Zircon F (229)			■		■	■				
Blush Rose F (257)					■	■	■	■		
Chrysolite F (238)					■	■	■	■		
Denim Blue F (266)					■	■	■	■		
Emerald F (205)			■	■	■	■	■	■		
Fuchsia F (502)			■		■	■	■	■		
Graphite F (253)					■	■	■	■		
Iris F (219)			■		■	■	■	■		■
Jet (280)			■	■	■	■	■	■		
Light Amethyst F (212)			■		■	■	■	■		
Light Colorado Topaz F (246)			■	■	■	■	■	■		
Light Peach F (362)			■		■	■	■	■		
Light Rose F (223)			■	■	■	■	■	■		
Light Sapphire F (211)			■		■	■	■	■		
Light Siam F (227)			■		■	■	■	■		
Light Silk F (261)					■	■	■	■		
Light Turquoise F (263)					■	■	■	■		
Majestic Blue F (296)			■		■	■	■	■		■
Montana F (207)			■		■	■	■	■		
Olivine F (228)					■	■	■	■		
Padparadscha F (542)					■	■	■	■		
Peridot F (214)			■		■	■	■	■		
Rose F (209)			■		■	■	■	■		
Rose Peach F (262)					■	■	■	■		
Sapphire F (206)			■		■	■	■	■		■
Scarlet F (276)			■	■	■	■	■	■		■
Siam F (208)			■		■	■	■	■		

1122		Siz									
		SS17	SS24	SS29	SS34	SS39	SS47	MM12,0	MM14,0	MM16,0	MM18,0
	Silk F (391)					■	■	■	■		
	Smoked Topaz F (220)					■	■	■	■		
	Smoky Mauve F (265)					■	■	■	■		
	Tangerine F (259)					■	■	■			
	Tanzanite F (539)			■		■	■	■	■		
	Topaz F (203)					■	■	■	■		
	Vintage Rose F (319)					■	■	■	■		
	Violet F (371)			■		■	■	■	■		
Opal Colors											
	Yellow Opal F (231)					■	■	■	■		
Crystal Effects											
Transparent Effects											
	Crystal Antique Pink F (001 ANTP)					■	■	■	■		
	Crystal AB F (001 AB)	■	■	■	■	■	■	■	■	■	■
	Crystal Blue Shade F (001 BLSH)					■	■	■	■		
	Crystal Golden Shadow F (001 GSHA)			■		■	■	■	■		■
	Crystal Luminous Green F (001 LUMG)					■	■	■	■		
	Crystal Paradise Shine F (001 PARSH)					■	■	■	■		
	Crystal Silver Night F (001 SINI)					■	■	■	■		■
	Crystal Silver Shade F (001 SSHA)			■		■	■	■	■		■
	Crystal Vitrail Light F (001 VL)			■		■	■	■	■		■
	Crystal Vitrail Medium F (001 VM)			■		■	■	■	■		■
Metallic Effects											
	Crystal Metallic Sunshine F (001 METSH)					■	■	■	■		
	Crystal Rainbow Dark F (001 RABDK)			■		■	■	■	■		
	Crystal Rose Gold F (001 ROGL)					■	■	■	■		
	Crystal Scarabaeus Green F (001 SCGR)					■	■	■	■		
Crystal Patina											
	Crystal Black Patina F (001 BLAPA)					■	■	■	■		
	Crystal Gold Patina F (001 GOLPA)					■	■	■	■		
	Crystal Rose Patina F (001 ROSPA)					■	■	■	■		
	Crystal Silver Patina F (001 SILPA)					■	■	■	■		
	Crystal White Patina F (001 WHIPA)					■	■	■	■		
Crystal Lacquer ^{Pro}											
	Crystal Army Green DeLite (001 L130D)							■	■		

1122

	Siz	SS 17	SS 24	SS 29	SS 34	SS 39	SS 47	MM 12,0	MM 14,0	MM 16,0	MM 18,0
Crystal Azure Blue (001 L112S)								■	■		
Crystal Burgundy DeLite (001 L132D)								■	■		
Crystal Buttercup (001 L124S)								■	■		
Crystal Cappuccino DeLite (001 L133D)								■	■		
Crystal Dark Grey (001 L111S)								■	■		
Crystal Dark Red (001 L108S)								■	■		
Crystal Ivory Cream (001 L106S)								■	■		
Crystal Laguna DeLite (001 L142D)								■	■		
Crystal Lavender DeLite (001 L144D)								■	■		
Crystal Light Coral (001 L116S)								■	■		
Crystal Light Grey DeLite (001 L129D)								■	■		
Crystal Lilac (001 L126S)								■	■		
Crystal Lime (001 L125S)								■	■		
Crystal Lotus Pink DeLite (001 L145D)								■	■		
Crystal Mint Green (001 L115S)								■	■		
Crystal Ocean DeLite (001 L143D)								■	■		
Crystal Ochre DeLite (001 L131D)								■	■		
Crystal Orange Glow DeLite (001 L146D)								■	■		
Crystal Peach DeLite (001 L140D)								■	■		
Crystal Peony Pink (001 L113S)								■	■		
Crystal Royal Blue (001 L110S)								■	■		
Crystal Royal Blue DeLite (001 L110D)								■	■		
Crystal Royal Green (001 L109S)								■	■		
Crystal Royal Red (001 L107S)								■	■		
Crystal Royal Red DeLite (001 L107D)								■	■		
Crystal Silky Sage DeLite (001 L147D)								■	■		
Crystal Summer Blue (001 L114S)								■	■		
Crystal Sunshine DeLite (001 L141D)								■	■		
Color Effects											
Jet Hematite (280 HEM)			■	■	■	■	■	■	■		

1128

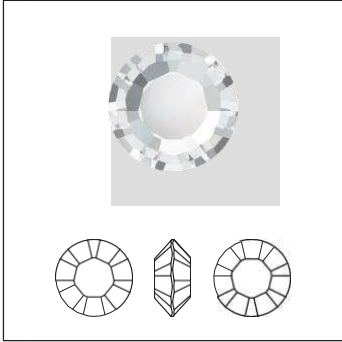

Siz	PP 32	SS 29	SS 39
-----	-------	-------	-------

Crystal

Crystal (001)	<input checked="" type="checkbox"/>	<input checked="" type="checkbox"/>	<input checked="" type="checkbox"/>
---------------	-------------------------------------	-------------------------------------	-------------------------------------

Colors

Plain Colors

Amethyst (204)	<input type="checkbox"/>	<input checked="" type="checkbox"/>	<input checked="" type="checkbox"/>
Emerald (205)	<input type="checkbox"/>	<input checked="" type="checkbox"/>	<input checked="" type="checkbox"/>
Light Amethyst (212)	<input type="checkbox"/>	<input checked="" type="checkbox"/>	<input checked="" type="checkbox"/>
Light Sapphire (211)	<input type="checkbox"/>	<input checked="" type="checkbox"/>	<input checked="" type="checkbox"/>
Peridot (214)	<input type="checkbox"/>	<input checked="" type="checkbox"/>	<input checked="" type="checkbox"/>
Rose (209)	<input type="checkbox"/>	<input checked="" type="checkbox"/>	<input checked="" type="checkbox"/>
Sapphire (206)	<input type="checkbox"/>	<input checked="" type="checkbox"/>	<input checked="" type="checkbox"/>
Siam (208)	<input type="checkbox"/>	<input checked="" type="checkbox"/>	<input checked="" type="checkbox"/>
Topaz (203)	<input type="checkbox"/>	<input checked="" type="checkbox"/>	<input checked="" type="checkbox"/>

1185 Pointed Chaton

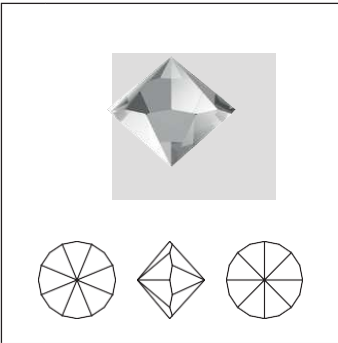

Size 1 mm

1185 Pointed Chaton

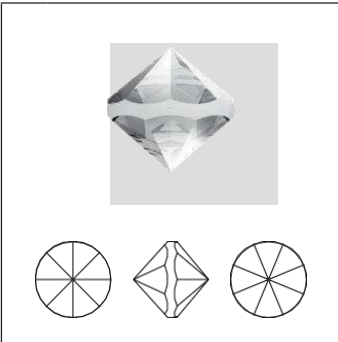

Size PP 9, 14, 22

1185	Size			
	MM 1,0	PP 9	PP 14	PP 22
Crystal				
Crystal (001)	■	■	■	■
Colors				
Plain Colors				
Amethyst (204)	■	■	■	■
Aquamarine (202)	■	■	■	■
Emerald (205)	■	■	■	■
Jet (280)	■	■	■	■
Light Colorado Topaz (246)	■	■	■	■
Light Rose (223)	■	■	■	■
Scarlet (276)	■	■	■	■
Crystal Effects				
Transparent Effects				
Crystal AB (001 AB)	■	■	■	■
Crystal Bermuda Blue (001 BB)	■	■	■	■
Crystal Golden Shadow (001 GSHA)	■	■	■	■
Crystal Silver Night (001 SINI)	■	■	■	■
Metallic Effects				
Crystal Light Chrome (001 LTCH)	■	■	■	■
Crystal Metallic Light Gold (001 MLGLD)	■	■	■	■

1188 XIRIUS Painted Chaton

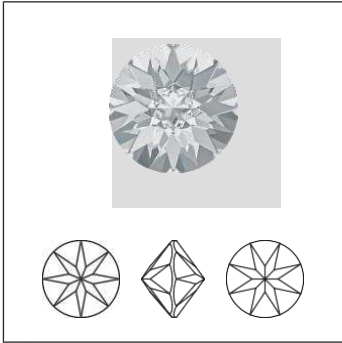

Siz	SS 17	SS 24	SS 29	SS 39
-----	-------	-------	-------	-------

Crystal

Crystal (001)	■	■	■	
Crystal F (001)	■	■	■	

Colors

Plain Colors

Aquamarine F (202)	■	■	■	
Black Diamond F (215)	■	■	■	
Jet (280)	■	■	■	
Light Siam F (227)	■	■	■	
Montana F (207)	■	■	■	
Rose F (209)	■	■	■	

Crystal Effects

Transparent Effects

Crystal AB F (001 AB)		■	■	■
Crystal Golden Shadow F (001 GSHA)		■	■	■
Crystal Luminous Green F (001 LUMG)	■	■	■	■
Crystal Silver Shade F (001 SSHA)		■	■	■

Metallic Effects

Crystal Rose Gold F (001 ROGL)		■	■	■
--------------------------------	--	---	---	---

1201

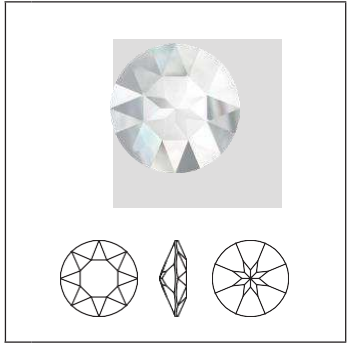

Siz

MM 27,0

MM 35,0

Crystal

Crystal (001)

Crystal F (001)

Crystal Effects

Transparent Effects

Crystal AB F (001 AB)

1318 FlowerCut

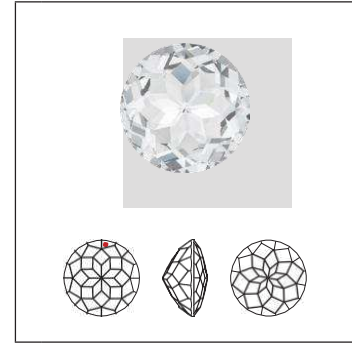

Siz

MM 30,0

MM 55,0

Crystal Effects

Metallic Effects

Crystal CAL V SI (001 CAVSI)

1357 BrilliantCut

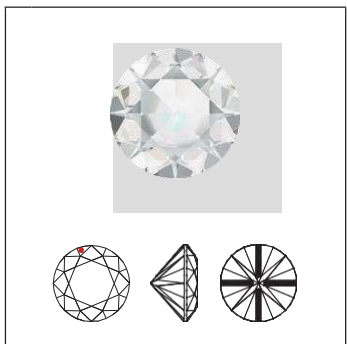

Siz

MM 20,0

MM 50,0

MM 80,0

Crystal Effects

Metallic Effects

Crystal CAL V SI (001 CAVSI)

¹ These articles are delivered with a laser-engraved logo.

• The logo position is marked by a red dot.

1400 Dome Round Stone



Siz	MM 10,0	MM 12,0	MM 14,0	MM 18,0
-----	---------	---------	---------	---------

Crystal

Crystal F (001)	■	■	■	■
-----------------	---	---	---	---

Colors

Plain Colors

Amethyst F (204)	■	■		
Aquamarine F (202)	■	■	■	■
Emerald F (205)	■	■	■	■
Iris F (219)	■	■	■	■
Jet (280)	■	■	■	■
Light Colorado Topaz F (246)	■	■	■	■
Scarlet F (276)	■	■	■	

Opal Colors

White Opal F (234)	■	■	■	■
--------------------	---	---	---	---

Crystal Effects

Transparent Effects

Crystal AB F (001 AB)	■	■	■	■
Crystal Bermuda Blue F (001 BB)	■	■	■	■
Crystal Paradise Shine F (001 PARSH)	■	■	■	■

ATELIER MUNSTEINER FOR SWAROVSKI

DESIGNER EDITION

VISION ROUND STONE

The new Vision Designer Edition marks the first ever collaboration between Swarovski and Atelier Munsteiner, a German design house renowned for its multi-award-winning gemstone cuts, fine jewelry, and sculptures. The family-owned company's third-generation master craftsmen have drawn upon many years of experience to develop this stunning crystal innovation exclusively for Swarovski.

The Vision Designer Edition combines the uncomplicated appeal of simple cuts with the playfulness of mirrored reflections. These

ingeniously crafted design elements bring to mind frozen water, with mysteriously encapsulated air bubbles forming a perfectly geometrical, flower-like shape within the crystal. It is available in three of the most popular shapes for Jewelry and Accessories – the round, square, and hexagon – offering endless design possibilities and making it ideal for use in Glamorous and Progressive creations.

It is the subtlety in the simplicity that makes this Designer Edition truly "VISIONARY."

DESIGNER EDITION

1681 Vision Round Stone

	MM 12,0	MM 16,0
Crystal		
Crystal F (001)	■	■
Colors		
Plain Colors		
Rose F (209)	■	■
Tanzanite F (539)	■	■
Crystal Effects		
Transparent Effects		
Crystal Antique Pink F (001 ANTP)	■	■
Crystal Astral Pink F (001 API)	■	■
Crystal Blue Shade F (001 BLSH)	■	■
Crystal Golden Shadow F (001 GSHA)	■	■
Crystal Silver Night F (001 SINI)	■	■

THE VISION DESIGNER EDITION FAMILY



1681 chapter01 RoundStones
12, 16 mm p. 122



4681 chapter02 FancyStones & Settings
14, 18 mm p. 179



1681/S chapter01 RoundStones
12, 16 mm p. 122



4681/S chapter02 FancyStones & Settings
14, 18 mm p. 179

DESIGNER EDITIONS – DISTINCT PACKAGING

This Designer Edition will be labeled with the
"Designer Edition" imprint directly on the packaging.

OCEAN MYSTERIES DESIGNED BY CÉLINE COUSTEAU

DESIGNER EDITION

Design Story: Above for the sea runs through her veins: Céline Cousteau is a celebrated filmmaker, humanitarian, and environmentalist, as well as the granddaughter of legendary ocean explorer Jacques-Yves Cousteau. She presents her first ever crystal designs for Swarovski, inspired by one of her favorite places, the depths of the ocean. Taking inspiration from nature itself and

leaving its beauty unaltered, her stunningly life-like creatures are not only captivating and spellbinding, they also draw attention toward the mysterious, mostly unseen, and unexplored world beneath the ocean's surface on which all ocean life depends. These mysteries need to be protected for future generations, both above and below the water.

1695 Sea Urchin Round Stone partly frosted

Category	Item	MM 10,0	MM 14,0
Crystal	Crystal F (001)	■	■
Colors	Opal Colors		
	White Opal F (234)	■	■
Crystal Effects	Crystal AB F (001 AB)	■	■
Transparent Effects	Crystal Bermuda Blue F (001 BB)	■	■
	Crystal Blue Shade F (001 BLSH)	■	■
	Crystal Golden Shadow F (001 GSHA)	■	■
	Crystal Luminous Green F (001 LUMG)	■	■
	Crystal Silver Night (001 SINI)	■	■
	Crystal Silver Shade F (001 SSHA)	■	■

DESIGNER EDITION

THE CÉLINE COUSTEAU DESIGNER EDITION FAMILY



1695
10, 14 mm

chapter01 RoundStones
p. 124



1695/S
10, 14 mm

chapter01 RoundStones
p. 124



4195
14, 18,
22 mm

chapter02 FancyStones & Settings
p. 143



4195/S
14, 18,
22 mm

chapter02 FancyStones & Settings
p. 143



6730
18x11.5,
34x22 mm

chapter06 Pendants
p. 348



6731
14, 28 mm

chapter06 Pendants
p. 349

DESIGNER EDITIONS – DISTINCT PACKAGING

This Designer Edition will be labeled with the
"Designer Edition" imprint directly on the packaging.

PRODUCT DETAILS

Article Size	Packing Unit = Minimum Order Quantity in Pieces	Average Net Weight in Gram per Packing Unit Crystal (001)	Average Gross Weight in Gram per Packing Unit Crystal (001)
1100			
PP0	1,440	0.4	9.0
PP1	1,440	0.6	9.1
1028			
PP2	1,440	0.7	11.6
PP3	1,440	1.1	11.8
PP4	1,440	1.4	12.2
PP5	1,440	1.8	12.6
PP6	1,440	2.1	13.3
PP7	1,440	2.3	13.6
PP8	1,440	2.8	14.8
PP9	1,440	3.4	17.7
PP10	1,440	3.8	15.2
PP11	1,440	4.7	16.4
PP12	1,440	5.6	17.5
PP13	1,440	6.7	19.2
1088			
PP14	1,440	7.1	18.1
PP15	1,440	7.3	19.5
PP16	1,440	8.5	21.0
PP17	1,440	9.0	22.4
PP18	1,440	12.0	23.8
PP19	1,440	12.1	25.3
PP20	1,440	14.6	28.2
PP21	1,440	15.8	29.6
PP22	1,440	16.9	31.0
PP23	1,440	19.6	33.9
PP24	1,440	24.4	36.8
PP25	1,440	25.4	41.1
PP26	1,440	27.8	44.0
PP27	1,440	30.2	46.9
PP28	1,440	33.8	51.2
PP29	1,440	36.2	54.1
PP30	1,440	39.9	58.4
PP31	1,440	49.2	64.2
PP32	1,440	53.7	69.9
SS 18	1,440	59.2	81.4
SS 19	1,440	66.2	91.5
SS 20	720	38.6	57.0
SS 21	720	42.9	62.0
SS 22	720	46.5	66.3
SS 24	720	61.1	79.3
SS 26	360	40.5	59.1
SS 28	360	48.0	68.1
SS 29	288	47.4	71.9
SS 30	288	38.6	75.5
SS 34	144	30.2	62.1
SS 35	144	36.4	65.6
SS 38	144	44.7	73.6
SS 39	144	52.9	74.7

Article Size	Packing Unit = Minimum Order Quantity in Pieces	Average Net Weight in Gram per Packing Unit Crystal (001)	Average Gross Weight in Gram per Packing Unit Crystal (001)
SS 40	144	47.1	81.5
SS 45	144	86.5	129.7
SS 48	144	118.5	169.0
SS 50	144	142.8	199.3
SS 55	72	96.5	135.7
25 mm	8	75.2	111.4
50 mm	2	127.1	181.5
1122			
SS 17	1,440	48.7	57.2
SS 24	720	47.0	66.9
SS 29	720	77.6	103.4
SS 34	360	58.5	80.6
SS 39	144	37.1	55.2
SS 47	288	158.6	215.9
12 mm	144	99.5	142.2
14 mm	144	167.4	225.9
16 mm	144	242.7	317.2
18 mm	72	181.7	244.0
1128			
PP32	1,440	57.9	79.9
SS 29	360	53.5	74.6
SS 39	144	49.5	69.9
1185			
1 mm	1,440	1.09	11.09
PP9	1,440	5.16	15.15
PP14	1,440	11.43	19.13
PP22	1,440	22.23	29.93
1188			
SS 17	1,440	53.4	62.3
SS 24	720	73.7	82.9
SS 29	288	52.1	66.4
SS 39	144	58.3	120.6
1201			
27 mm	24	174.3	245.6
35 mm	6	70.6	115.5
1318			
30 mm	24	373.8	723.0
55 mm	10	892.3	1,372.1
1357			
20 mm	30	148.4	383.0
50 mm	12	1,006.2	1,482.0
80 mm	4	1,078.3	1,760.0
1681			
12 mm	72	56.8	101.3
16 mm	48	84.5	127.3
1695			
10 mm	72	48.4	79.6
14 mm	36	61.4	102.7



FANCY STONES & SETTINGS

Fancy Stones are available in numerous shapes, ranging from classical gemstone-inspired cuts to progressive trend cuts. They come in a huge assortment of different sizes and colors. Showing either a faceted or flat reverse side, Fancy Stones can be glued into pre-cast cavities or used in metal settings. Their precision-cut facets ensure the highest brilliance and lend design ideas a unique sparkle.



Settings are unplated or plated brass components, each specifically tailored to a Fancy Stone, which secure the crystal and allow for a myriad of application possibilities, including, but not limited to, sewing, soldering, and gluing.

Communication on Product-Assortment changes*

IMPORTANT INFORMATION ON ASSORTMENT ADJUSTMENTS

We would kindly like to inform you about overall portfolio streamlining as well as discontinuations of selected product lines, effective as of November 23rd, 2020.

In order to allow you sufficient time to prepare, upcoming changes are already visible in our B2B e-commerce platform. During this transition phase the collection has been marked with the following caption:

Caption - SUMMARY	
	OUT OF ASSORTMENT
	CHANGES IN THE ASSORTMENT
	NO CHANGES IN THE ASSORTMENT

Caption - MATRIX	
	OUT OF ASSORTMENT
	FUTURE MADE TO ORDER ITEM - MTO
	FUTURE MADE TO STOCK ITEM - MTS

*ASSORTMENT WILL BE VALID DURING THE TRANSITION PHASE: **NOV 23rd 2020 – March 31st 2021**
SMALL CHANGES CAN ACCURE DURING THIS TRANSITION PHASE

SUMMARY

1	2	3	S		1	2	3	S		1	2	3	S	
				COREASSORTIMENT 4120 6x4, 8x6, 14x10, 18x13, 25x18 mm					4227 32x17 mm					4447 6, 8, 10, 12 mm
				4122 8x6, 14x10.5, 18x13.5 mm					COREASSORTIMENT 4228 4x2, 5x2.5, 6x3, 8x4, 10x5, 15x7 mm					4461 8, 12, 16 mm
				4127 30x22, 39x28 mm					4230 14x9, 19x12, 23x15 mm					COREASSORTIMENT 4470 8, 10, 12, 18 mm
				4128 6x4, 8x6, 10x8 mm					COREASSORTIMENT 4320 6x4, 8x6, 10x7, 14x10, 18x13 mm					4480 6, 8, 10 mm
				4137 15x11 mm					4322 10x5, 14x7, 18x9, 22x11, 30x15 mm					4485 6, 10.5, 17 mm
				4139 14, 20, 30 mm					4327 30x20, 40x27 mm					4500 3x2, 6x2, 10x3 mm
				4142 10x8, 14x11, 18x14 mm					4328 6x3.6, 8x4.8, 10x6, 13x7.8 mm					COREASSORTIMENT 4501 4x2, 5x2, 5x2.5, 7x3, 10x5 mm
				4161 15x5, 21x7, 27x9 mm					4331 11, 15, 20, 30 mm					4502 3x1 mm
				DESIGNER EDITION 4195 14, 18, 22 mm					4370 11x10, 15.5x14, 20x18 mm					4503 4x2, 6.3x2.4 mm
				4196 23x20, 30x26 mm					4418 6, 8 mm					4524 12x6, 16x8, 23x11 mm
				4200 11x3, 15x4, 35x9.5, 48x13 mm					COREASSORTIMENT 4428 1.5, 2, 3, 4, 5, 6, 8 mm					4527 8x6, 14x10, 18x13 mm
				4224 10x8, 14x11, 23x18 mm					4439 14, 20, 30 mm					4547 15x5, 21x7, 24x8, 30x10 mm

1 Top view 2 Side view 3 Back view SSetting
 ... Underlined measurements signify that a setting is available.

1	2	3	S	4565 14x10, 18x13 mm	1	2	3	S	4731 10x5, 14x7, 18x9, 23x11.5 mm	1	2	3	S	4784 8, 14, 23 mm
				4568 8x6, 14x10, 18x13, 27x18 mm					4739 14x11, 20x16 mm					4789 14 mm
				4600 6x4, 8x6, 10x8, 12x10 mm					4744 6, 10 mm					4790 18x7.5, 23x10 mm
				4610 14x10, 18x13, 20x15 mm					4745 5, 10 mm					4795 14, 19, 28 mm
				4627 27x18.5, 37x25.5 mm					4748 5, 10 mm					4809 13x12, 17x15.5, 27x25 mm
				4675 23 mm					4753 14, 18, 23 mm					4810 13x12 mm
				4678 8, 14, 23 mm					4754 8x8, 13x13.5, 18x18.5 mm					4827 28 mm
				DESIGNER EDITION										
				4681 14, 18 mm					4756 19x11.5, 27x16, 39x23.5 mm					4831 5.5x5, 8.8x8, 11x10 mm
				4706 7, 12, 17, 24 mm					4757 14x8.5, 19x11.5 mm					4841 4, 6, 8 mm
				4707 7.8x4.9, 13.6x8.6, 18.7x11.8, 24x15.2 mm					4773 14x7.5, 18x9.5, 28x15 mm					4869 4, 6, 8 mm
				4717 15.5, 21.5 mm					4775 10.5x18 mm					4876 18x11.5, 30x19 mm
				4722 4, 6, 8, 10 mm					4778 18x13.7 mm					4878 18x11.5, 30x19 mm

1	2	3	5	
				4884 <u>5.5x5, 6.6x6, 8.8x8,</u> <u>11x10 mm</u>
				DESIGNER EDITION 4921 <u>23x18, 29x22.5 mm</u>
				DESIGNER EDITION 4923 <u>28x24, 38x33 mm</u>
				DESIGNER EDITION 4925 <u>23x9, 29x11.5 mm</u>
				DESIGNER EDITION 4926 <u>14x10, 19x14 mm</u>
				DESIGNER EDITION 4927 <u>14x12, 19x17 mm</u>
				DESIGNER EDITION 4928 <u>12, 18 mm</u>
				DESIGNER EDITION 4929 <u>14x10.5, 24x17 mm</u>
				DESIGNER EDITION 4933 <u>19, 27 mm</u>

			4160 8x6, 10x8, 14x10, 18x13 mm
			4162 10x5.5, 14x7.5, 18x9.5 mm
			4460 8, 10, 14, 18 mm
			4483 <u>8, 10, 12, 14 mm</u>

			4595 <u>8x4, 12x6, 16x8,</u> <u>20x10 mm</u>
			4683 <u>7.8x8.7, 10x11.2,</u> <u>12x13.5, 14x15.8 mm</u>

			4883 <u>3.6x3.1 mm</u>
			4499 <u>6, 10, 14, 20 mm</u>
			4699 <u>6x6.9, 9.4x10.8,</u> <u>14x16, 20x22.9 mm</u>
			4799 <u>6x6.1, 9.2x9.4,</u> <u>14x14.3, 20x20.4 mm</u>

1 Top view 2 Side view 3 Back view **S**Setting
 ... Underlined measurements signify that a setting is available.

SETTINGS

ARTICLE EXPLANATION & ORDERING EXAMPLE

4120/S

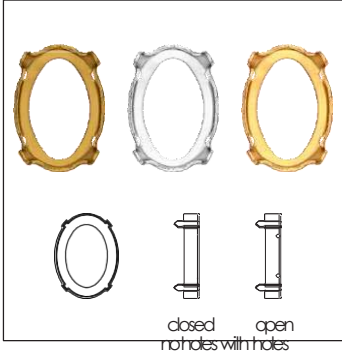

Size & color of plating	Material	Plating	Back configuration
6x4 mm No plating	1	P	H2 O
8x6 mm No plating	1	P	H2 O
14x10 mm No plating	1	P	H2 O
18x13 mm No plating	1	P	H2 O
25x18 mm No plating	1	P	H2 O
6x4 mm Rhodium	1	P	H2 O
8x6 mm Rhodium	1	P	H2 O
14x10 mm Rhodium	1	P	H2 O
18x13 mm Rhodium	1	P	H2 O
25x18 mm Rhodium	1	P	H2 O
6x4 mm Gold	1	P	H2 O
8x6 mm Gold	1	P	H2 O
14x10 mm Gold	1	P	H2 O
18x13 mm Gold	1	P	H2 O
25x18 mm Gold	1	P	H2 O

Ring/Hole, Back Configuration

00 C = No ring/hole, closed

H2 O = 4 holes/2 each side, open

4120/S	6x4 mm	1	P	H2	O	Z
Base item number	Stone Size	Material type	type	Hole configuration	Back configuration	Plating
	Same digit code as Fancy Stones	1 Brass 3 Tombac	P Non-gluing element	00 No Hole H2 Holes for sewing	C Closed O Open	Z No plating 3 Gold ¹ H Rhodium ¹

CORE ASSORTMENT

4120 Oval Fancy Stone



Siz	MM 4,0X 2,7	MM 6,0X 4,0	MM 8,0X 6,0	MM 14,0X 10,0	MM 18,0X 13,0	MM 25,0X 18,0
-----	-------------	-------------	-------------	---------------	---------------	---------------

Crystal

Crystal (001)		■	■	■	■	
Crystal F (001)	■	■	■	■	■	■

Colors

Plain Colors

Amethyst F (204)	■	■	■	■	■	
Aquamarine F (202)	■	■	■	■	■	
Black Diamond F (215)	■			■	■	■
Blush Rose F (257)		■	■	■	■	
Chrysolite F (238)			■	■	■	
Emerald F (205)	■	■	■	■	■	
Erinite F (360)			■	■	■	
Fuchsia F (502)		■	■	■	■	
Greige F (284)		■	■	■	■	
Indian Sapphire F (217)			■	■	■	
Indicolite F (379)		■	■	■	■	
Iris F (219)		■	■	■	■	
Jet (280)	■	■	■	■	■	■
Light Amethyst F (212)		■	■	■	■	
Light Azore F (361)			■	■	■	
Light Colorado Topaz F (246)	■	■	■	■	■	
Light Peach F (362)			■	■	■	
Light Rose F (223)		■	■	■	■	
Light Silk F (261)		■	■	■	■	
Light Smoked Topaz F (221)		■	■	■	■	
Light Turquoise F (263)		■	■	■	■	
Majestic Blue F (296)	■	■	■	■	■	■
Montana F (207)			■	■	■	
Padparadscha F (542)		■	■	■	■	
Provence Lavender F (283)		■	■	■	■	
Rose F (209)	■	■	■	■	■	
Rose Peach F (262)		■	■	■	■	
Sapphire F (206)		■	■	■	■	
Scarlet F (276)	■	■	■	■	■	■
Siam F (208)	■	■	■	■	■	

4120		Siz					
		MM 4,0X 2,7	MM 6,0X 4,0	MM 8,0X 6,0	MM 14,0X 10,0	MM 18,0X 13,0	MM 25,0X 18,0
Tanzanite F (539)		■	■	■	■	■	
Vintage Rose F (319)			■	■	■		
Violet F (371)				■	■	■	
Opal Colors							
Pacific Opal F (390)			■	■	■		
Rose Water Opal F (395)				■	■		
White Opal F (234)				■	■	■	
Crystal Effects							
Transparent Effects							
Crystal Antique Pink F (001 ANTP)		■	■	■	■		
Crystal AB F (001 AB)		■	■	■	■		
Crystal Blue Shade F (001 BLSH)		■	■	■	■		
Crystal Golden Shadow F (001 GSHA)		■	■	■	■	■	
Crystal Ignite (001 IGNIT)			■	■	■	■	
Crystal Paradise Shine F (001 PARSH)					■	■	
Crystal Silver Night F (001 SINI)			■	■	■	■	■
Crystal Silver Shade F (001 SSHA)			■	■	■	■	■
Crystal Patina							
Crystal Black Patina F (001 BLAPA)			■	■			
Crystal Gold Patina F (001 GOLPA)			■	■			
Crystal Rose Patina F (001 ROSPA)			■	■			
Crystal Silver Patina F (001 SILPA)			■	■			
Crystal White Patina F (001 WHIPA)			■	■			
Crystal Lacquer <sup>Pro</sup>							
Crystal Army Green DeLite (001 L130D)				■	■		
Crystal Azure Blue (001 L112S)				■	■		
Crystal Burgundy DeLite (001 L132D)				■	■		
Crystal Buttercup (001 L124S)				■	■		
Crystal Cappuccino DeLite (001 L133D)				■	■		
Crystal Dark Grey (001 L111S)				■	■		
Crystal Dark Red (001 L108S)				■	■		
Crystal Ivory Cream (001 L106S)				■	■		
Crystal Laguna DeLite (001 L142D)				■	■		
Crystal Lavender DeLite (001 L144D)				■	■		
Crystal Light Coral (001 L116S)				■	■		

4120		Siz					
		MM 4,0X 2,7	MM 6,0X 4,0	MM 8,0X 6,0	MM 14,0X 10,0	MM 18,0X 13,0	MM 25,0X 18,0
Crystal Light Grey DeLite (001 L129D)				■	■		
Crystal Lilac (001 L126S)				■	■		
Crystal Lime (001 L125S)				■	■		
Crystal Lotus Pink DeLite (001 L145D)				■	■		
Crystal Mint Green (001 L115S)				■	■		
Crystal Ocean DeLite (001 L143D)				■	■		
Crystal Ochre DeLite (001 L131D)				■	■		
Crystal Orange Glow DeLite (001 L146D)				■	■		
Crystal Peach DeLite (001 L140D)				■	■		
Crystal Peony Pink (001 L113S)				■	■		
Crystal Royal Blue (001 L110S)				■	■		
Crystal Royal Blue DeLite (001 L110D)				■	■		
Crystal Royal Green (001 L109S)				■	■		
Crystal Royal Red (001 L107S)				■	■		
Crystal Royal Red DeLite (001 L107D)				■	■		
Crystal Silky Sage DeLite (001 L147D)				■	■		
Crystal Summer Blue (001 L114S)				■	■		
Crystal Sunshine DeLite (001 L141D)				■	■		
Color Effects							
Amethyst Ignite (204 IGNIT)		■	■	■	■		
Aquamarine Ignite (202 IGNIT)		■	■	■	■		
Emerald Ignite (205 IGNIT)		■	■	■	■		
Light Colorado Topaz Ignite (246 IGNIT)		■	■	■	■		
Light Rose Ignite (223 IGNIT)		■	■	■	■		
Scarlet Ignite (276 IGNIT)		■	■	■	■		

4122 Oval Rivoli FancyStone

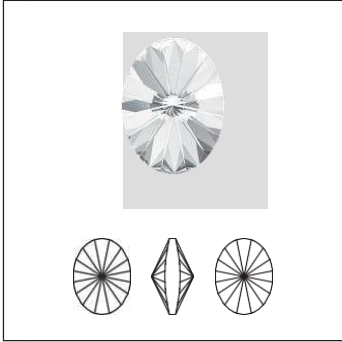

Siz	MM 8,0X 6,0	MM 14,0X 10,5	MM 18,0X 13,5
-----	-------------	---------------	---------------

Crystal

Crystal F (001)	■	■	■
-----------------	---	---	---

Colors

Plain Colors

Amethyst F (204)	■	■	■
Aquamarine F (202)	■	■	■
Emerald F (205)	■	■	■
Graphite F (253)	■	■	■
Jet (280)	■	■	■
Light Siam F (227)	■	■	■
Rose F (209)	■	■	■
Tanzanite F (539)	■	■	■

Crystal Effects

Transparent Effects

Crystal Antique Pink F (001 ANTP)	■	■	■
Crystal AB F (001 AB)	■	■	■
Crystal Blue Shade F (001 BLSH)	■	■	■
Crystal Golden Shadow F (001 GSHA)	■	■	■
Crystal Luminous Green F (001 LUMG)	■	■	■

Metallic Effects

Crystal Rainbow Dark F (001 RABDK)	■	■	■
------------------------------------	---	---	---

Crystal Lacquer ^{Pro}

Crystal Army Green DeLite (001 L130D)	■	■	■
Crystal Azure Blue (001 L112S)	■	■	■
Crystal Burgundy DeLite (001 L132D)	■	■	■
Crystal Buttercup (001 L124S)	■	■	■
Crystal Cappuccino DeLite (001 L133D)	■	■	■
Crystal Dark Grey (001 L111S)	■	■	■
Crystal Dark Red (001 L108S)	■	■	■
Crystal Ivory Cream (001 L106S)	■	■	■
Crystal Laguna DeLite (001 L142D)	■	■	■
Crystal Lavender DeLite (001 L144D)	■	■	■
Crystal Light Coral (001 L116S)	■	■	■
Crystal Light Grey DeLite (001 L129D)	■	■	■
Crystal Lilac (001 L126S)	■	■	■

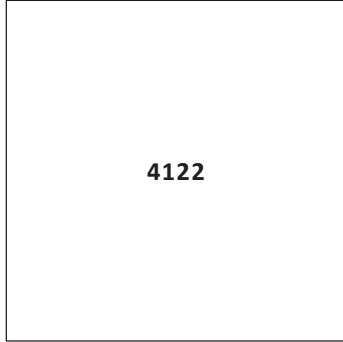

Siz	MM 8,0X 6,0	MM 14,0X 10,5	MM 18,0X 13,5
-----	-------------	---------------	---------------

Crystal Lime (001 L125S)	■	■	■
Crystal Lotus Pink DeLite (001 L145D)	■	■	■
Crystal Mint Green (001 L115S)	■	■	■
Crystal Ocean DeLite (001 L143D)	■	■	■
Crystal Ochre DeLite (001 L131D)	■	■	■
Crystal Orange Glow DeLite (001 L146D)	■	■	■
Crystal Peach DeLite (001 L140D)	■	■	■
Crystal Peony Pink (001 L113S)	■	■	■
Crystal Royal Blue (001 L110S)	■	■	■
Crystal Royal Blue DeLite (001 L110D)	■	■	■
Crystal Royal Green (001 L109S)	■	■	■
Crystal Royal Red (001 L107S)	■	■	■
Crystal Royal Red DeLite (001 L107D)	■	■	■
Crystal Silky Sage DeLite (001 L147D)	■	■	■
Crystal Summer Blue (001 L114S)	■	■	■
Crystal Sunshine DeLite (001 L141D)	■	■	■

4127

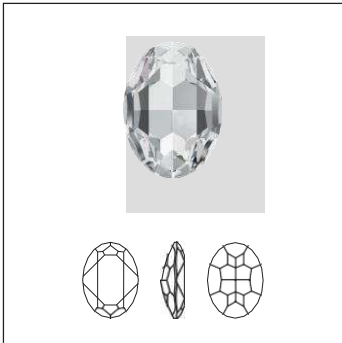

Siz
MM 30,0X 22,0
MM 39,0X 28,0

Crystal

Crystal F (001)

Colors

Plain Colors

Amethyst F (204)

Aquamarine F (202)

Black Diamond F (215)

Blush Rose F (257)

Burgundy F (515)

Chrysolite F (238)

Jet (280)

Light Colorado Topaz F (246)

Light Rose F (223)

Light Turquoise F (263)

Majestic Blue F (296)

Montana F (207)

Tanzanite F (539)

Opal Colors

White Opal F (234)

Crystal Effects

Transparent Effects

Crystal AB F (001 AB)

Crystal Golden Shadow F (001 GSHA)

Crystal Red Magma F (001 REDM)

Crystal Silver Shade F (001 SSHA)

Crystal Lacquer ^{Pro}

Crystal Army Green DeLite (001 L130D)

Crystal Azure Blue (001 L112S)

Crystal Burgundy DeLite (001 L132D)

Crystal Buttercup (001 L124S)

Crystal Cappuccino DeLite (001 L133D)

Crystal Dark Grey (001 L111S)

Crystal Dark Red (001 L108S)

Crystal Ivory Cream (001 L106S)

Crystal Laguna DeLite (001 L142D)

7

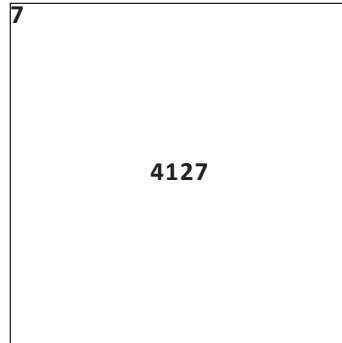

Siz
MM 30,0X 22,0
MM 39,0X 28,0

Crystal Lavender DeLite (001 L144D)

Crystal Light Coral (001 L116S)

Crystal Light Grey DeLite (001 L129D)

Crystal Lilac (001 L126S)

Crystal Lime (001 L125S)

Crystal Lotus Pink DeLite (001 L145D)

Crystal Mint Green (001 L115S)

Crystal Ocean DeLite (001 L143D)

Crystal Ochre DeLite (001 L131D)

Crystal Orange Glow DeLite (001 L146D)

Crystal Peach DeLite (001 L140D)

Crystal Peony Pink (001 L113S)

Crystal Royal Blue (001 L110S)

Crystal Royal Blue DeLite (001 L110D)

Crystal Royal Green (001 L109S)

Crystal Royal Red (001 L107S)

Crystal Royal Red DeLite (001 L107D)

Crystal Silky Sage DeLite (001 L147D)

Crystal Summer Blue (001 L114S)

Crystal Sunshine DeLite (001 L141D)

4128 XILION Oval Fancy Stone



Siz	MM 6,0X 4,0	MM 8,0X 6,0	MM 10,0X 8,0
-----	-------------	-------------	--------------

Crystal

Crystal F (001)	■	■	■
-----------------	---	---	---

Colors

Plain Colors

Amethyst F (204)	■	■	■
Aquamarine F (202)	■	■	■
Black Diamond F (215)	■	■	■
Denim Blue F (266)	■	■	■
Emerald F (205)	■	■	■
Light Amethyst F (212)	■	■	■
Light Rose F (223)	■	■	■
Montana F (207)	■	■	■
Rose F (209)	■	■	■
Scarlet F (276)	■	■	■
Siam F (208)	■	■	■

Crystal Effects

Transparent Effects

Crystal Golden Shadow F (001 GSHA)	■	■	■
------------------------------------	---	---	---

4137 Cosmic Oval Fancy Stone

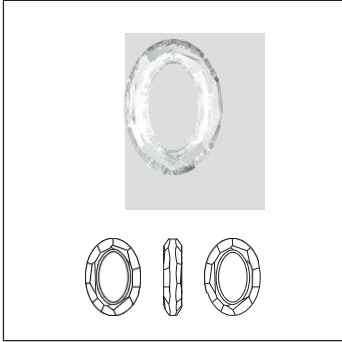

Siz
MM 15,0X 11,0

Colors

Plain Colors

● Jet (280)

Crystal Effects

Metallic Effects

Crystal CAL V SI (001 CAVSI)

4139 Cosmic Ring Fancy Stone

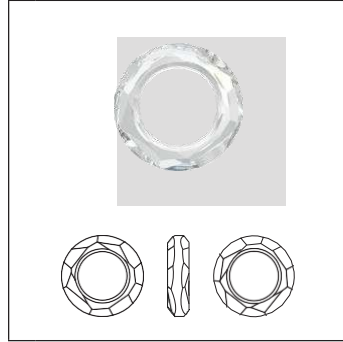

Siz
MM 14,0
MM 20,0
MM 30,0

Crystal

● Crystal (001)

Crystal Effects

Transparent Effects

● Crystal AB (001 AB)

● Crystal Bermuda Blue (001 BB)

● Crystal Golden Shadow (001 GSHA)

● Crystal Vitrail Light (001 VL)

● Crystal Volcano (001 VOL)

Metallic Effects

Crystal CAL V SI (001 CAVSI)

4142 Baroque Mirror Fancy Stone

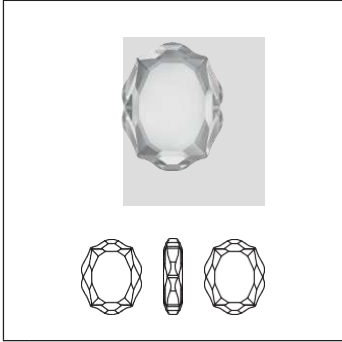

Siz	MM 10,0X 8,0	MM 14,0X 11,0	MM 18,0X 14,0
-----	--------------	---------------	---------------

Crystal

Crystal F (001)	■	■	■
-----------------	---	---	---

Colors

Plain Colors

Amethyst F (204)	■	■	■
Blush Rose F (257)	■	■	■
Denim Blue F (266)	■	■	■
Emerald F (205)	■	■	■

Crystal Effects

Transparent Effects

Crystal AB F (001 AB)	■	■	■
Crystal Golden Shadow F (001 GSHA)	■	■	■
Crystal Silver Night (001 SINI)	■	■	■

Metallic Effects

Crystal Light Chrome F (001 LTCH)	■	■	■
Crystal Metallic Light Gold F (001 MLGLD)	■	■	■
Crystal Rose Gold F (001 ROGL)	■	■	■

4160 Mystic Oval FS

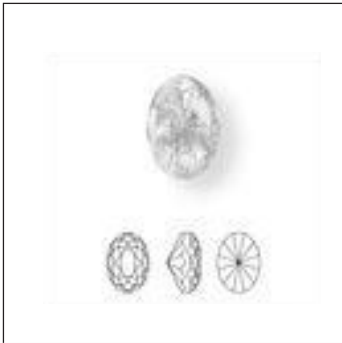

	Siz			
	MM 8,0X 6,0	MM 10,0X 8,0	MM 14,0X 10,0	MM 18,0X 13,0
Crystal				
Crystal F (001)	■	■	■	■
Colors				
Plain Colors				
Amethyst F (204)	■	■	■	■
Aquamarine F (202)	■	■	■	■
Emerald F (205)	■	■	■	■
Iris F (219)	■	■	■	■
Light Colorado Topaz F (246)	■	■	■	■
Scarlet F (276)	■	■	■	■
Crystal Effects				
Transparent Effects				
Crystal Astral Pink F (001 API)	■	■	■	■
Crystal AB F (001 AB)	■	■	■	■
Crystal Luminous Green F (001 LUMG)	■	■	■	■
Crystal Paradise Shine F (001 PARSH)	■	■	■	■
Crystal Vitrail Medium F (001 VM)	■	■	■	■
Color Effects				
Light Topaz Shimmer F (226 SHIM)	■	■	■	■

4161 Long Classical Oval FS

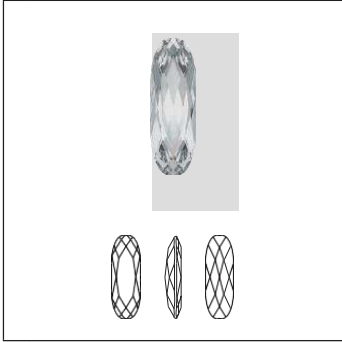

Size	MM 15,0X 5,0	MM 21,0X 7,0	MM 27,0X 9,0
------	--------------	--------------	--------------

Crystal

Crystal F (001)	■	■	■
-----------------	---	---	---

Colors

Plain Colors

Amethyst F (204)	■	■	
Aquamarine F (202)	■	■	
Indicolite F (379)	■	■	
Light Colorado Topaz F (246)	■	■	
Light Rose F (223)	■	■	
Light Turquoise F (263)	■	■	
Majestic Blue F (296)	■	■	■
Olivine F (228)	■	■	

4162 ELONGATED OVALS



Size	MM 10,0X 5,5	MM 14,0X 7,5	MM 18,0X 9,5
------	--------------	--------------	--------------

Crystal

Crystal F (001)	<input checked="" type="checkbox"/>	<input checked="" type="checkbox"/>	<input checked="" type="checkbox"/>
-----------------	-------------------------------------	-------------------------------------	-------------------------------------

Colors

Plain Colors

Amethyst F (204)	<input checked="" type="checkbox"/>	<input checked="" type="checkbox"/>	<input checked="" type="checkbox"/>
Aquamarine F (202)	<input checked="" type="checkbox"/>	<input checked="" type="checkbox"/>	<input checked="" type="checkbox"/>
Emerald F (205)	<input checked="" type="checkbox"/>	<input checked="" type="checkbox"/>	<input checked="" type="checkbox"/>
Iris F (219)	<input checked="" type="checkbox"/>	<input checked="" type="checkbox"/>	<input checked="" type="checkbox"/>
Jet (280)	<input checked="" type="checkbox"/>	<input checked="" type="checkbox"/>	<input checked="" type="checkbox"/>
Light Colorado Topaz F (246)	<input checked="" type="checkbox"/>	<input checked="" type="checkbox"/>	<input checked="" type="checkbox"/>
Majestic Blue F (296)	<input checked="" type="checkbox"/>	<input checked="" type="checkbox"/>	<input checked="" type="checkbox"/>
Montana F (207)	<input checked="" type="checkbox"/>	<input checked="" type="checkbox"/>	<input checked="" type="checkbox"/>
Scarlet F (276)	<input checked="" type="checkbox"/>	<input checked="" type="checkbox"/>	<input checked="" type="checkbox"/>
Vintage Rose F (319)	<input checked="" type="checkbox"/>	<input checked="" type="checkbox"/>	<input checked="" type="checkbox"/>

Crystal Effects

Transparent Effects

Crystal AB F (001 AB)	<input checked="" type="checkbox"/>	<input checked="" type="checkbox"/>	<input checked="" type="checkbox"/>
Crystal Golden Shadow F (001 GSHA)	<input checked="" type="checkbox"/>	<input checked="" type="checkbox"/>	<input checked="" type="checkbox"/>
Crystal Silver Shade F (001 SSHA)	<input checked="" type="checkbox"/>	<input checked="" type="checkbox"/>	<input checked="" type="checkbox"/>

OCEAN MYSTERIES DESIGNED BY CÉLINE COUSTEAU

DESIGNER EDITION

Design Story: Above for the sea runs through her veins: Céline Cousteau is a celebrated filmmaker, humanitarian, and environmentalist, as well as the granddaughter of legendary ocean explorer Jacques-Yves Cousteau. She presents her first ever crystal designs for Swarovski, inspired by one of her favorite places, the depths of the ocean. Taking inspiration from nature itself and

leaving its beauty unaltered, her stunningly life-like creatures are not only captivating and spellbinding, they also draw attention toward the mysterious, mostly unseen, and unexplored world beneath the ocean's surface on which all ocean life depends. These mysteries need to be protected for future generations, both above and below the water.

4195 Jelly Fish Fancy Stone partly frosted

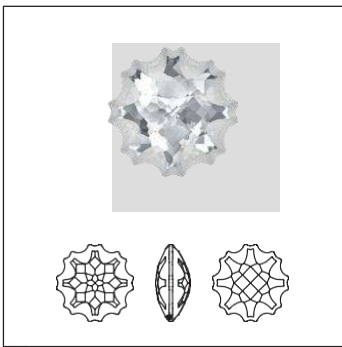

Size	MM14,0	MM18,0	MM22,0
Crystal			
Crystal F (001)	■	■	■
Crystal Effects			
Transparent Effects			
Crystal AB F (001 AB)	■		
Crystal Bermuda Blue F (001 BB)	■	■	■
Crystal Golden Shadow F (001 GSHA)	■		

THE CÉLINE COUSTEAU DESIGNER EDITION FAMILY



1695
10, 14 mm

chapter01 RoundStones
p. 124



6730
18x11.5,
34x22 mm

chapter06 Pendants
p. 348



1695/S
10, 14 mm

chapter01 RoundStones
p. 124



6731
14, 28 mm

chapter06 Pendants
p. 349



4195
14, 18,
22 mm

chapter02 FancyStones & Settings
p. 143



4195/S
14, 18,
22 mm

chapter02 FancyStones & Settings
p. 143

DESIGNER EDITIONS – DISTINCT PACKAGING

This Designer Edition will be labeled with the
"Designer Edition" imprint directly on the packaging.

4196 Nautilus Fancy Stone

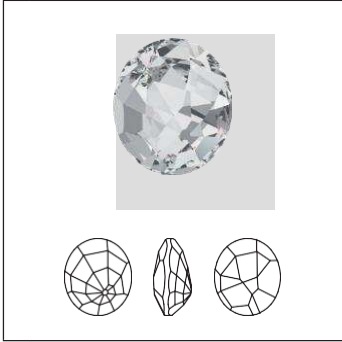

Siz	
MM 23,0X 20,0	
MM 30,0X 26,0	

Crystal

Crystal F (001)

Colors

Plain Colors

Black Diamond F (215)

Light Amethyst F (212)

Montana F (207)

4200 Sphinx Eye Fancy Stone

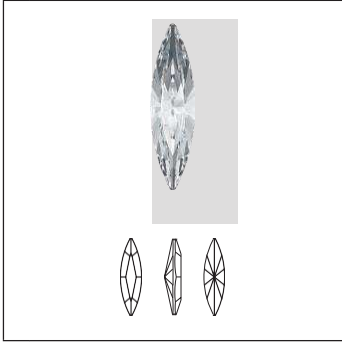

Size	MM 11,0X 3,0	MM 15,0X 4,0	MM 35,0X 9,5	MM 48,0X 13,0
------	--------------	--------------	--------------	---------------

Crystal

Crystal F (001)	■	■	■	■
-----------------	---	---	---	---

Colors

Plain Colors

Denim Blue F (266)				■
--------------------	--	--	--	---

Jet (280)	■	■	■	
-----------	---	---	---	--

Crystal Effects

Transparent Effects

Crystal Golden Shadow F (001 GSHA)	■	■	■	
------------------------------------	---	---	---	--

Crystal Silver Shade F (001 SSHA)			■	
-----------------------------------	--	--	---	--

4224 PureLeafFancyStone

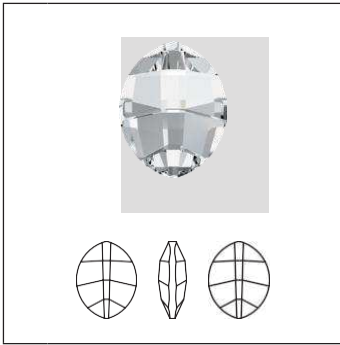

Size 10x8, 14x11 mm

4224 PureLeafFancyStone

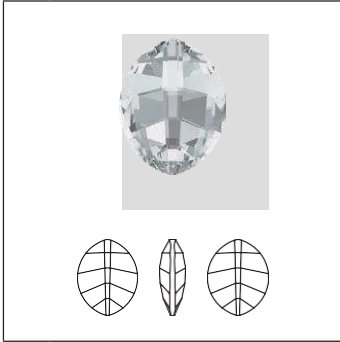

Size 23x18 mm

4224	Size	MM 10,0X 8,0	MM 14,0X 11,0	MM 23,0X 18,0
	Crystal	Crystal F (001)		
	Colors	Plain Colors		
	Amethyst F (204)	Emerald F (205)		
Crystal Effects	Transparent Effects			
	Crystal Blue Shade F (001 BLSH)			

4227 Wide Navette Fancy Stone

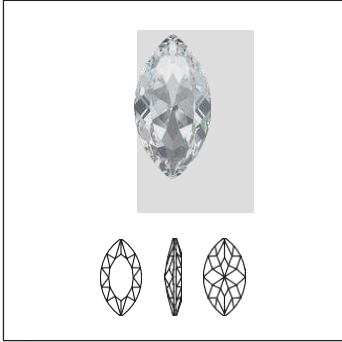

Siz

MM 32,0X 17,0

Crystal

Crystal F (001)

Crystal Effects

Transparent Effects

Crystal AB F (001 AB)

Crystal Golden Shadow F (001 GSHA)

Crystal Silver Shade F (001 SSHA)

CORE ASSORTMENT

4228 XILION Navette Fancy Stone

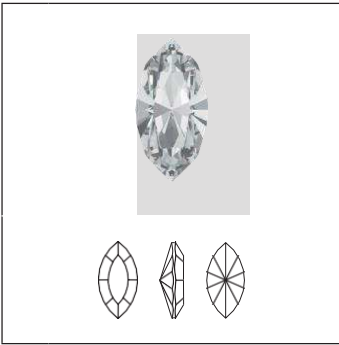

Size 4x2, 5x2.5mm

4228 XILION Navette Fancy Stone

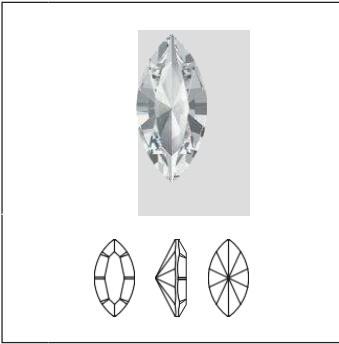

Size 6x3, 8x4, 10x5, 15x7mm

4228	Siz					
	MM 4,0X 2,0	MM 5,0X 2,5	MM 6,0X 3,0	MM 8,0X 4,0	MM 10,0X 5,0	MM 15,0X 7,0
Crystal						
Crystal F (001)	■	■	■	■	■	■
Colors						
Plain Colors						
Amethyst F (204)	■	■	■	■	■	■
Aquamarine F (202)	■	■	■	■	■	■
Black Diamond F (215)	■	■	■	■	■	■
Blush Rose F (257)			■	■	■	■
Denim Blue F (266)			■	■	■	■
Emerald F (205)	■	■	■	■	■	■
Erinte F (360)					■	■
Fuchsia F (502)	■	■	■	■	■	■
Graphite F (253)	■	■	■	■	■	■
Greige F (284)			■	■	■	■
Indicolite F (379)	■	■	■	■	■	■
Iris F (219)			■	■	■	■
Jet (280)	■	■	■	■	■	■
Jonquil F (213)	■	■	■	■	■	■
Light Amethyst F (212)	■	■	■	■	■	■
Light Colorado Topaz F (246)	■	■	■	■	■	■
Light Rose F (223)	■	■	■	■	■	■
Light Sapphire F (211)	■	■	■	■	■	■
Light Siam F (227)	■	■	■	■	■	■
Light Silk F (261)	■	■	■	■	■	■
Light Topaz F (226)			■	■	■	■
Light Turquoise F (263)	■	■	■	■	■	■
Majestic Blue F (296)	■	■	■	■	■	■
Montana F (207)	■	■	■	■	■	■
Padparadscha F (542)			■	■	■	■
Peridot F (214)	■	■	■	■	■	■
Provence Lavender F (283)			■	■	■	■
Rose F (209)	■	■	■	■	■	■
Rose Peach F (262)	■	■	■	■	■	■
Sapphire F (206)			■	■	■	■
Scarlet F (276)	■	■	■	■	■	■

4228	Siz					
	MM 4,0X 2,0	MM 5,0X 2,5	MM 6,0X 3,0	MM 8,0X 4,0	MM 10,0X 5,0	MM 15,0X 7,0
Siam F (208)	■		■	■	■	■
Smoked Topaz F (220)	■	■	■	■	■	■
Tangerine F (259)			■	■	■	■
Tanzanite F (539)	■		■	■	■	■
Opal Colors						
Chrysolite Opal F (294)	■	■	■	■	■	■
Pacific Opal F (390)			■	■	■	■
White Opal F (234)	■		■	■	■	■
Crystal Effects						
Transparent Effects						
Crystal Antique Pink F (001 ANTP)			■	■	■	■
Crystal AB F (001 AB)	■		■	■	■	■
Crystal Blue Shade F (001 BLSH)	■	■	■	■	■	■
Crystal Golden Shadow F (001 GSHA)	■	■	■	■	■	■
Crystal Ignite (001 IGNIT)			■	■	■	■
Crystal Luminous Green F (001 LUMG)			■	■	■	■
Crystal Paradise Shine F (001 PARSH)			■	■	■	■
Crystal Silver Night F (001 SINI)	■		■	■	■	■
Crystal Silver Shade F (001 SSHA)	■	■	■	■	■	■
Metallic Effects						
Crystal Rose Gold F (001 ROGL)			■	■	■	■
Crystal Lacquer <sup>Pro</sup>						
Crystal Dusty Pink DeLite (001 L149D)					■	
Crystal Ivory Cream DeLite (001 L106D)					■	
Crystal Laguna DeLite (001 L142D)					■	
Crystal Lavender DeLite (001 L144D)					■	
Crystal Lotus Pink DeLite (001 L145D)					■	
Crystal Ocean DeLite (001 L143D)					■	
Crystal Orange Glow DeLite (001 L146D)					■	
Crystal Peach DeLite (001 L140D)					■	
Crystal Royal Blue DeLite (001 L110D)					■	
Crystal Royal Red DeLite (001 L107D)					■	
Crystal Serene Gray DeLite (001 L150D)					■	
Crystal Silky Sage DeLite (001 L147D)					■	
Crystal Sunshine DeLite (001 L141D)					■	

4228	Siz					
	MM 4,0X 2,0	MM 5,0X 2,5	MM 6,0X 3,0	MM 8,0X 4,0	MM 10,0X 5,0	MM 15,0X 7,0
Color Effects						
Amethyst Ignite (204 IGNIT)			■	■	■	■
Aquamarine Ignite (202 IGNIT)			■	■	■	■
Black Diamond Shimmer F (215 SHIM)				■	■	■
Emerald Ignite (205 IGNIT)			■	■	■	■
Erinite Shimmer F (360 SHIM)				■	■	
Light Colorado Topaz Ignite (246 IGNIT)				■	■	■
Light Colorado Topaz Shimmer F (246 SHIM)				■	■	■
Light Rose Ignite (223 IGNIT)				■	■	■
Light Rose Shimmer F (223 SHIM)				■	■	■
Light Sapphire Shimmer F (211 SHIM)				■	■	■
Light Siam Shimmer F (227 SHIM)				■	■	■
Light Topaz Shimmer F (226 SHIM)				■	■	■
Scarlet Ignite (276 IGNIT)				■	■	■
Jet Hematite (280 HEM)	■	■	■	■	■	■

4230 LemonFancyStone

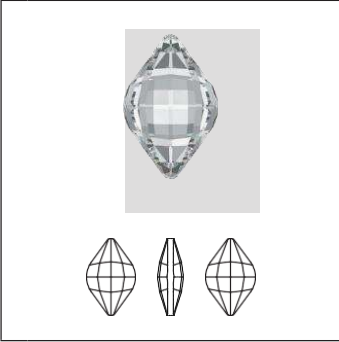

Siz	MM 14,0X 9,0	MM 19,0X 12,0	MM 23,0X 15,0
Crystal			
Crystal F (001)	■	■	■
Colors			
Plain Colors			
Amethyst F (204)	■	■	■
Aquamarine F (202)	■	■	■
Erinite F (360)	■	■	■
Light Silk F (261)	■	■	■
Crystal Effects			
Transparent Effects			
Crystal Antique Pink F (001 ANTP)	■	■	■
Crystal Blue Shade F (001 BLSH)	■	■	■
Crystal Golden Shadow F (001 GSHA)	■	■	■
Crystal Silver Night F (001 SINI)	■	■	■

Crystal

Crystal F (001)

Colors

Plain Colors

Amethyst F (204)

Aquamarine F (202)

Erinite F (360)

Light Silk F (261)

Crystal Effects

Transparent Effects

Crystal Antique Pink F (001 ANTP)

Crystal Blue Shade F (001 BLSH)

Crystal Golden Shadow F (001 GSHA)

Crystal Silver Night F (001 SINI)

CORE ASSORTMENT

4320 Pear Fancy Stone

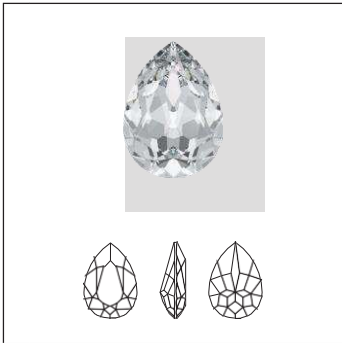

Size	MM 4,0X 2,9	MM 6,0X 4,0	MM 8,0X 6,0	MM 10,0X 7,0	MM 14,0X 10,0	MM 18,0X 13,0
------	-------------	-------------	-------------	--------------	---------------	---------------

Crystal

- Crystal (001)
- Crystal F (001)

Colors

Plain Colors

- Amethyst F (204)
- Aquamarine F (202)
- Black Diamond F (215)
- Blush Rose F (257)
- Denim Blue F (266)
- Emerald F (205)
- Fern Green F (291)
- Graphite F (253)
- Greige F (284)
- Iris F (219)
- Jet (280)
- Light Colorado Topaz F (246)
- Light Rose F (223)
- Light Silk F (261)
- Light Turquoise F (263)
- Majestic Blue F (296)
- Montana F (207)
- Olivine F (228)
- Padparadscha F (542)
- Provence Lavender F (283)
- Rose F (209)
- Rose Peach F (262)
- Scarlet F (276)
- Siam F (208)
- Smoky Mauve F (265)
- Tangerine F (259)
- Tanzanite F (539)
- Vintage Rose F (319)

Opal Colors

- Chrysolite Opal F (294)

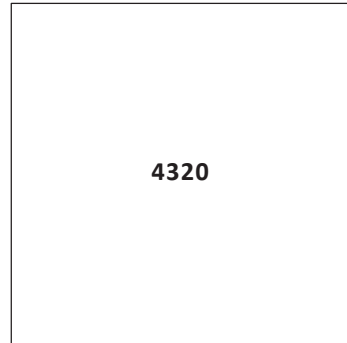

Size	MM 4,0X 2,9	MM 6,0X 4,0	MM 8,0X 6,0	MM 10,0X 7,0	MM 14,0X 10,0	MM 18,0X 13,0
------	-------------	-------------	-------------	--------------	---------------	---------------

- Pacific Opal F (390)
- Rose Water Opal F (395)
- White Opal F (234)
- Yellow Opal F (231)

Crystal Effects

Transparent Effects

- Crystal Antique Pink F (001 ANTP)
- Crystal AB F (001 AB)
- Crystal Blue Shade F (001 BLSH)
- Crystal Golden Shadow F (001 GSHA)
- Crystal Ignite (001 IGNIT)
- Crystal Luminous Green F (001 LUMG)
- Crystal Moonlight F (001 MOL)
- Crystal Paradise Shine F (001 PARSH)
- Crystal Silver Night F (001 SINI)
- Crystal Silver Shade F (001 SSHA)

Metallic Effects

- Crystal Metallic Light Gold F (001 MLGLD)
- Crystal Metallic Sunshine F (001 METSH)
- Crystal Rainbow Dark F (001 RABDK)
- Crystal Rose Gold F (001 ROGL)
- Crystal Scarabaeus Green F (001 SCGR)

Crystal Patina

- Crystal Black Patina F (001 BLAPA)
- Crystal Gold Patina F (001 GOLPA)
- Crystal Rose Patina F (001 ROSPA)
- Crystal Silver Patina F (001 SILPA)
- Crystal White Patina F (001 WHIPA)

Crystal Lacquer ^{Pro}</p>
</div>
<div data-bbox=

4320		Siz					
		MM 4,0X 2,9	MM 6,0X 4,0	MM 8,0X 6,0	MM 10,0X 7,0	MM 14,0X 10,0	MM 18,0X 13,0
	Crystal Dark Red (001 L108S)					■	■
	Crystal Ivory Cream (001 L106S)					■	■
	Crystal Laguna DeLite (001 L142D)					■	■
	Crystal Lavender DeLite (001 L144D)					■	■
	Crystal Light Coral (001 L116S)					■	■
	Crystal Light Grey DeLite (001 L129D)					■	■
	Crystal Lilac (001 L126S)					■	■
	Crystal Lime (001 L125S)					■	■
	Crystal Lotus Pink DeLite (001 L145D)					■	■
	Crystal Mint Green (001 L115S)					■	■
	Crystal Ocean DeLite (001 L143D)					■	■
	Crystal Ochre DeLite (001 L131D)					■	■
	Crystal Orange Glow DeLite (001 L146D)					■	■
	Crystal Peach DeLite (001 L140D)					■	■
	Crystal Peony Pink (001 L113S)					■	■
	Crystal Royal Blue (001 L110S)					■	■
	Crystal Royal Blue DeLite (001 L110D)					■	■
	Crystal Royal Green (001 L109S)					■	■
	Crystal Royal Red (001 L107S)					■	■
	Crystal Royal Red DeLite (001 L107D)					■	■
	Crystal Silky Sage DeLite (001 L147D)					■	■
	Crystal Summer Blue (001 L114S)					■	■
	Crystal Sunshine DeLite (001 L141D)					■	■
Color Effects							
	Amethyst Ignite (204 IGNIT)	■	■	■	■	■	■
	Aquamarine Ignite (202 IGNIT)	■	■	■	■	■	■
	Emerald Ignite (205 IGNIT)	■	■	■	■	■	■
	Light Colorado Topaz Ignite (246 IGNIT)	■	■	■	■	■	■
	Light Rose Ignite (223 IGNIT)	■	■	■	■	■	■
	Scarlet Ignite (276 IGNIT)	■	■	■	■	■	■

4322 Teardrop FancyStone

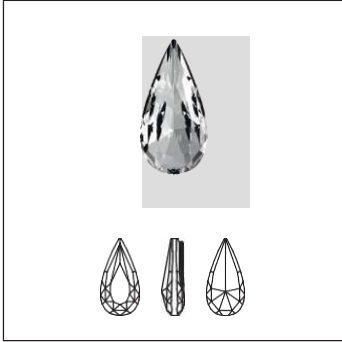

Siz	MM 10,0X 5,0	MM 14,0X 7,0	MM 18,0X 9,0	MM 22,0X 11,0	MM 30,0X 15,0
-----	--------------	--------------	--------------	---------------	---------------

Crystal

Crystal F (001)	■	■	■	■	■
-----------------	---	---	---	---	---

Colors

Plain Colors

Amethyst F (204)	■	■	■	■	■
Aquamarine F (202)	■	■	■	■	■
Black Diamond F (215)	■	■	■	■	■
Denim Blue F (266)	■	■	■	■	■
Emerald F (205)	■	■	■	■	■
Jet (280)	■	■	■	■	■
Light Colorado Topaz F (246)	■	■	■	■	■
Majestic Blue F (296)	■	■	■	■	■
Montana F (207)	■	■	■	■	■
Scarlet F (276)	■	■	■	■	■
Tanzanite F (539)	■	■	■	■	■
Vintage Rose F (319)	■	■	■	■	■

Crystal Effects

Transparent Effects

Crystal Antique Pink F (001 ANTP)	■	■	■	■	■
Crystal AB F (001 AB)	■	■	■	■	■
Crystal Golden Shadow F (001 GSHA)	■	■	■	■	■
Crystal Silver Night (001 SINI)	■	■	■	■	■
Crystal Silver Shade F (001 SSHA)	■	■	■	■	■

4327 Large Pear Fancy Stone



Siz
MM 30,0X 20,0
MM 40,0X 27,0

Crystal

Crystal F (001)

Colors

Plain Colors

- Amethyst F (204)
- Aquamarine F (202)
- Black Diamond F (215)
- Blush Rose F (257)
- Chrysolite F (238)
- Fuchsia F (502)
- Graphite F (253)
- Jet (280)
- Light Colorado Topaz F (246)
- Light Rose F (223)
- Majestic Blue F (296)
- Montana F (207)
- Tanzanite F (539)

Opal Colors

White Opal F (234)

Crystal Effects

Transparent Effects

- Crystal Antique Pink F (001 ANTP)
- Crystal Astral Pink F (001 API)
- Crystal AB F (001 AB)
- Crystal Golden Shadow F (001 GSHA)
- Crystal Luminous Green F (001 LUMG)
- Crystal Red Magma F (001 REDM)
- Crystal Silver Shade F (001 SSHA)
- Crystal Vitrail Medium (001 VM)

Metallic Effects

Crystal Rainbow Dark F (001 RABDK)

Crystal Lacquer ^{Pro}

- Crystal Army Green DeLite (001 L130D)
- Crystal Azure Blue (001 L112S)
- Crystal Burgundy DeLite (001 L132D)

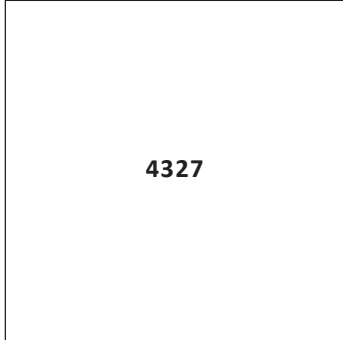

Siz
MM 30,0X 20,0
MM 40,0X 27,0

- Crystal Buttercup (001 L124S)
- Crystal Cappuccino DeLite (001 L133D)
- Crystal Dark Grey (001 L111S)
- Crystal Dark Red (001 L108S)
- Crystal Ivory Cream (001 L106S)
- Crystal Laguna DeLite (001 L142D)
- Crystal Lavender DeLite (001 L144D)
- Crystal Light Coral (001 L116S)
- Crystal Light Grey DeLite (001 L129D)
- Crystal Lilac (001 L126S)
- Crystal Lime (001 L125S)
- Crystal Lotus Pink DeLite (001 L145D)
- Crystal Mint Green (001 L115S)
- Crystal Ocean DeLite (001 L143D)
- Crystal Ochre DeLite (001 L131D)
- Crystal Orange Glow DeLite (001 L146D)
- Crystal Peach DeLite (001 L140D)
- Crystal Peony Pink (001 L113S)
- Crystal Royal Blue (001 L110S)
- Crystal Royal Blue DeLite (001 L110D)
- Crystal Royal Green (001 L109S)
- Crystal Royal Red (001 L107S)
- Crystal Royal Red DeLite (001 L107D)
- Crystal Silky Sage DeLite (001 L147D)
- Crystal Summer Blue (001 L114S)
- Crystal Sunshine DeLite (001 L141D)

4328 XILION PearFancyStone



Siz	MM 6,0X 3,6	MM 8,0X 4,8	MM 10,0X 6,0	MM 13,0X 7,8
-----	-------------	-------------	--------------	--------------

Crystal

Crystal F (001)	■	■	■	■
-----------------	---	---	---	---

Colors

Plain Colors

Amethyst F (204)	■	■	■	■
Aquamarine F (202)	■	■	■	■
Black Diamond F (215)	■	■	■	■
Emerald F (205)	■	■	■	■
Jet (280)	■	■	■	■
Light Amethyst F (212)	■	■	■	■
Light Colorado Topaz F (246)	■	■	■	■
Light Rose F (223)	■	■	■	■
Majestic Blue F (296)	■	■	■	■
Montana F (207)	■	■	■	■
Rose F (209)	■	■	■	■
Scarlet F (276)	■	■	■	■
Siam F (208)	■	■	■	■
Tanzanite F (539)	■	■	■	■

Crystal Effects

Transparent Effects

Crystal Golden Shadow F (001_GSHA)	■	■	■	■
------------------------------------	---	---	---	---

4331 Raindrop Fancy Stone



Siz	MM 11,0	MM 15,0	MM 20,0	MM 30,0
-----	---------	---------	---------	---------

Crystal

<input type="checkbox"/> Crystal F (001)	<input checked="" type="checkbox"/>	<input checked="" type="checkbox"/>	<input checked="" type="checkbox"/>	<input checked="" type="checkbox"/>
--	-------------------------------------	-------------------------------------	-------------------------------------	-------------------------------------

Colors

Plain Colors

<input type="checkbox"/> Denim Blue F (266)	<input checked="" type="checkbox"/>	<input checked="" type="checkbox"/>	<input checked="" type="checkbox"/>	<input type="checkbox"/>
<input type="checkbox"/> Tanzanite F (539)	<input checked="" type="checkbox"/>	<input checked="" type="checkbox"/>	<input checked="" type="checkbox"/>	<input type="checkbox"/>

Crystal Effects

Transparent Effects

<input type="checkbox"/> Crystal Antique Pink F (001 ANTP)	<input checked="" type="checkbox"/>	<input checked="" type="checkbox"/>	<input checked="" type="checkbox"/>	<input checked="" type="checkbox"/>
<input type="checkbox"/> Crystal AB F (001 AB)	<input checked="" type="checkbox"/>	<input checked="" type="checkbox"/>	<input checked="" type="checkbox"/>	<input checked="" type="checkbox"/>
<input type="checkbox"/> Crystal Silver Night (001 SINI)	<input checked="" type="checkbox"/>	<input checked="" type="checkbox"/>	<input checked="" type="checkbox"/>	<input checked="" type="checkbox"/>
<input type="checkbox"/> Crystal Silver Shade F (001 SSHA)	<input checked="" type="checkbox"/>	<input checked="" type="checkbox"/>	<input checked="" type="checkbox"/>	<input checked="" type="checkbox"/>

4370

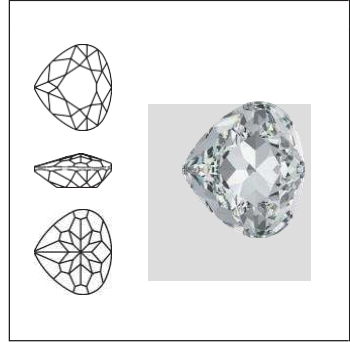

Crystal

Crystal F (001)

Size

MM 11,0X 10,0

MM 15,5X 14,0

MM 20,0X 18,0

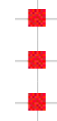

4418 XILION PointedSquare FancyStone

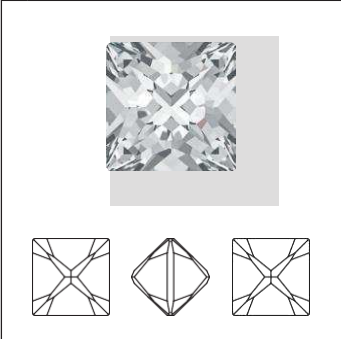
	Siz MM 6,0 MM 8,0		
Crystal			
<input type="checkbox"/>	Crystal F (001)	<input checked="" type="checkbox"/>	<input checked="" type="checkbox"/>
Colors			
Plain Colors			
<input type="checkbox"/>	Black Diamond F (215)	<input checked="" type="checkbox"/>	
<input type="checkbox"/>	Montana F (207)	<input checked="" type="checkbox"/>	
Crystal Effects			
Transparent Effects			
<input type="checkbox"/>	Crystal AB F (001 AB)	<input checked="" type="checkbox"/>	
Crystal Patina			
<input type="checkbox"/>	Crystal Gold Patina F (001 GOLPA)	<input checked="" type="checkbox"/>	<input checked="" type="checkbox"/>
<input type="checkbox"/>	Crystal White Patina F (001 WHIPA)	<input checked="" type="checkbox"/>	<input checked="" type="checkbox"/>

4428 XILION Square FancyStone

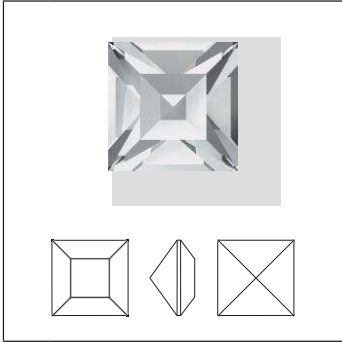

Size 1.5, 2mm

4428 XILION Square FancyStone

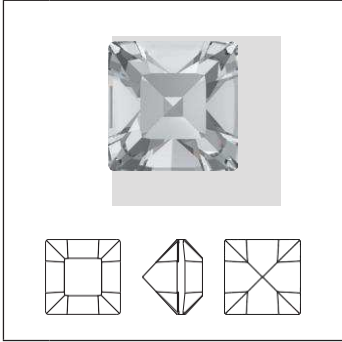

Size 3, 4 mm

4428 XILION Square FancyStone

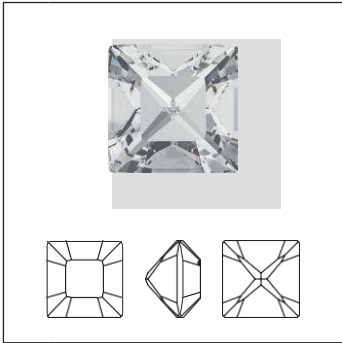

Size 5, 6, 8 mm

CORE ASSORTMENT

4428		Size						
		MM 1,5	MM 2,0	MM 3,0	MM 4,0	MM 5,0	MM 6,0	MM 8,0
Crystal								
Crystal F (001)		■	■	■	■	■	■	■
Colors								
Plain Colors								
Amethyst F (204)		■	■	■	■	■	■	■
Aquamarine F (202)		■	■	■	■	■	■	■
Black Diamond F (215)		■	■	■	■	■	■	■
Denim Blue F (266)		■	■	■	■	■	■	■
Emerald F (205)		■	■	■	■	■	■	■
Fuchsia F (502)		■	■	■	■	■	■	■
Graphite F (253)		■	■	■	■	■	■	■
Greige F (284)		■	■	■	■	■	■	■
Indicolite F (379)		■	■	■	■	■	■	■
Iris F (219)		■	■	■	■	■	■	■
Jet (280)		■	■	■	■	■	■	■
Light Amethyst F (212)		■	■	■	■	■	■	■
Light Colorado Topaz F (246)		■	■	■	■	■	■	■
Light Peach F (362)		■	■	■	■	■	■	■
Light Rose F (223)		■	■	■	■	■	■	■
Light Sapphire F (211)		■	■	■	■	■	■	■
Light Siam F (227)		■	■	■	■	■	■	■
Light Smoked Topaz F (221)		■	■	■	■	■	■	■
Majestic Blue F (296)		■	■	■	■	■	■	■
Montana F (207)		■	■	■	■	■	■	■
Peridot F (214)		■	■	■	■	■	■	■
Rose F (209)		■	■	■	■	■	■	■
Sapphire F (206)		■	■	■	■	■	■	■
Scarlet F (276)		■	■	■	■	■	■	■
Siam F (208)		■	■	■	■	■	■	■
Smoked Topaz F (220)		■	■	■	■	■	■	■
Tangerine F (259)		■	■	■	■	■	■	■
Tanzanite F (539)		■	■	■	■	■	■	■
Violet F (371)		■	■	■	■	■	■	■
Opal Colors								
White Opal F (234)		■	■	■	■	■	■	■

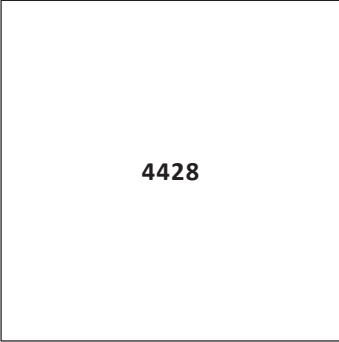

4428

Siz

MM 1,5
MM 2,0
MM 3,0
MM 4,0
MM 5,0
MM 6,0
MM 8,0

Crystal Effects

Transparent Effects

Crystal Antique Pink F (001 ANTP)	■	■	■	■		
Crystal AB F (001 AB)	■	■	■	■	■	■
Crystal Blue Shade F (001 BLSH)	■	■	■	■		
Crystal Golden Shadow F (001 GSHA)	■	■	■	■	■	■
Crystal Paradise Shine F (001 PARSH)		■	■	■	■	■
Crystal Silver Night F (001 SINI)	■	■	■	■		■
Crystal Silver Shade F (001 SSHA)	■	■	■	■	■	■
Metallic Effects						
Crystal Metallic Light Gold F (001 MLGLD)	■	■	■	■		
Crystal Metallic Sunshine F (001 METSH)		■	■	■	■	■
Crystal Rose Gold F (001 ROGL)	■	■	■	■		
Color Effects						
Jet Hematite (280 HEM)	■	■	■	■		

4439 Square Ring Fancy Stone

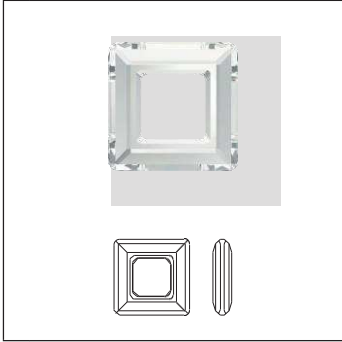

Siz	MM 14,0	MM 20,0	MM 30,0

- Crystal Effects**
- Transparent Effects**
- Crystal AB (001 AB) ■ ■
- Crystal Bermuda Blue (001 BB) ■ ■
- Crystal Vitrail Light (001 VL) ■ ■
- Crystal Volcano (001 VOL) ■ ■
- Metallic Effects**
- Crystal CAL V SI (001 CAVSI) ■ ■ ■

4447 Princess Square Fancy Stone

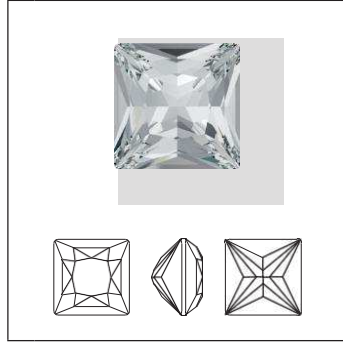

Siz	MM 6,0	MM 8,0	MM 10,0	MM 12,0

- Crystal**
- Crystal F (001) ■ ■ ■ ■
- Colors**
- Plain Colors**
- Aquamarine F (202) ■
- Tanzanite F (539) ■
- Crystal Effects**
- Transparent Effects**
- Crystal AB F (001 AB) ■
- Crystal Golden Shadow F (001 GSHA) ■ ■ ■ ■
- Crystal Silver Shade F (001 SSHA) ■ ■ ■ ■

4460 MYSTIC SQUARE FS



Siz	MM 8,0	MM 10,0	MM 14,0	MM 18,0
-----	--------	---------	---------	---------

Crystal

Crystal F (001)	■	■	■	■
-----------------	---	---	---	---

Colors

Plain Colors

Amethyst F (204)	■	■	■	■
Aquamarine F (202)	■	■	■	■
Emerald F (205)	■	■	■	■
Iris F (219)	■	■	■	■
Light Colorado Topaz F (246)	■	■	■	■
Scarlet F (276)	■	■	■	■

Crystal Effects

Transparent Effects

Crystal Astral Pink F (001 API)	■	■	■	■
Crystal AB F (001 AB)	■	■	■	■
Crystal Luminous Green F (001 LUMG)	■	■	■	■
Crystal Paradise Shine F (001 PARSH)	■	■	■	■
Crystal Vitrail Medium F (001 VM)	■	■	■	■

Color Effects

Light Topaz Shimmer F (226 SHIM)	■	■	■	■
----------------------------------	---	---	---	---

4461 Classical Square Fancy Stone



Siz

MM 8,0	MM 12,0	MM 16,0
--------	---------	---------

Crystal

Crystal F (001)

Crystal Effects

Transparent Effects

Crystal Golden Shadow F (001 GSHA)

Crystal Silver Shade F (001 SSHA)

■	■	■
■	■	■
■	■	■

CORE ASSORTMENT

4470 Cushion Square Fancy Stone

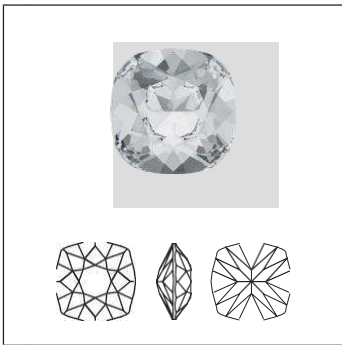

Siz	MM 8,0	MM 10,0	MM 12,0	MM 18,0
-----	--------	---------	---------	---------

Crystal

Crystal (001)		■	■	■
Crystal F (001)	■	■	■	■

Colors

Plain Colors

Amethyst F (204)		■	■	
Aquamarine F (202)	■	■	■	
Black Diamond F (215)	■	■	■	
Blush Rose F (257)		■	■	
Burgundy F (515)		■	■	
Chrysolite F (238)	■	■	■	
Denim Blue F (266)	■	■	■	
Emerald F (205)		■	■	
Erinite F (360)	■	■	■	
Fern Green F (291)		■	■	
Graphite F (253)		■	■	
Greige F (284)		■	■	
Indicolite F (379)	■	■	■	
Iris F (219)		■	■	
Jet (280)	■	■	■	
Light Azore F (361)	■	■	■	
Light Colorado Topaz F (246)		■	■	
Light Peach F (362)		■	■	
Light Rose F (223)		■	■	
Light Sapphire F (211)		■	■	
Light Siam F (227)		■	■	
Light Silk F (261)		■	■	
Light Topaz F (226)		■	■	
Light Turquoise F (263)	■	■	■	
Majestic Blue F (296)		■	■	
Padparadscha F (542)		■	■	
Provence Lavender F (283)		■	■	
Rose Peach F (262)		■	■	
Scarlet F (276)		■	■	
Siam F (208)		■	■	

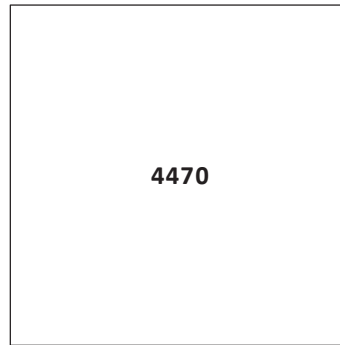

Siz	MM 8,0	MM 10,0	MM 12,0	MM 18,0
-----	--------	---------	---------	---------

Smoky Mauve F (265)		■	■	
Smoky Quartz F (225)		■	■	
Tanzanite F (539)	■	■	■	
Vintage Rose F (319)	■	■	■	
Violet F (371)	■	■	■	
Opal Colors				
Air Blue Opal F (285)		■	■	
Chrysolite Opal F (294)		■	■	
Pacific Opal F (390)	■	■	■	
Rose Water Opal F (395)	■	■	■	
White Opal F (234)	■	■	■	
Yellow Opal F (231)		■	■	
Crystal Effects				
Transparent Effects				
Crystal Antique Pink F (001 ANTP)	■	■	■	
Crystal Astral Pink F (001 API)		■	■	
Crystal AB F (001 AB)		■	■	
Crystal Bermuda Blue F (001 BB)		■	■	
Crystal Blue Shade F (001 BLSH)		■	■	
Crystal Golden Shadow F (001 GSHA)	■	■	■	
Crystal Ignite (001 IGNIT)	■	■	■	■
Crystal Luminous Green F (001 LUMG)		■	■	
Crystal Moonlight F (001 MOL)		■	■	
Crystal Paradise Shine F (001 PARSH)		■	■	
Crystal Silver Night (001 SINI)	■			
Crystal Silver Night F (001 SINI)		■	■	
Crystal Silver Shade (001 SSHA)		■	■	
Crystal Silver Shade F (001 SSHA)	■	■	■	
Metallic Effects				
Crystal Light Chrome F (001 LTCH)		■	■	
Crystal Metallic Sunshine F (001 METSH)		■	■	
Crystal Rainbow Dark F (001 RABDK)		■	■	
Crystal Rose Gold F (001 ROGL)		■	■	
Crystal Scarabaeus Green F (001 SCGR)		■	■	
Crystal Patina				

*** designed by Jean Paul Gaultier

◆ Core Assortment

4470		Siz			
		MM 8,0	MM 10,0	MM 12,0	MM 18,0
	Crystal Black Patina F (001 BLAPA)		■	■	
	Crystal Gold Patina F (001 GOLPA)		■	■	
	Crystal Rose Patina F (001 ROSPA)		■	■	
	Crystal Silver Patina F (001 SILPA)		■	■	
	Crystal White Patina F (001 WHIPA)		■	■	
Crystal Lacquer <sup>Pro</sup>					
	Crystal Army Green DeLite (001 L130D)		■	■	
	Crystal Azure Blue (001 L112S)		■	■	
	Crystal Burgundy DeLite (001 L132D)		■	■	
	Crystal Buttercup (001 L124S)		■	■	
	Crystal Cappuccino DeLite (001 L133D)		■	■	
	Crystal Dark Grey (001 L111S)		■	■	
	Crystal Dark Red (001 L108S)		■	■	
	Crystal Ivory Cream (001 L106S)		■	■	
	Crystal Laguna DeLite (001 L142D)		■	■	
	Crystal Lavender DeLite (001 L144D)		■	■	
	Crystal Light Coral (001 L116S)		■	■	
	Crystal Light Grey DeLite (001 L129D)		■	■	
	Crystal Lilac (001 L126S)		■	■	
	Crystal Lime (001 L125S)		■	■	
	Crystal Lotus Pink DeLite (001 L145D)		■	■	
	Crystal Mint Green (001 L115S)		■	■	
	Crystal Ocean DeLite (001 L143D)		■	■	
	Crystal Ochre DeLite (001 L131D)		■	■	
	Crystal Orange Glow DeLite (001 L146D)		■	■	
	Crystal Peach DeLite (001 L140D)		■	■	
	Crystal Peony Pink (001 L113S)		■	■	
	Crystal Powder Blue (001 L104)		■	■	
	Crystal Powder Green (001 L102)		■	■	
	Crystal Powder Grey (001 L105)		■	■	
	Crystal Powder Rose (001 L103)		■	■	
	Crystal Powder Yellow (001 L101)		■	■	
	Crystal Royal Blue (001 L110S)		■	■	
	Crystal Royal Blue DeLite (001 L110D)		■	■	
	Crystal Royal Green (001 L109S)		■	■	

4470		Siz			
		MM 8,0	MM 10,0	MM 12,0	MM 18,0
	Crystal Royal Red (001 L107S)		■	■	
	Crystal Royal Red DeLite (001 L107D)		■	■	
	Crystal Silky Sage DeLite (001 L147D)		■	■	
	Crystal Summer Blue (001 L114S)		■	■	
	Crystal Sunshine DeLite (001 L141D)		■	■	
Color Effects					
	Amethyst Ignite (204 IGNIT)		■	■	
	Aquamarine Ignite (202 IGNIT)		■	■	■
	Black Diamond Shimmer F (215 SHIM)		■	■	
	Emerald Ignite (205 IGNIT)		■	■	
	Erinite Shimmer F (360 SHIM)		■	■	
	Light Colorado Topaz Ignite (246 IGNIT)		■	■	
	Light Colorado Topaz Shimmer F (246 SHIM)		■	■	
	Light Rose Ignite (223 IGNIT)		■	■	■
	Light Rose Shimmer F (223 SHIM)		■	■	
	Light Sapphire Shimmer F (211 SHIM)		■	■	
	Light Siam Shimmer F (227 SHIM)		■	■	
	Light Topaz Shimmer F (226 SHIM)		■	■	
	Scarlet Ignite (276 IGNIT)		■	■	

4480 Imperial Fancy Stone

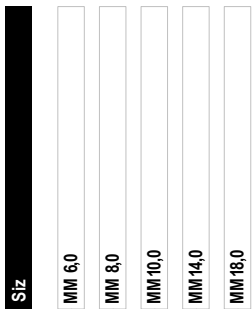
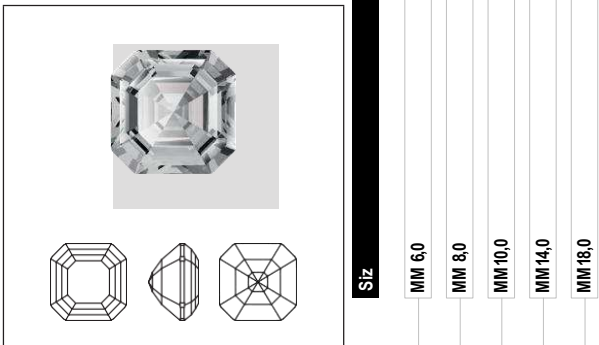

Crystal

Crystal F (001)

Colors

Plain Colors

- Amethyst F (204)
- Aquamarine F (202)
- Emerald F (205)
- Iris F (219)
- Jet (280)
- Light Colorado Topaz F (246)
- Light Rose F (223)
- Majestic Blue F (296)
- Montana F (207)
- Scarlet F (276)

Crystal Effects

Transparent Effects

- Crystal AB F (001 AB)
- Crystal Golden Shadow F (001 GSHA)
- Crystal Ignite (001 IGNIT)
- Crystal Silver Night (001 SINI)
- Crystal Silver Shade F (001 SSHA)

Metallic Effects

Crystal Metallic Light Gold F (001 MLGLD)

Crystal Lacquer ^{Pro}

- Crystal Army Green DeLite (001 L130D)
- Crystal Burgundy DeLite (001 L132D)
- Crystal Cappuccino DeLite (001 L133D)
- Crystal Light Grey DeLite (001 L129D)
- Crystal Ochre DeLite (001 L131D)

Color Effects

- Amethyst Ignite (204 IGNIT)
- Aquamarine Ignite (202 IGNIT)
- Emerald Ignite (205 IGNIT)
- Light Colorado Topaz Ignite (246 IGNIT)
- Light Rose Ignite (223 IGNIT)

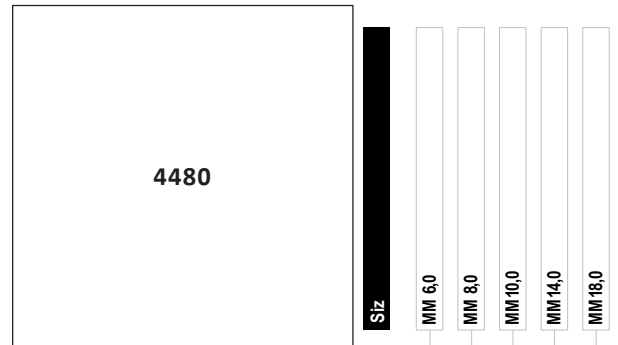

Scarlet Ignite (276 IGNIT)

Jet Hematite (280 HEM)

4483 FANTASY CUSHION FS



Siz	MM 8,0	MM 10,0	MM 12,0	MM 14,0
-----	--------	---------	---------	---------

Crystal

Crystal F (001)	■	■	■	■
-----------------	---	---	---	---

Colors

Plain Colors

Amethyst F (204)	■	■	■	■
Aquamarine F (202)	■	■	■	■
Emerald F (205)	■	■	■	■
Iris F (219)		■	■	
Jet (280)	■	■	■	■
Light Colorado Topaz F (246)	■	■	■	■
Majestic Blue F (296)	■	■	■	■
Scarlet F (276)	■	■	■	■
Tanzanite F (539)	■	■	■	■
Vintage Rose F (319)	■	■	■	■

Opal Colors

White Opal F (234)	■	■	■	■
--------------------	---	---	---	---

Crystal Effects

Transparent Effects

Crystal Golden Shadow F (001_GSHA)	■	■	■	■
Crystal Silver Night (001_SINI)	■	■	■	■

Metallic Effects

Crystal Metallic Light Gold F (001_MLGLD)	■	■	■	■
---	---	---	---	---

4485 Twister Fancy Stone

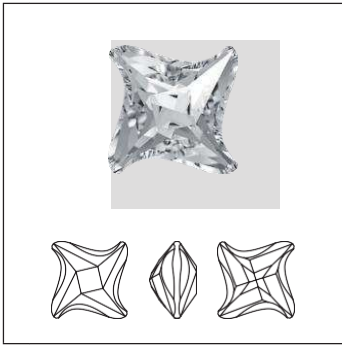

Siz	MM 6,0	MM 10,5	MM 17,0
-----	--------	---------	---------

Crystal

Crystal F (001)	■	■	■
-----------------	---	---	---

Colors

Plain Colors

Aquamarine F (202)	■	■	■
--------------------	---	---	---

Graphite F (253)	■	■	■
------------------	---	---	---

Tanzanite F (539)	■	■	■
-------------------	---	---	---

Crystal Effects

Transparent Effects

Crystal Antique Pink F (001 ANTP)	■	■	■
-----------------------------------	---	---	---

Crystal AB F (001 AB)	■	■	■
-----------------------	---	---	---

Crystal Blue Shade F (001 BLSH)	■	■	■
---------------------------------	---	---	---

Crystal Golden Shadow F (001 GSHA)	■	■	■
------------------------------------	---	---	---

Crystal Luminous Green F (001 LUMG)	■	■	■
-------------------------------------	---	---	---

Crystal Silver Night (001 SINI)	■	■	■
---------------------------------	---	---	---

Crystal Silver Shade F (001 SSHA)	■	■	■
-----------------------------------	---	---	---

4499

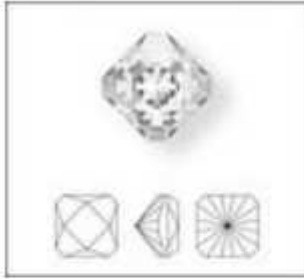

Size
MM 6,0
MM 10,0
MM 14,0
MM 20,0

Crystal

Crystal F (001)

Farben

Plain Colors

Amethyst F (204)

Aquamarine F (202)

Emerald F (205)

Jet (280)

Majestic Blue F (296)

Rose F (209)

Scarlet F (276)

Crystal Effects

Transparente Effekte

Crystal AB F (001 AB)

Crystal Golden Shadow F (001 GSHA)

Crystal Silver Night (001 SINI)

Crystal Vitrail Medium F (001 VM)

Crystal Lacquer ^{Pro}

Crystal Laguna DeLite (001 L142D)

Crystal Lavender DeLite (001 L144D)

Crystal Lotus Pink DeLite (001 L145D)

Crystal Ocean DeLite (001 L143D)

Crystal Orange Glow DeLite (001 L146D)

Crystal Peach DeLite (001 L140D)

Crystal Royal Blue DeLite (001 L110D)

Crystal Royal Red DeLite (001 L107D)

Crystal Silky Sage DeLite (001 L147D)

Crystal Sunshine DeLite (001 L141D)

Crystal F (001)	MM 6,0	MM 10,0	MM 14,0	MM 20,0
Amethyst F (204)	MM 6,0	MM 10,0	MM 14,0	MM 20,0
Aquamarine F (202)	MM 6,0	MM 10,0	MM 14,0	MM 20,0
Emerald F (205)	MM 6,0	MM 10,0	MM 14,0	MM 20,0
Jet (280)	MM 6,0	MM 10,0	MM 14,0	MM 20,0
Majestic Blue F (296)	MM 6,0	MM 10,0	MM 14,0	MM 20,0
Rose F (209)	MM 6,0	MM 10,0	MM 14,0	MM 20,0
Scarlet F (276)	MM 6,0	MM 10,0	MM 14,0	MM 20,0
Crystal AB F (001 AB)	MM 6,0	MM 10,0	MM 14,0	MM 20,0
Crystal Golden Shadow F (001 GSHA)	MM 6,0	MM 10,0	MM 14,0	MM 20,0
Crystal Silver Night (001 SINI)	MM 6,0	MM 10,0	MM 14,0	MM 20,0
Crystal Vitrail Medium F (001 VM)	MM 6,0	MM 10,0	MM 14,0	MM 20,0
Crystal Laguna DeLite (001 L142D)	MM 6,0	MM 10,0	MM 14,0	MM 20,0
Crystal Lavender DeLite (001 L144D)	MM 6,0	MM 10,0	MM 14,0	MM 20,0
Crystal Lotus Pink DeLite (001 L145D)	MM 6,0	MM 10,0	MM 14,0	MM 20,0
Crystal Ocean DeLite (001 L143D)	MM 6,0	MM 10,0	MM 14,0	MM 20,0
Crystal Orange Glow DeLite (001 L146D)	MM 6,0	MM 10,0	MM 14,0	MM 20,0
Crystal Peach DeLite (001 L140D)	MM 6,0	MM 10,0	MM 14,0	MM 20,0
Crystal Royal Blue DeLite (001 L110D)	MM 6,0	MM 10,0	MM 14,0	MM 20,0
Crystal Royal Red DeLite (001 L107D)	MM 6,0	MM 10,0	MM 14,0	MM 20,0
Crystal Silky Sage DeLite (001 L147D)	MM 6,0	MM 10,0	MM 14,0	MM 20,0
Crystal Sunshine DeLite (001 L141D)	MM 6,0	MM 10,0	MM 14,0	MM 20,0

4500

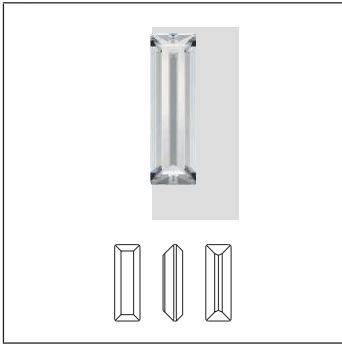

Siz	MM 3,0X 2,0	MM 6,0X 2,0	MM 10,0X 3,0
Crystal F (001)	Black	Black	Orange
Amethyst F (204)		Orange	
Aquamarine F (202)		Orange	
Black Diamond F (215)		Orange	
Jet (280)		Orange	
Jonquil F (213)		Orange	
Light Rose F (223)		Orange	
Light Smoked Topaz F (221)		Red	

Crystal

Crystal F (001)

Colors

Plain Colors

Amethyst F (204)

Aquamarine F (202)

Black Diamond F (215)

Jet (280)

Jonquil F (213)

Light Rose F (223)

Light Smoked Topaz F (221)

CORE ASSORTMENT

4501

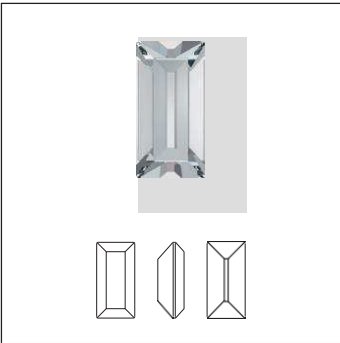

Siz	MM 4,0X 2,0	MM 5,0X 2,0	MM 5,0X 2,5	MM 7,0X 3,0	MM 10,0X 5,0
-----	-------------	-------------	-------------	-------------	--------------

Crystal

Crystal F (001)	■	■	■	■	■
-----------------	---	---	---	---	---

Colors

Plain Colors

Amethyst F (204)	■	■	■	■	■
Aquamarine F (202)	■	■	■	■	■
Black Diamond F (215)	■	■	■	■	■
Emerald F (205)	■	■	■	■	■
Erinite F (360)	■	■	■	■	■
Fuchsia F (502)	■	■	■	■	■
Jet (280)	■	■	■	■	■
Light Amethyst F (212)	■	■	■	■	■
Light Colorado Topaz F (246)	■	■	■	■	■
Light Peach F (362)	■	■	■	■	■
Light Rose F (223)	■	■	■	■	■
Light Sapphire F (211)	■	■	■	■	■
Light Smoked Topaz F (221)	■	■	■	■	■
Montana F (207)	■	■	■	■	■
Peridot F (214)	■	■	■	■	■
Rose F (209)	■	■	■	■	■
Sapphire F (206)	■	■	■	■	■
Scarlet F (276)	■	■	■	■	■
Siam F (208)	■	■	■	■	■
Smoked Topaz F (220)	■	■	■	■	■
Tanzanite F (539)	■	■	■	■	■
Topaz F (203)	■	■	■	■	■
Violet F (371)	■	■	■	■	■

Crystal Effects

Transparent Effects

Crystal AB F (001 AB)	■	■	■	■	■
Crystal Golden Shadow F (001 GSHA)	■	■	■	■	■
Crystal Silver Night F (001 SINI)	■	■	■	■	■
Crystal Silver Shade F (001 SSHA)	■	■	■	■	■

4502

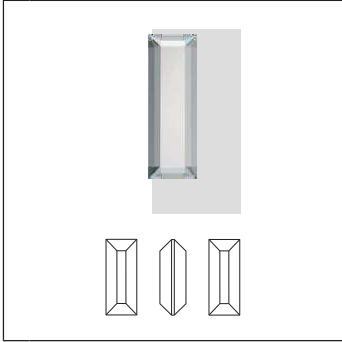

Siz

MM 3,0X 1,0

Crystal

Crystal F (001)

4503 Tapered Baguette Fancy Stone

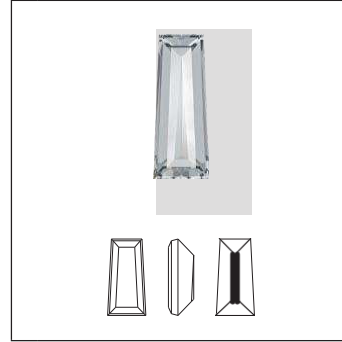

Siz

MM 4,0X 2,0

MM 6,3X 2,4

Crystal

Crystal F (001)

4524 Pure Baguette Fancy Stone

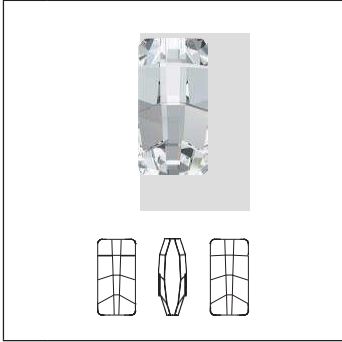

Size 12x6 mm

4524 Pure Baguette Fancy Stone

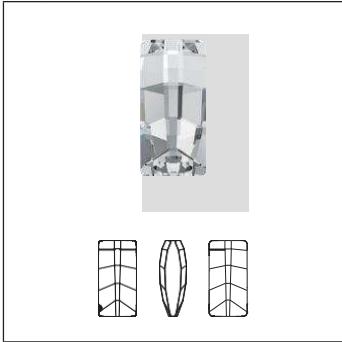

Size 16x8, 23x11 mm

4524	Size	MM 12,0X 6,0	MM 16,0X 8,0	MM 23,0X 11,0
Crystal				
<input type="checkbox"/> Crystal F (001)		<input checked="" type="checkbox"/>	<input checked="" type="checkbox"/>	<input checked="" type="checkbox"/>
Colors				
Plain Colors				
<input type="checkbox"/> Amethyst F (204)		<input checked="" type="checkbox"/>	<input checked="" type="checkbox"/>	<input checked="" type="checkbox"/>
<input type="checkbox"/> Emerald F (205)		<input checked="" type="checkbox"/>	<input checked="" type="checkbox"/>	<input checked="" type="checkbox"/>
Crystal Effects				
Transparent Effects				
<input type="checkbox"/> Crystal AB F (001 AB)		<input checked="" type="checkbox"/>	<input checked="" type="checkbox"/>	<input type="checkbox"/>
<input type="checkbox"/> Crystal Golden Shadow F (001 GSHA)		<input checked="" type="checkbox"/>	<input checked="" type="checkbox"/>	<input type="checkbox"/>

4527 Step Out Fancy Stone

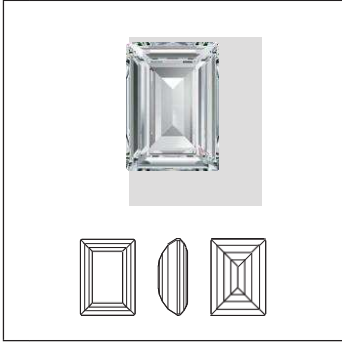

Siz	MM 8,0X 6,0	MM 14,0X 10,0	MM 18,0X 13,0
-----	-------------	---------------	---------------

Crystal

Crystal F (001)	■	■	■
-----------------	---	---	---

Colors

Plain Colors

Erinite F (360)	■	■	
Light Amethyst F (212)	■	■	
Montana F (207)	■	■	
Smoky Quartz F (225)	■	■	
Tanzanite F (539)	■	■	

Crystal Effects

Transparent Effects

Crystal Golden Shadow F (001 GSHA)	■	■	
Crystal Ignite (001 IGNIT)	■	■	■

4547 Princess Baguette Fancy Stone

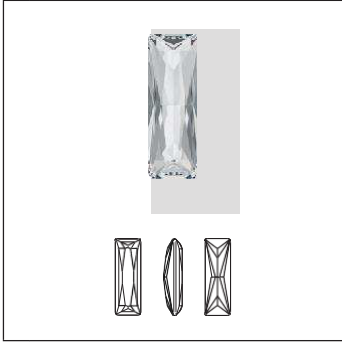

Size

MM 15,0X 5,0

MM 21,0X 7,0

Crystal

Crystal F (001)

4565 Classical Baguette Fancy Stone



Size
 MM 14,0X 10,0
 MM 18,0X 13,0

Crystal

Crystal F (001)

Colors

Plain Colors

Aquamarine F (202)

Tanzanite F (539)

Crystal Effects

Transparent Effects

Crystal Golden Shadow F (001 GSHA)

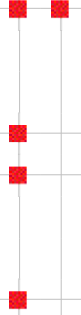

4568 Cushion Fancy Stone

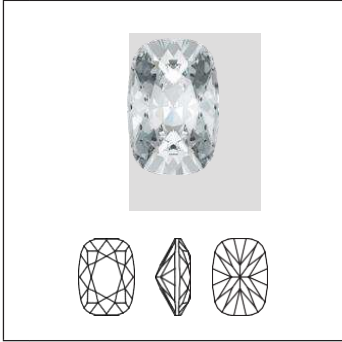

Siz	MM 8,0X 6,0	MM 14,0X 10,0	MM 18,0X 13,0	MM 27,0X 18,0
-----	-------------	---------------	---------------	---------------

Crystal

Crystal F (001)	Orange	Black	Black	Red
-----------------	--------	-------	-------	-----

Colors

Plain Colors

Aquamarine F (202)	Orange	Black	Black	
Denim Blue F (266)	Orange	Orange	Orange	
Jet (280)	Orange	Black	Black	
Light Colorado Topaz F (246)	Orange	Black	Black	
Light Siam F (227)	Orange	Black	Black	
Rose F (209)	Orange	Black	Black	
Tanzanite F (539)	Orange	Black	Black	

Crystal Effects

Transparent Effects

Crystal Antique Pink F (001 ANTP)	Orange	Orange	Orange	
Crystal Golden Shadow F (001 GSHA)	Orange	Black	Black	
Crystal Luminous Green F (001 LUMG)	Red	Red	Red	
Crystal Silver Night (001 SINI)	Orange	Black	Black	
Crystal Silver Shade F (001 SSHA)	Orange	Black	Black	

4595 ELONGATED IMPERIAL FS



Siz	MM 8,0X 4,0	MM 12,0X 6,0	MM 16,0X 8,0	MM 20,0X 10,0
-----	-------------	--------------	--------------	---------------

Crystal

Crystal F (001)	■	■	■	■
-----------------	---	---	---	---

Colors

Plain Colors

Amethyst F (204)	■	■	■	
Aquamarine F (202)	■	■	■	
Emerald F (205)	■	■	■	
Iris F (219)	■	■	■	
Jet (280)	■	■	■	■
Light Colorado Topaz F (246)	■	■	■	
Majestic Blue F (296)	■	■	■	
Scarlet F (276)	■	■	■	■

Crystal Effects

Transparent Effects

Crystal AB F (001 AB)	■	■	■	■
Crystal Golden Shadow F (001 GSHA)	■	■	■	■
Crystal Silver Night (001 SINI)	■	■	■	■
Crystal Silver Shade F (001 SSHA)	■	■	■	■

Metallic Effects

Crystal Metallic Light Gold F (001 MLGLD)	■	■	■	■
---	---	---	---	---

Color Effects

Jet Hematite (280 HEM)	■	■	■	
------------------------	---	---	---	--

4600

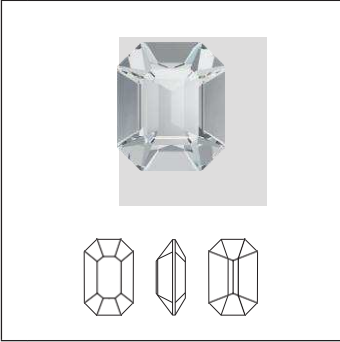

Siz	MM 6,0X 4,0	MM 8,0X 6,0	MM 10,0X 8,0	MM 12,0X 10,0
-----	-------------	-------------	--------------	---------------

Crystal

Crystal F (001)	Orange	Orange	Black	Red
-----------------	--------	--------	-------	-----

Colors

Plain Colors

Jet (280)	Orange	Orange	Black	Red
-----------	--------	--------	-------	-----

Montana F (207)	Orange	Orange	Black	Red
-----------------	--------	--------	-------	-----

Rose F (209)	Orange	Orange	Black	Red
--------------	--------	--------	-------	-----

Crystal Effects

Transparent Effects

Crystal Golden Shadow F (001 GSHA)	Orange	Orange	Black	Red
------------------------------------	--------	--------	-------	-----

Crystal Silver Shade F (001 SSHA)	Orange	Orange	Black	Red
-----------------------------------	--------	--------	-------	-----

4610 CurvedBackOctagonFancyStone



Siz	MM 14,0X 10,0	MM 18,0X 13,0	MM 20,0X 15,0
-----	---------------	---------------	---------------

Crystal

Crystal F (001)	■	■	■
-----------------	---	---	---

Colors

Plain Colors

Amethyst F (204)	■	■	■
Aquamarine F (202)	■	■	■
Black Diamond F (215)	■	■	■
Emerald F (205)	■	■	■
Jet (280)	■	■	■
Light Colorado Topaz F (246)	■	■	■
Montana F (207)	■	■	■
Peridot F (214)	■	■	■
Siam F (208)	■	■	■
Tanzanite F (539)	■	■	■

Crystal Effects

Transparent Effects

Crystal Golden Shadow F (001 GSHA)	■	■	■
Crystal Ignite (001 IGNIT)	■	■	■
Crystal Silver Shade F (001 SSHA)	■	■	■

4627 Thin Octagon Fancy Stone

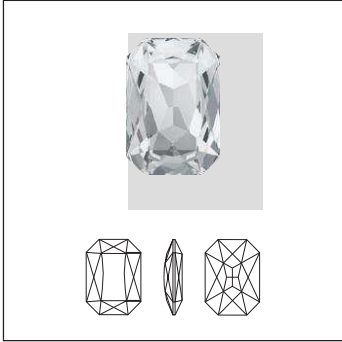

Siz
MM 27,0X 18,5
MM 37,0X 25,5

Crystal

Crystal F (001)

Colors

Plain Colors

Amethyst F (204)

Aquamarine F (202)

Black Diamond F (215)

Emerald F (205)

Jet (280)

Light Colorado Topaz F (246)

Montana F (207)

Tanzanite F (539)

Crystal Effects

Transparent Effects

Crystal AB F (001 AB)

Crystal Golden Shadow F (001 GSHA)

Crystal Silver Shade F (001 SSHA)

Crystal Vitrail Medium (001 VM)

4675

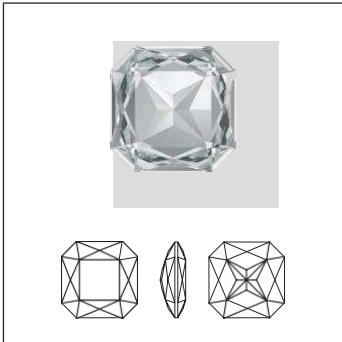

Siz
MM 23,0

Crystal

Crystal F (001)

Crystal Effects

Transparent Effects

Crystal Golden Shadow F (001 GSHA)

Crystal Silver Shade F (001 SSHA)

4678 Solaris FancyStone

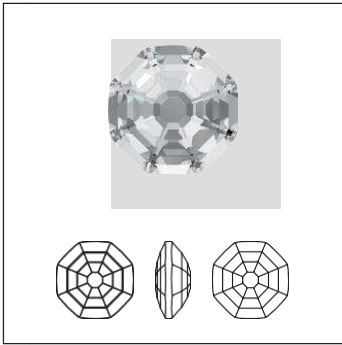

Size
MM 8,0
MM 14,0
MM 23,0

Crystal

Crystal F (001)

Crystal Effects

Transparent Effects

Crystal Silver Night (001 SIN)

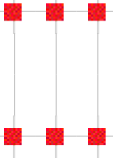

ATELIER MUNSTEINER FOR SWAROVSKI

DESIGNER EDITION

VISION HEXAGON FANCY STONE

The new Vision Designer Edition marks the first ever collaboration between Swarovski and Atelier Munsteiner, a German design house renowned for its multi-award-winning gemstone cuts, fine jewelry, and sculptures. The family-owned company's third-generation master craftsmen have drawn upon many years of experience to develop this stunning crystal innovation exclusively for Swarovski.

The Vision Designer Edition combines the uncomplicated appeal of simple cuts with the playfulness of mirrored reflections. These

ingeniously crafted design elements bring to mind frozen water, with mysteriously encapsulated air bubbles forming a perfectly geometrical, flower-like shape within the crystal. It is available in three of the most popular shapes for Jewelry and Accessories – the round, square, and hexagon – offering endless design possibilities and making it ideal for use in Glamorous and Progressive creations.

It is the subtlety in the simplicity that makes this Designer Edition truly "VISIONARY."

4681 Vision Hexagon Fancy Stone

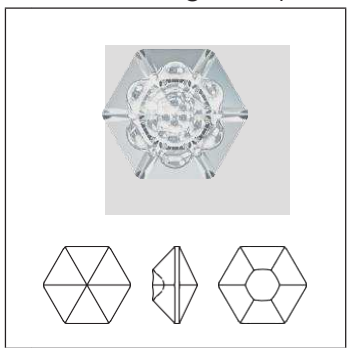

Size

MM 14,0

MM 18,0

Crystal

- Crystal F (001)

Colors

Plain Colors

- Light Siam F (227)
- Rose F (209)
- Tanzanite F (539)

Crystal Effects

Transparent Effects

- Crystal Antique Pink F (001 ANTP)
- Crystal Astral Pink F (001 API)
- Crystal Golden Shadow F (001 GSHA)
- Crystal Silver Night F (001 SINI)

THE VISION DESIGNER EDITION FAMILY



1681
12, 16 mm

chapter01 RoundStones
p. 122



4681
14, 18 mm

chapter02 FancyStones & Settings
p. 179



1681/S
12, 16 mm

chapter01 RoundStones
p. 122



4681/S
14, 18 mm

chapter02 FancyStones & Settings
p. 179

DESIGNER EDITIONS – DISTINCT PACKAGING

This Designer Edition will be labeled with the
"Designer Edition" imprint directly on the packaging.

4683 FANTASY HEXAGON FS



Siz	MM 7,8X 8,7	MM 10,0X 11,2	MM 12,0X 13,5	MM 14,0X 15,8
-----	-------------	---------------	---------------	---------------

Crystal

<input type="checkbox"/> Crystal F (001)	<input checked="" type="checkbox"/>	<input checked="" type="checkbox"/>	<input checked="" type="checkbox"/>	<input checked="" type="checkbox"/>
--	-------------------------------------	-------------------------------------	-------------------------------------	-------------------------------------

Colors

Plain Colors

<input type="checkbox"/> Amethyst F (204)	<input checked="" type="checkbox"/>	<input checked="" type="checkbox"/>	<input checked="" type="checkbox"/>	<input checked="" type="checkbox"/>
<input type="checkbox"/> Aquamarine F (202)	<input checked="" type="checkbox"/>	<input checked="" type="checkbox"/>	<input checked="" type="checkbox"/>	<input checked="" type="checkbox"/>
<input type="checkbox"/> Emerald F (205)	<input checked="" type="checkbox"/>	<input checked="" type="checkbox"/>	<input checked="" type="checkbox"/>	<input checked="" type="checkbox"/>
<input type="checkbox"/> Iris F (219)	<input checked="" type="checkbox"/>	<input checked="" type="checkbox"/>	<input checked="" type="checkbox"/>	<input checked="" type="checkbox"/>
<input type="checkbox"/> Jet (280)	<input checked="" type="checkbox"/>	<input checked="" type="checkbox"/>	<input checked="" type="checkbox"/>	<input checked="" type="checkbox"/>
<input type="checkbox"/> Light Colorado Topaz F (246)	<input checked="" type="checkbox"/>	<input checked="" type="checkbox"/>	<input checked="" type="checkbox"/>	<input checked="" type="checkbox"/>
<input type="checkbox"/> Majestic Blue F (296)	<input checked="" type="checkbox"/>	<input checked="" type="checkbox"/>	<input checked="" type="checkbox"/>	<input checked="" type="checkbox"/>
<input type="checkbox"/> Scarlet F (276)	<input checked="" type="checkbox"/>	<input checked="" type="checkbox"/>	<input checked="" type="checkbox"/>	<input checked="" type="checkbox"/>
<input type="checkbox"/> Tanzanite F (539)	<input checked="" type="checkbox"/>	<input checked="" type="checkbox"/>	<input checked="" type="checkbox"/>	<input checked="" type="checkbox"/>
<input type="checkbox"/> <u>Vintage Rose F (319)</u>	<input checked="" type="checkbox"/>	<input checked="" type="checkbox"/>	<input checked="" type="checkbox"/>	<input checked="" type="checkbox"/>

Opal Colors

<input type="checkbox"/> White Opal F (234)	<input checked="" type="checkbox"/>	<input checked="" type="checkbox"/>	<input checked="" type="checkbox"/>	<input checked="" type="checkbox"/>
---	-------------------------------------	-------------------------------------	-------------------------------------	-------------------------------------

Crystal Effects

Transparent Effects

<input type="checkbox"/> <u>Crystal Golden Shadow F (001_GSHA)</u>	<input checked="" type="checkbox"/>	<input checked="" type="checkbox"/>	<input checked="" type="checkbox"/>	<input checked="" type="checkbox"/>
<input type="checkbox"/> <u>Crystal Silver Night (001_SINI)</u>	<input checked="" type="checkbox"/>	<input checked="" type="checkbox"/>	<input checked="" type="checkbox"/>	<input checked="" type="checkbox"/>

Metallic Effects

<input type="checkbox"/> <u>Crystal Metallic Light Gold F (001_MLGLD)</u>	<input checked="" type="checkbox"/>	<input checked="" type="checkbox"/>	<input checked="" type="checkbox"/>	<input checked="" type="checkbox"/>
---	-------------------------------------	-------------------------------------	-------------------------------------	-------------------------------------

4699 KALEIDOSCOPE HEXAGON FS



Siz	MM 6,0X 6,9	MM 9,4X 10,8	MM 14,0X 16,0	MM 20,0X 22,9
-----	-------------	--------------	---------------	---------------

Crystal

Crystal F (001)	■	■	■	■
-----------------	---	---	---	---

Colors

Plain Colors

Amethyst F (204)	■	■	■	■
Aquamarine F (202)	■	■	■	■
Emerald F (205)	■	■	■	■
Jet (280)	■	■	■	■
Majestic Blue F (296)	■	■	■	■
Rose F (209)	■	■	■	■
Scarlet F (276)	■	■	■	■

Crystal Effects

Transparent Effects

Crystal AB F (001 AB)	■	■	■	■
Crystal Golden Shadow F (001 GSHA)	■	■	■	■
Crystal Silver Night (001 SINI)	■	■	■	■
Crystal Vitrail Medium F (001 VM)	■	■	■	■

Crystal Lacquer ^{Pro}

Crystal Laguna DeLite (001 L142D)	■	■	■	■
Crystal Lavender DeLite (001 L144D)	■	■	■	■
Crystal Lotus Pink DeLite (001 L145D)	■	■	■	■
Crystal Ocean DeLite (001 L143D)	■	■	■	■
Crystal Orange Glow DeLite (001 L146D)	■	■	■	■
Crystal Peach DeLite (001 L140D)	■	■	■	■
Crystal Royal Blue DeLite (001 L110D)	■	■	■	■
Crystal Royal Red DeLite (001 L107D)	■	■	■	■
Crystal Silky Sage DeLite (001 L147D)	■	■	■	■
Crystal Sunshine DeLite (001 L141D)	■	■	■	■

4706 Trilliant Fancy Stone



Siz	MM 7,0	MM 12,0	MM 17,0	MM 24,0
-----	--------	---------	---------	---------

Crystal

Crystal F (001)	■	■	■	■
-----------------	---	---	---	---

Colors

Plain Colors

Amethyst F (204)	■	■	■	■
Aquamarine F (202)	■	■	■	■
Iris F (219)	■	■		
Light Colorado Topaz F (246)	■	■	■	■
Rose F (209)	■	■	■	
Scarlet F (276)	■	■	■	
Tanzanite F (539)	■	■	■	■
Vintage Rose F (319)	■	■	■	■

Crystal Effects

Transparent Effects

Crystal AB F (001 AB)	■	■	■	■
Crystal Blue Shade F (001 BLSH)	■	■	■	■
Crystal Golden Shadow F (001 GSHA)	■	■	■	■
Crystal Ignite (001 IGNIT)	■	■	■	■
Crystal Luminous Green F (001 LUMG)	■	■	■	■
Crystal Silver Night (001 SINI)	■	■	■	■
Crystal Silver Shade F (001 SSHA)	■	■	■	■

4707 Slim Trilliant FancyStone

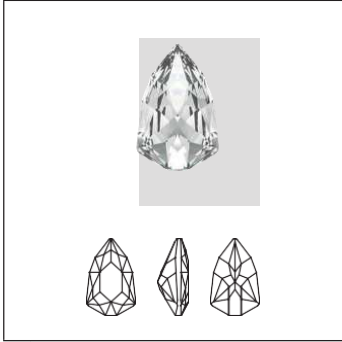

Siz	MM 7,8X 4,9	MM 13,6X 8,6	MM 18,7X 11,8	MM 24,0X 15,2
-----	-------------	--------------	---------------	---------------

Crystal

Crystal F (001)	■	■	■	■
-----------------	---	---	---	---

Colors

Plain Colors

Amethyst F (204)	■	■	■	■
Aquamarine F (202)	■	■	■	■
Emerald F (205)	■	■	■	■
Iris F (219)	■	■		
Light Colorado Topaz F (246)	■			
Montana F (207)	■	■	■	■
Rose F (209)	■	■		
Scarlet F (276)	■	■	■	
Tanzanite F (539)	■			
Vintage Rose F (319)	■	■	■	

Crystal Effects

Transparent Effects

Crystal AB F (001 AB)	■	■	■	■
Crystal Blue Shade F (001 BLSH)	■	■	■	■
Crystal Golden Shadow F (001 GSHA)	■	■	■	■
Crystal Silver Night (001 SINI)	■	■	■	■
Crystal Silver Shade F (001 SSHA)	■	■	■	■

4717 Delta FancyStone

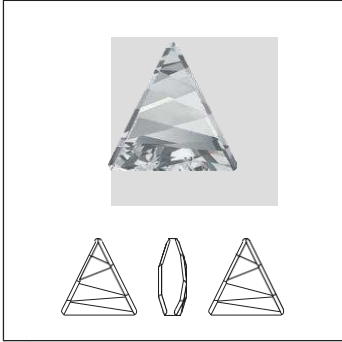

Siz	MM 15,5	MM 21,5

Crystal

<input type="checkbox"/>	Crystal F (001)	<input checked="" type="checkbox"/>	<input checked="" type="checkbox"/>
--------------------------	-----------------	-------------------------------------	-------------------------------------

Colors

Plain Colors

<input type="checkbox"/>	Aquamarine F (202)	<input checked="" type="checkbox"/>	
--------------------------	--------------------	-------------------------------------	--

<input type="checkbox"/>	Black Diamond F (215)	<input checked="" type="checkbox"/>	
--------------------------	-----------------------	-------------------------------------	--

<input type="checkbox"/>	Denim Blue F (266)	<input checked="" type="checkbox"/>	
--------------------------	--------------------	-------------------------------------	--

<input type="checkbox"/>	Montana F (207)	<input checked="" type="checkbox"/>	
--------------------------	-----------------	-------------------------------------	--

Crystal Effects

Transparent Effects

<input type="checkbox"/>	Crystal Antique Pink F (001 ANTP)	<input checked="" type="checkbox"/>	
--------------------------	-----------------------------------	-------------------------------------	--

<input type="checkbox"/>	Crystal Silver Shade F (001 SSHA)	<input checked="" type="checkbox"/>	
--------------------------	-----------------------------------	-------------------------------------	--

4722

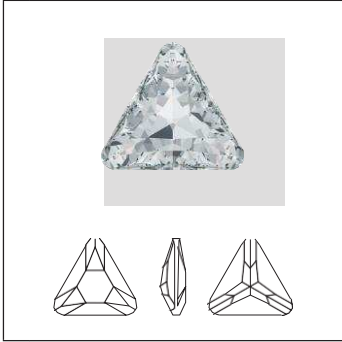

Crystal

Crystal F (001)

Size	
MM 4,0	<input type="checkbox"/>
MM 6,0	<input type="checkbox"/>
MM 8,0	<input checked="" type="checkbox"/>
MM 10,0	<input checked="" type="checkbox"/>

4731 Kite Fancy Stone

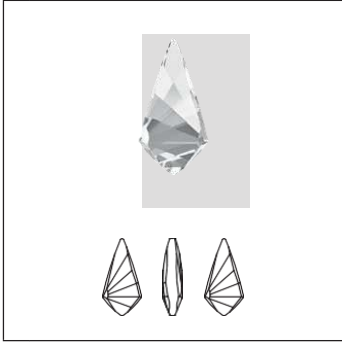

	Siz			
	MM 10,0X 5,0	MM 14,0X 7,0	MM 18,0X 9,0	MM 23,0X 11,5
Crystal				
Crystal F (001)	■	■	■	■
Colors				
Plain Colors				
Aquamarine F (202)	■	■	■	■
Erinite F (360)	■	■	■	■
Tanzanite F (539)	■	■	■	■
Crystal Effects				
Transparent Effects				
Crystal Antique Pink F (001 ANTP)	■	■	■	■
Crystal AB F (001 AB)	■	■	■	■
Crystal Blue Shade F (001 BLSH)	■	■	■	■
Crystal Golden Shadow F (001 GSHA)	■	■	■	■
Crystal Luminous Green F (001 LUMG)	■	■	■	■
Crystal Silver Night (001 SINI)	■	■	■	■
Crystal Silver Shade F (001 SSHA)	■	■	■	■

4739 CosmicFancyStone

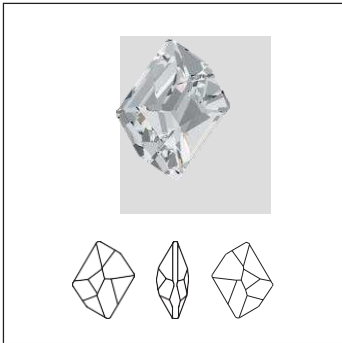

Siz
MM 14,0X 11,0
MM 20,0X 16,0

- Crystal**
- Crystal F (001)
- Colors**
- Plain Colors
- Aquamarine F (202)
 - Light Amethyst F (212)
 - Rose F (209)
- Crystal Effects**
- Transparent Effects
- Crystal Golden Shadow F (001 GSHA)
 - Crystal Silver Shade F (001 SSHA)

4744 Rivoli FlowerFancyStone

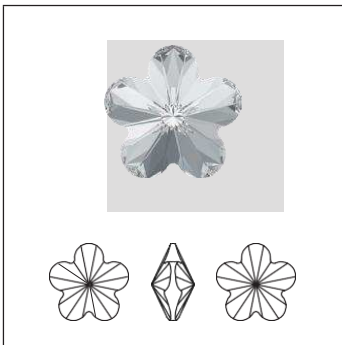

Siz
MM 6,0
MM 10,0

- Crystal**
- Crystal F (001)
- Colors**
- Plain Colors
- Aquamarine F (202)
 - Fuchsia F (502)
 - Light Rose F (223)
 - Violet F (371)
- Crystal Effects**
- Transparent Effects
- Crystal AB F (001 AB)

4745 Rivoli Star FancyStone

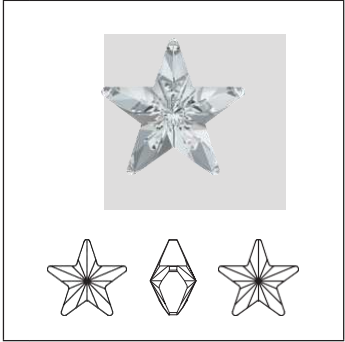

Siz	MM 5,0	MM 10,0
-----	--------	---------

- Crystal**
- Crystal F (001)
- Colors**
- Plain Colors
- Jet (280)
- Crystal Effects**
- Transparent Effects
- Crystal AB F (001 AB)
- Crystal Bermuda Blue F (001 BB)
- Crystal Golden Shadow F (001 GSHA)
- Crystal Silver Shade F (001 SSHA)
- Crystal Vitrail Light F (001 VL)
- Crystal Vitrail Medium F (001 VM)

Siz	MM 5,0	MM 10,0
-----	--------	---------

4748 Rivoli Butterfly FancyStone

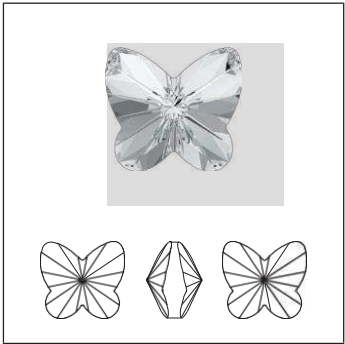

- Crystal**
- Crystal F (001)
- Colors**
- Plain Colors
- Aquamarine F (202)
- Light Rose F (223)
- Provence Lavender F (283)

4753 Edelweiss Fancy Stone

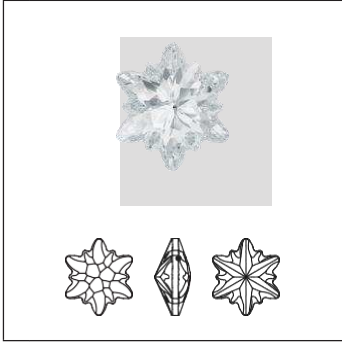

Size	MM 14,0	MM 18,0	MM 23,0
------	---------	---------	---------

Crystal

Crystal F (001)	<input checked="" type="checkbox"/>	<input checked="" type="checkbox"/>	<input checked="" type="checkbox"/>
-----------------	-------------------------------------	-------------------------------------	-------------------------------------

Colors

Plain Colors

Amethyst F (204)	<input checked="" type="checkbox"/>	<input checked="" type="checkbox"/>	<input type="checkbox"/>
------------------	-------------------------------------	-------------------------------------	--------------------------

Aquamarine F (202)	<input checked="" type="checkbox"/>	<input checked="" type="checkbox"/>	<input type="checkbox"/>
--------------------	-------------------------------------	-------------------------------------	--------------------------

Light Siam F (227)	<input checked="" type="checkbox"/>	<input checked="" type="checkbox"/>	<input type="checkbox"/>
--------------------	-------------------------------------	-------------------------------------	--------------------------

Opal Colors

White Opal F (234)	<input checked="" type="checkbox"/>	<input checked="" type="checkbox"/>	<input checked="" type="checkbox"/>
--------------------	-------------------------------------	-------------------------------------	-------------------------------------

4754 Starboom Fancy Stone

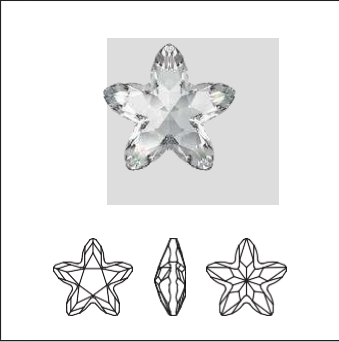

Siz	MM 8,0X 8,0	MM 13,0X 13,5	MM 18,0X 18,5
-----	-------------	---------------	---------------

Crystal

<input type="checkbox"/>	Crystal F (001)	<input checked="" type="checkbox"/>	<input checked="" type="checkbox"/>	<input checked="" type="checkbox"/>
--------------------------	-----------------	-------------------------------------	-------------------------------------	-------------------------------------

Colors

Plain Colors

<input type="checkbox"/>	Aquamarine F (202)	<input checked="" type="checkbox"/>	<input checked="" type="checkbox"/>	<input checked="" type="checkbox"/>
<input type="checkbox"/>	Jet (280)	<input checked="" type="checkbox"/>	<input checked="" type="checkbox"/>	<input checked="" type="checkbox"/>
<input type="checkbox"/>	Montana F (207)	<input checked="" type="checkbox"/>	<input checked="" type="checkbox"/>	<input checked="" type="checkbox"/>
<input type="checkbox"/>	Tanzanite F (539)	<input checked="" type="checkbox"/>	<input checked="" type="checkbox"/>	<input checked="" type="checkbox"/>

Crystal Effects

Transparent Effects

<input type="checkbox"/>	Crystal Antique Pink F (001 ANTP)	<input checked="" type="checkbox"/>	<input checked="" type="checkbox"/>	<input checked="" type="checkbox"/>
<input type="checkbox"/>	Crystal AB F (001 AB)	<input checked="" type="checkbox"/>	<input checked="" type="checkbox"/>	<input checked="" type="checkbox"/>
<input type="checkbox"/>	Crystal Bermuda Blue F (001 BB)	<input checked="" type="checkbox"/>	<input checked="" type="checkbox"/>	<input checked="" type="checkbox"/>
<input type="checkbox"/>	Crystal Blue Shade F (001 BLSH)	<input checked="" type="checkbox"/>	<input checked="" type="checkbox"/>	<input checked="" type="checkbox"/>
<input type="checkbox"/>	Crystal Golden Shadow F (001 GSHA)	<input checked="" type="checkbox"/>	<input checked="" type="checkbox"/>	<input checked="" type="checkbox"/>
<input type="checkbox"/>	Crystal Silver Shade F (001 SSHA)	<input checked="" type="checkbox"/>	<input checked="" type="checkbox"/>	<input checked="" type="checkbox"/>

4756 Galactic Flat Fancy Stone

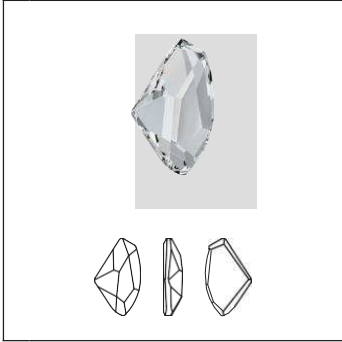

Siz

MM 19,0X 11,5
MM 27,0X 16,0
MM 39,0X 23,5

Crystal

Crystal F (001)

Colors

Plain Colors

Jet (280)

Crystal Effects

Transparent Effects

Crystal Golden Shadow F (001 GSHA)

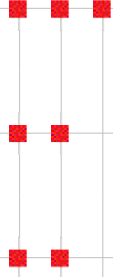

4757 Galactic FancyStone

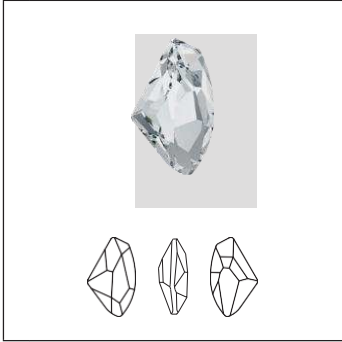

Siz

MM 14,0X 8,5

MM 19,0X 11,5

Crystal

Crystal F (001)

Colors

Plain Colors

Aquamarine F (202)

Crystal Effects

Transparent Effects

Crystal Golden Shadow F (001 GSHA)

4773 MeteorFancyStone

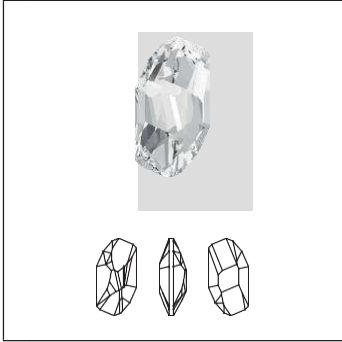

Siz	MM 14,0X 7,5	MM 18,0X 9,5	MM 28,0X 15,0
-----	--------------	--------------	---------------

Crystal

Crystal F (001)	<input checked="" type="checkbox"/>	<input checked="" type="checkbox"/>	<input checked="" type="checkbox"/>
-----------------	-------------------------------------	-------------------------------------	-------------------------------------

Colors

Plain Colors

Black Diamond F (215)	<input checked="" type="checkbox"/>	<input checked="" type="checkbox"/>	<input checked="" type="checkbox"/>
-----------------------	-------------------------------------	-------------------------------------	-------------------------------------

Crystal Effects

Transparent Effects

Crystal Antique Pink F (001 ANTP)	<input checked="" type="checkbox"/>	<input checked="" type="checkbox"/>	<input checked="" type="checkbox"/>
-----------------------------------	-------------------------------------	-------------------------------------	-------------------------------------

Crystal Blue Shade F (001 BLSH)	<input checked="" type="checkbox"/>	<input checked="" type="checkbox"/>	<input checked="" type="checkbox"/>
---------------------------------	-------------------------------------	-------------------------------------	-------------------------------------

4775 Eye Fancy Stone

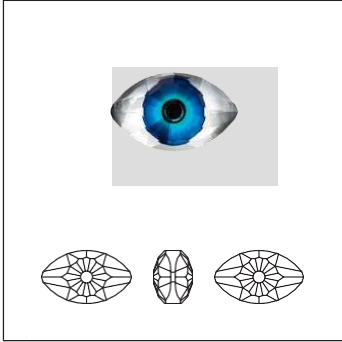

Siz

MM 18,0X 10,5

Crystal Effects

Metallic Effects

Crystal CAL V SI F MD291 (001 CAVSI)

Crystal CAL V SI F MD292 (001 CAVSI)

Crystal CAL V SI F MD293 (001 CAVSI)

Crystal CAL V SI F MD294 (001 CAVSI)

Crystal CAL V SI F MD290 (001 CAVSI)

*Please note, the line drawing has been rotated 90°.

4778 FatimaHand FancyStone



Siz

MM 18,0X 13,7

Crystal

Crystal F (001)

Colors

Plain Colors

Light Siam F (227)

Crystal Effects

Transparent Effects

Crystal Golden Shadow F (001 GSHA)

4784 Greek Cross Fancy Stone

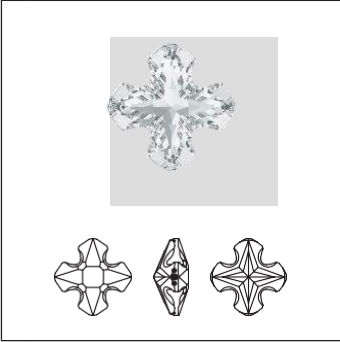

	Siz		
	MM 8,0	MM 14,0	MM 23,0
Crystal			
Crystal F (001)	■	■	■
Colors			
Plain Colors			
Jet (280)	■	■	■
Crystal Effects			
Transparent Effects			
Crystal Silver Night (001 SIN)	■	■	■
Crystal Vitrail Medium (001 VM)	■	■	■

4789 Shell FancyStone

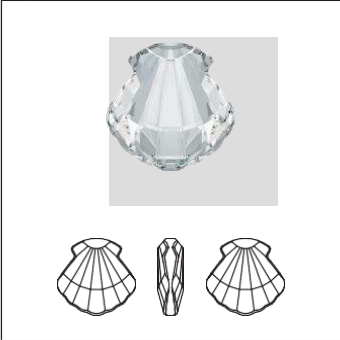

Siz
MM 14,0

Crystal

Crystal F (001)

Colors

Plain Colors

Aquamarine F (202)

Indicolite F (379)

Crystal Effects

Transparent Effects

Crystal Golden Shadow F (001 GSHA)

4790 Wing FancyStone



Siz
MM 18,0X 7,5
MM 23,0X 10,0

Crystal

Crystal F (001)

Colors

Plain Colors

Aquamarine F (202)

Provence Lavender F (283)

Tanzanite F (539)

Crystal Effects

Transparent Effects

Crystal Golden Shadow F (001 GSHA)

4795 Graphic FancyStone

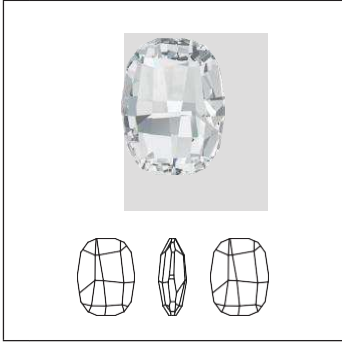

Siz	MM 14,0	MM 19,0	MM 28,0
Crystal F (001)	■	■	■
Denim Blue F (266)	■	■	■
Crystal Antique Pink F (001 ANTP)	■	■	■
Crystal Golden Shadow F (001 GSHA)	■	■	■

Crystal

Crystal F (001)

Colors

Plain Colors

Denim Blue F (266)

Crystal Effects

Transparent Effects

Crystal Antique Pink F (001 ANTP)

Crystal Golden Shadow F (001 GSHA)

4799 KALEIDOSCOPE HEXAGON FS



Siz	MM 6,0	MM 10,0	MM 14,0	MM 20,0
-----	--------	---------	---------	---------

Crystal

Crystal F (001)	■	■	■	■
-----------------	---	---	---	---

Colors

Plain Colors

Amethyst F (204)	■	■	■	■
Aquamarine F (202)	■	■	■	■
Emerald F (205)	■	■	■	■
Jet (280)	■	■	■	■
Majestic Blue F (296)	■	■	■	■
Rose F (209)	■	■	■	■
Scarlet F (276)	■	■	■	■

Crystal Effects

Transparent Effects

Crystal AB F (001 AB)	■	■	■	■
Crystal Golden Shadow F (001 GSHA)	■	■	■	■
Crystal Silver Night (001 SINI)	■	■	■	■
Crystal Vitrail Medium F (001 VM)	■	■	■	■

Crystal Lacquer ^{Pro}

Crystal Laguna DeLite (001 L142D)	■	■	■	■
Crystal Lavender DeLite (001 L144D)	■	■	■	■
Crystal Lotus Pink DeLite (001 L145D)	■	■	■	■
Crystal Ocean DeLite (001 L143D)	■	■	■	■
Crystal Orange Glow DeLite (001 L146D)	■	■	■	■
Crystal Peach DeLite (001 L140D)	■	■	■	■
Crystal Royal Blue DeLite (001 L110D)	■	■	■	■
Crystal Royal Red DeLite (001 L107D)	■	■	■	■
Crystal Silky Sage DeLite (001 L147D)	■	■	■	■
Crystal Sunshine DeLite (001 L141D)	■	■	■	■

4809 Sweet Heart Fancy Stone

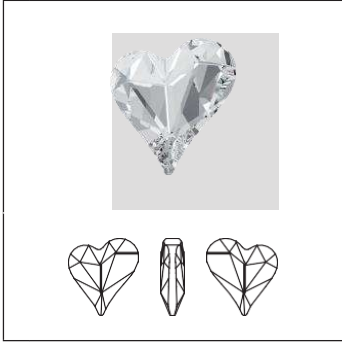

Siz	MM 13,0X 12,0	MM 17,0X 15,5	MM 27,0X 25,0
Crystal			
Crystal F (001)	■	■	■
Colors			
Plain Colors			
Amethyst F (204)	■	■	
Erinite F (360)		■	■
Light Siam F (227)	■		
Rose F (209)	■	■	
Violet F (371)		■	■
Crystal Effects			
Transparent Effects			
Crystal Antique Pink F (001 ANTP)		■	■
Crystal AB F (001 AB)	■	■	
Crystal Blue Shade F (001 BLSH)		■	■
Crystal Golden Shadow F (001 GSHA)	■	■	
Crystal Silver Night (001 SINI)	■	■	

Crystal

Crystal F (001)

Colors

Plain Colors

Amethyst F (204)

Erinite F (360)

Light Siam F (227)

Rose F (209)

Violet F (371)

Crystal Effects

Transparent Effects

Crystal Antique Pink F (001 ANTP)

Crystal AB F (001 AB)

Crystal Blue Shade F (001 BLSH)

Crystal Golden Shadow F (001 GSHA)

Crystal Silver Night (001 SINI)

4810 SweetHeart FancyStone

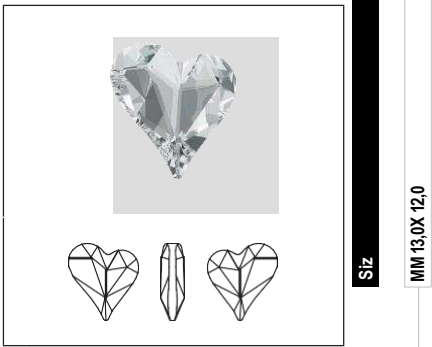

Siz

MM 13,0X 12,0

Crystal

Crystal F (001)

Colors

Plain Colors

Amethyst F (204)

Erinite F (360)

Rose F (209)

Violet F (371)

Crystal Effects

Transparent Effects

Crystal Antique Pink F (001 ANTP)

Crystal AB F (001 AB)

Crystal Blue Shade F (001 BLSH)

Crystal Golden Shadow F (001 GSHA)

Crystal Silver Night (001 SINI)

4827 RoundHeart FancyStone

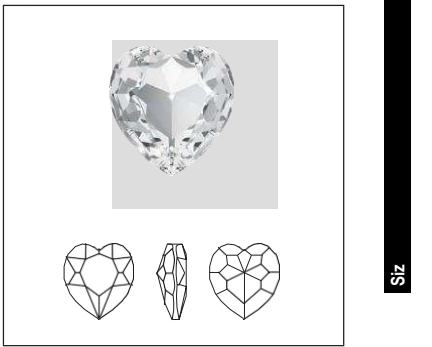

Siz

MM 28,0

Crystal

Crystal F (001)

Colors

Plain Colors

Light Amethyst F (212)

Crystal Effects

Transparent Effects

Crystal AB F (001 AB)

Crystal Bermuda Blue (001 BB)

Crystal Golden Shadow F (001 GSHA)

4831 Antique Heart Fancy Stone

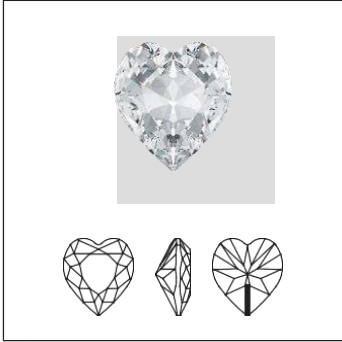

	MM 5,5X 5,0	MM 8,8X 8,0	MM 11,0X 10,0
Size			
Crystal			
Crystal F (001)	■	■	■
Colors			
Plain Colors			
Light Amethyst F (212)	■		
Light Rose F (223)	■		
Siam F (208)	■		

4841

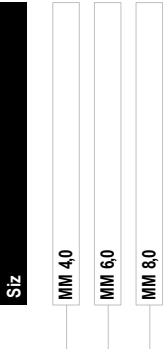
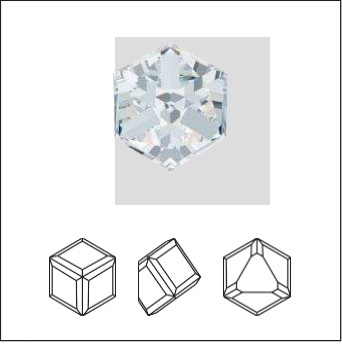

- Crystal**
- Crystal AB CAL VZ (001 ABCVZ)
- Crystal Effects**
- Transparent Effects**
- Crystal Bermuda Blue Z (001 BBZ)
- Crystal Gold. Shadow CAL'VZ' (001 GSCV)
- Crystal Heliotrope Z (001 HELZ)
- Crystal Vitrail Light Z (001 VLZ)
- Crystal Vitrail Medium Z (001 VMZ)
- Metallic Effects**
- Crystal Comet Arg. Light VZ (001 CAVZ)
- Color Effects**
- Aquamarine Comet Arg. Light VZ (202 CAVZ)
- Light Rose Comet Arg. Light VZ (223 CAVZ)
- Light Siam Comet Arg. Light VZ (227 CAVZ)
- Violet Comet Arg. Light VZ (371 CAVZ)

4869

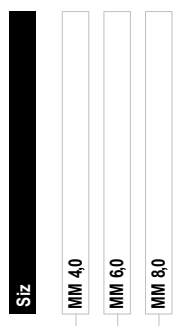
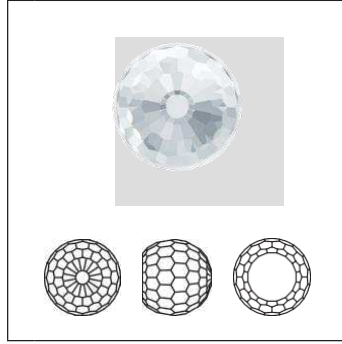

- Crystal**
- Crystal AB CAL VZ (001 ABCVZ)
- Crystal Effects**
- Transparent Effects**
- Crystal Vitrail Medium Z (001 VMZ)
- Metallic Effects**
- Crystal Comet Arg. Light VZ (001 CAVZ)
- Color Effects**
- Aquamarine Comet Arg. Light VZ (202 CAVZ)
- Light Rose Comet Arg. Light VZ (223 CAVZ)
- Violet Comet Arg. Light VZ (371 CAVZ)

4876 Female Symbol Fancy Stone

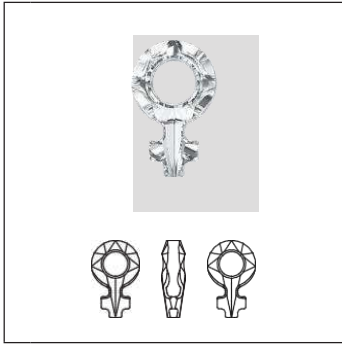

Siz
MM 18,0X 11,5
MM 30,0X 19,0

Crystal

- Crystal (001)
- Crystal F (001)

Crystal Effects

Transparent Effects

- Crystal Antique Pink (001 ANTP)
- Crystal Antique Pink F (001 ANTP)
- Crystal AB (001 AB)
- Crystal AB F (001 AB)
- Crystal Bermuda Blue F (001 BB)
- Crystal Bermuda Blue P (001 BB)
- Crystal Golden Shadow (001 GSHA)
- Crystal Golden Shadow F (001 GSHA)
- Crystal Silver Night (001 SINI)

4878 Male Symbol Fancy Stone



Siz
MM 18,0X 11,5
MM 30,0X 19,0

Crystal

- Crystal (001)
- Crystal F (001)

Crystal Effects

Transparent Effects

- Crystal Antique Pink (001 ANTP)
- Crystal Antique Pink F (001 ANTP)
- Crystal AB (001 AB)
- Crystal AB F (001 AB)
- Crystal Bermuda Blue F (001 BB)
- Crystal Bermuda Blue P (001 BB)
- Crystal Golden Shadow (001 GSHA)
- Crystal Golden Shadow F (001 GSHA)
- Crystal Silver Night (001 SINI)

¹ For details about the protective coating please refer to the chapter 'Basic Information.'

4883 MINI HEART FANCY STONE



Siz

MM 3,6X 3,1

Crystal

Crystal F (001)

Colors

Plain Colors

Amethyst F (204)

Aquamarine F (202)

Black Diamond F (215)

Emerald F (205)

Jet (280)

Light Colorado Topaz F (246)

Majestic Blue F (296)

Rose F (209)

Scarlet F (276)

Siam F (208)

Tanzanite F (539)

Crystal Effects

Transparent Effects

Crystal AB F (001 AB)

Crystal Golden Shadow F (001 GSHA)

4884 XILION Heart FancyStone

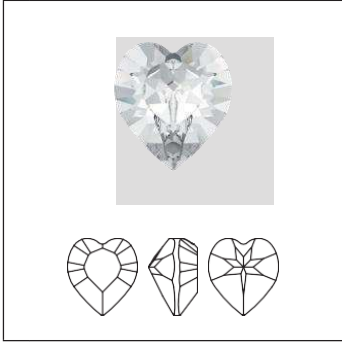

Siz	MM 5,5X 5,0	MM 6,6X 6,0	MM 8,8X 8,0	MM 11,0X 10,0
-----	-------------	-------------	-------------	---------------

Crystal

Crystal F (001)	■	■	■	■
-----------------	---	---	---	---

Colors

Plain Colors

Aquamarine F (202)	■	■	■	■
Light Amethyst F (212)	■	■	■	
Light Rose F (223)	■	■	■	
Light Siam F (227)	■	■	■	■
Montana F (207)	■	■	■	
Peridot F (214)	■	■	■	
Rose F (209)	■	■	■	

Crystal Effects

Transparent Effects

Crystal Golden Shadow F (001 GSHA)	■	■	■	
Crystal Ignite (001 IGNIT)	■	■	■	■

KAPUTT DESIGNED BY JEAN PAUL GAULTIER

DESIGNER EDITION

Design Story: While the whole world strives for perfection, Swarovski discovers the beauty of imperfection, guided and inspired by none other than design legend Jean Paul Gaultier. Together with Swarovski's own trend, design, and product management experts, Gaultier developed the spectacular Kaputt Collection exclusively for Swarovski. As its name, the German word for "broken," already suggests, the collection presents a technological innovation that deliberately breaks with convention. It celebrates the appeal of being different and unpredictable, which, according to the designer, is much more exciting than the precise and perfect.

Description: Broken and raw, but elegant at the same time, the Kaputt design captivates with distinctively irregular, partly unpolished, or frosted surfaces that give it an all-natural, almost meteoritic appearance. It comes in rich, shimmering metallic colors as well as classics such as Crystal and Crystal Golden Shadow, and boasts the famous Jean Paul Gaultier logo as a laser engraving.

Look: In a world of flawless, artificial beauty, Kaputt mirrors the attractiveness of irregular, natural surfaces for a down-to-earth look that is both rock and chic.

CRYSTAL SCARABAEUS GREEN DESIGNED BY JEAN PAUL GAULTIER

Design Story: Expressing his desire for an exclusive effect that would match his Kaputt Collection, haute couture icon Jean Paul Gaultier developed Crystal Scarabaeus Green together with a team of experts from Swarovski. For his effect he wanted this precise scintillating shade of green, combined with the mythological shimmer of the Egyptian scarab.

Description: Aptly named, Crystal Scarabaeus Green evokes the magic glow of the scarab, shimmering in green, blue, and purple with a metallic luster that combines bright and shadowy facets to create a stunningly graphic surface.

Look: With its beetle-like glow, Crystal Scarabaeus Green lends itself perfectly to nature-inspired and bold eco designs. It powerfully mimics nature and sets a rebellious statement for any eco-warrior. However, its shiny surface also evokes an otherworldly appearance that echoes futuristic, stellar avant-garde looks. The metallic rainbow hue caters to the sporty sci-fi appeal that celebrates state-of-the-art technology and transports us into other dimensions.

4921 Kaputt Oval Fancy Stone

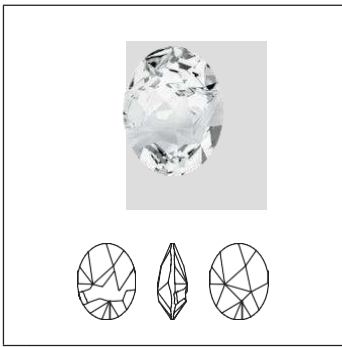

Siz

MM 23,0X 18,0

MM 29,0X 22,5

Crystal

Crystal F (001)

Crystal Effects

Transparent Effects

Crystal AB F (001 AB)

Crystal Silver Night (001 SINI)

Crystal Volcano F (001 VOL)

Metallic Effects

Crystal Light Chrome F (001 LTCH)

Crystal Metallic Blue F (001 METBL)

Crystal Scarabaeus Green F (001 SCGR)

4923 Kaputt Fancy Stone



Siz

MM 28,0X 24,0

MM 38,0X 33,0

Crystal

Crystal F (001)

Crystal Effects

Transparent Effects

Crystal Golden Shadow F (001 GSHA)

Crystal Silver Night (001 SINI)

Crystal Volcano F (001 VOL)

Metallic Effects

Crystal Light Chrome F (001 LTCH)

Crystal Metallic Blue F (001 METBL)

Crystal Scarabaeus Green F (001 SCGR)

4925 Kaputt Baguette Fancy Stone









Size
 MM 23,0X 9,0
 MM 29,0X 11,5

Crystal

- Crystal F (001)
- Crystal Effects
- Transparent Effects
- Crystal Silver Night (001 SINI)
- Crystal Volcano F (001 VOL)
- Metallic Effects
- Crystal Light Chrome F (001 LTCH)
- Crystal Metallic Blue F (001 METBL)
- Crystal Scarabaeus Green F (001 SCGR)

DESIGNER EDITION

THE KAPUTT DESIGNER EDITION FAMILY

	4921 Kaputt Oval Fancy Stone 23x18, 29x22.5 mm	chapter02 Fancy Stones & Settings p. 205		4925 Kaputt Baguette Fancy Stone 23x9, 29x11.5 mm	chapter02 Fancy Stones & Settings p. 206
	4921/S 23x18, 29x22.5 mm	chapter02 Fancy Stones & Settings p. 205		4925/S 23x9, 29x11.5 mm	chapter02 Fancy Stones & Settings p. 206
	4923 Kaputt Fancy Stone 28x24, 38x33 mm	chapter02 Fancy Stones & Settings p. 205		6911 Kaputt Oval Pendant 26, 36 mm	chapter06 Pendants p. 356
	4923/S 28x24, 38x33 mm	chapter02 Fancy Stones & Settings p. 205		6913 Kaputt Pendant 28, 40 mm	chapter06 Pendants p. 356

DESIGNER EDITIONS – DISTINCT PACKAGING

This Designer Edition will be labeled with the "Designer Edition" imprint directly on the packaging.

TRIBUTE TO TRIBE COLLECTION DESIGNED BY CÉLINE COUSTEAU

DESIGNER EDITION

Inspired by her project Tribes on the Edge and through experiences with indigenous tribes in the Brazilian rainforest, environmentalist and humanitarian Céline Cousteau presents her second Designer Edition for Swarovski: pristine tribal symbols that celebrate the interconnection of mankind to nature. The *Oval Tribe Fancy Stone* stands for a new design ethos where global references and mediums are mixed and matched to create a contemporary

appreciation of the remote and unknown. The *Rhombus Tribe Fancy Stone* is a beautiful rendition of a tribal inspired design, inviting us to embrace a multi-cultural future. As an international, almost universal symbol, the cross is deeply rooted in every culture. As such, the *Cross Tribe Pendant* incorporates the message of social responsibility, mutual respect and pluralism.

4926 Oval Tribe Fancy Stone

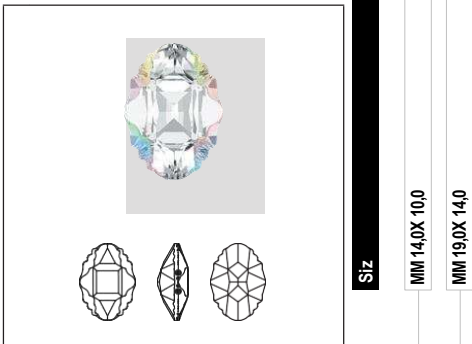

Crystal Effects		
Transparent Effects		
Crystal Aurore Boreale Z F (001 ABZ)	■	■
Color Effects		
Metallic Effects		
Aquamarine Metallic Blue Z F (202 MEBLZ)	■	■
Graphite Light Chrome Z F (253 LTCHZ)	■	■
Light Siam Met Lt Gold Z F (227 MLGDZ)	■	■
Peridot Scarabaeus Green Z F (214 SCGRZ)	■	■
Topaz Dorado Z F (203 DORZ)	■	■

4927 Rhombus Tribe Fancy Stone

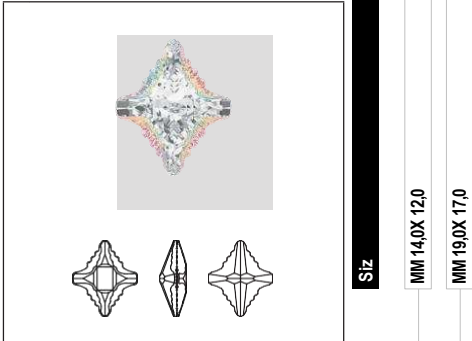

- Crystal Effects**
- Transparent Effects
- Crystal Aurore Boreale Z F (001 ABZ)
- Color Effects**
- Metallic Effects
- Aquamarine Metallic Blue Z F (202 MEBLZ)
- Graphite Light Chrome Z F (253 LTCHZ)
- Light Siam Met Lt Gold Z F (227 MLGDZ)
- Peridot Scarabaeus Green Z F (214 SCGRZ)
- Topaz Dorado Z F (203 DORZ)

THE CÉLINE COUSTEAU DESIGNER EDITION FAMILY

- 4926** Oval Tribe Fancy Stone
14x10, 19x14 mm
chapter02 Fancy Stones & Settings p. 207
- 4926/S**
14x10, 19x14 mm
chapter02 Fancy Stones & Settings p. 207
- 4927** Rhombus Tribe Fancy Stone
14x12, 19x17 mm
chapter02 Fancy Stones & Settings p. 208
- 4927/S**
14x12, 19x17 mm
chapter02 Fancy Stones & Settings p. 208

- 6868** Cross Tribe Pendant
14, 24 mm
chapter06 Pendants p. 355

DESIGNER EDITIONS – DISTINCT PACKAGING

This Designer Edition will be labeled with the "Designer Edition" imprint directly on the packaging.

ILLUSIONS DESIGNED BY CHRIS BANGLE

DESIGNER EDITION

A TILTED VIEW

Chris Bangle is no stranger to polarising, provocative designs. The now legendary former BMW Chief of Design, who left the company in 2009 to pursue other design passions and who has since opened up his own collaborative design studio in Piemonte, Italy, was famed during his tenure for aggressive, emotional car designs.

Small wonder this made him a perfect candidate to imagine crystals for Swarovski's Designer Edition Series that are both evocative and dimension defying. His tilted take on crystal geometry manages to exclude both space and dimension, even while appearing intrinsically flat. His crystalline form compresses the third dimension along its axis, leaving behind a decidedly 2.5D feel in a crystal that nevertheless retains volume.

4928 Tilted Chaton Fancy Stone



Crystal	
Crystal F (001)	■ ■
Crystal Effects	
Transparent Effects	
Crystal Copper Z F (001 COPZ)	■ ■
Crystal Tabac 2 VZ F (001 TA2VZ)	■ ■
Crystal Vitrail Medium 2 VZ F (001 VM2VZ)	■ ■
Metallic Effects	
Crystal Berm. Metal. Blue Z F (001 BMBZ)	■ ■

4929 Tilted Spike Fancy Stone

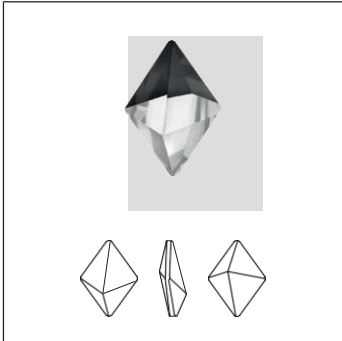

Siz

MM 14,0X 10,5

MM 24,0X 17,0

Crystal

- Crystal F (001)
- Crystal Berm. Blue Z CALVSI F (001 BBZCV)
- Crystal Moroda Z CALVSI F (001 MOZCV)
- Crystal Sahara Z CALVSI F (001 SAZCV)
- Crystal VMZ CALVSI F (001 VMZCV)

4933 Tilted Dice Fancy Stone

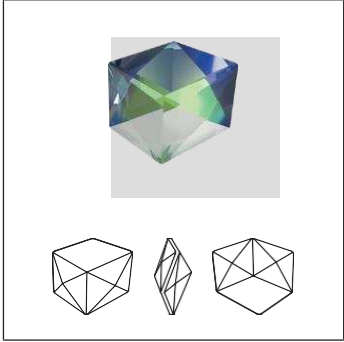

Siz	
MM19,0	MM27,0

Crystal

Crystal F (001)	<input checked="" type="checkbox"/>	<input checked="" type="checkbox"/>
Crystal Purple Z CALVSI F (001 PUZCV)	<input checked="" type="checkbox"/>	<input checked="" type="checkbox"/>
Crystal Sahara Z CALVSI F (001 SAZCV)	<input checked="" type="checkbox"/>	<input checked="" type="checkbox"/>
Crystal VMZ CALVSI F (001 VMZCV)	<input checked="" type="checkbox"/>	<input checked="" type="checkbox"/>

PRODUCT DETAILS

Article Size	Packing Unit = Minimum Order Quantity in Pieces	Average Net Weight in Gram per Packing Unit Crystal (001)	Average Gross Weight in Gram per Packing Unit Crystal (001)
4120			
6x4 mm	360	31.2	42.1
8x6 mm	180	44.7	45.2
14x10 mm	144	170.2	193.8
18x13 mm	48	112.3	132.9
25x18 mm	24	152.2	177.6
4120/S			
6x4 mm	360		41.9
8x6 mm	180		41.6
14x10 mm	144		86.0
18x13 mm	48		49.5
25x18 mm	24		48.8
4122			
8x6 mm	180	41.1	42.5
14x10.5 mm	108	127.0	150.5
18x13,5 mm	48	95.6	115.0
4122/S			
8x6 mm	180		41.8
14x10.5 mm	108		105.5
18x13,5 mm	48		79.0
4127			
30x22 mm	24	173.6	218.7
39x28 mm	12	226.8	246.4
4127/S			
30x22 mm	24		53.0
39x28 mm	12		64.4
4128			
6x4 mm	360	26.8	37.6
8x6 mm	360	76.5	87.3
10x8 mm	144	59.9	80.2
4128/S			
6x4 mm	360		40.7
8x6 mm	360		79.3
10x8 mm	144		80.0
4137			
15x11 mm	72	48.2	66.4
4139			
14 mm	72	53.2	82.7
20 mm	24	46.7	78.7
30 mm	18	124.6	153.0
4142			
10x8 mm	72	22.1	43.5
14x11 mm	36	36.4	56.6
18x14 mm	24	52.3	72.9
4142/S			
10x8 mm	72		20.0
14x11 mm	36		28.0
18x14 mm	24		30.0

Article Size	Packing Unit = Minimum Order Quantity in Pieces	Average Net Weight in Gram per Packing Unit Crystal (001)	Average Gross Weight in Gram per Packing Unit Crystal (001)
4161			
15x5 mm	72	29.5	51.6
21x7 mm	48	71.5	96.5
27x9 mm	24	65.8	94.2
4161/S			
15x5 mm	72		24.3
21x7 mm	48		27.0
27x9 mm	24		21.5
4195			
14 mm	24	33.1	53.8
18 mm	15	44.4	69.2
22 mm	6	31.4	52.8
4195/S			
14 mm	24		31.7
18 mm	15		33.1
22 mm	6		24.1
4196			
23x20 mm	16	113.2	141.2
30x26 mm	12	192.1	215.2
4196/S			
23x20 mm	16		41.8
30x26 mm	12		49.1
4200			
11x3 mm	360	28.6	39.4
15x4 mm	144	26.2	37.1
35x9.5 mm	16	41.9	63.8
48x13 mm	6	38.3	70.8
4200/S			
11x3 mm	360		64.9
15x4 mm	144		39.7
35x9.5 mm	16		34.1
48x13 mm	6		23.6
4224			
10x8 mm	144	51.4	63.3
14x11 mm	72	53.2	72.3
23x18 mm	36	59.8	79.4
4224/S			
10x8 mm	144		62.7
14x11 mm	72		55.5
23x18 mm	36		41.5
4227			
32x17 mm	24	100.8	123.4
4227/S			
32x17 mm	24		48.0

Article Size	Packing Unit = Minimum Order Quantity in Pieces	Average Net Weight in Gram per Packing Unit Crystal (001)	Average Gross Weight in Gram per Packing Unit Crystal (001)
4228			
4x2 mm	720	9.2	18.3
5x2.5 mm	720	18.9	28.0
6x3 mm	720	30.5	39.6
8x4 mm	360	32.9	42.0
10x5 mm	360	60.7	72.1
15x7 mm	144	63.9	88.1
4228/S			
5x2.5 mm	720		49.6
6x3 mm	720		71.4
8x4 mm	360		52.8
10x5 mm	360		81.6
15x7 mm	144		85.8
4230			
14x9 mm	144	75.1	98.8
19x12 mm	72	86.5	113.9
23x15 mm	48	102.8	123.0
4230/S			
14x9 mm	144		57.6
19x12 mm	72		72.0
23x15 mm	48		72.0
4320			
6x4 mm	360	25.7	34.8
8x6 mm	180	30.7	39.8
10x7 mm	144	48.6	68.9
14x10 mm	144	126.6	150.2
18x13 mm	48	85.2	105.8
4320/S			
6x4 mm	360		43.9
8x6 mm	180		39.7
10x7 mm	144		72.0
14x10 mm	144		126.1
18x13 mm	48		54.6
4322			
10x5 mm	72	13.95	33.93
14x7 mm	48	22.56	43.16
18x9 mm	24	24.72	45.45
22x11 mm	15	30.00	54.73
30x15 mm	12	54.00	74.10
4322/S			
10x5 mm	72		19.0
14x7 mm	48		22.0
18x9 mm	24		18.0
22x11 mm	15		20.0
30x15 mm	12		24.0
4327			
30x20 mm	24	161.8	206.8
40x27 mm	12	201.6	226.3
4327/S			
30x20 mm	24		51.5
40x27 mm	12		63.7

Article Size	Packing Unit = Minimum Order Quantity in Pieces	Average Net Weight in Gram per Packing Unit Crystal (001)	Average Gross Weight in Gram per Packing Unit Crystal (001)
4328			
6x3.6 mm	720	40.0	50.5
8x4.8 mm	360	42.1	53.0
10x6 mm	144	29.2	50.5
13x7.8 mm	144	65.1	88.3
4328/S			
6x3.6 mm	720		58.4
8x4.8 mm	360		57.1
10x6 mm	144		33.9
13x7.8 mm	144		51.2
4331			
11 mm	180	18.8	29.0
15 mm	96	20.4	50.0
20 mm	48	21.1	46.4
30 mm	24	36.0	58.4
4331/S			
11 mm	180		28.2
15 mm	96		27.5
20 mm	48		26.1
30 mm	24		36.8
4370			
11x10 mm	144	82.8	100.9
15.5x14 mm	72	107.3	127.4
20x18 mm	48	149.5	170.0
4370/S			
11x10 mm	144		78.6
15.5x14 mm	72		75.0
20x18 mm	48		77.1
4418			
6 mm	216	55.4	79.2
8 mm	216	119.9	147.8
4418/S			
6 mm	216		54.0
8 mm	216		138.2
4428			
1.5 mm	1,440	4.32	15.1
2 mm	1,440	12.2	23.0
3 mm	1,440	34.8	57.6
4 mm	1,440	108.5	119.5
5 mm	360	51.6	61.9
6 mm	360	88.55	93.0
8 mm	144	84.5	99.6
4428/S			
4 mm	1,440		104.5
5 mm	360		58.0
6 mm	360		50.0
8 mm	144		45.5

Article Size	Packing Unit = Minimum Order Quantity in Pieces	Average Net Weight in Gram per Packing Unit Crystal (001)	Average Gross Weight in Gram per Packing Unit Crystal (001)
4439			
14 mm	72	88.0	111.6
20 mm	24	80.4	123.0
30 mm	12	127.6	145.8
4447			
6 mm	360	87.5	98.3
8 mm	144	71.5	91.9
10 mm	144	133.9	157.2
12 mm	72	117.6	137.9
4447/S			
6 mm	360		50.0
8 mm	144		47.0
10 mm	144		70.5
12 mm	72		56.0
4461			
8 mm	144	56.9	77.2
12 mm	72	84.4	103.4
16 mm	72	214.4	238.0
4461/S			
8 mm	144		62.7
12 mm	72		52.8
16 mm	72		92.0
4470			
8 mm	72	28.7	77.8
10 mm	144	91.6	111.9
12 mm	72	74.7	92.9
18 mm	48	170.3	190.9
4470/S			
10 mm	144		54.5
12 mm	72		53.3
18 mm	48		92.0
4480			
6 mm	288	50.02	73.28
8 mm	144	65.95	87.79
10 mm	96	86.30	110.13
4480/S			
6 mm	288		100.00
8 mm	144		66.00
10 mm	96		53.50
4485			
6 mm	144	21.0	43.7
10.5 mm	96	81.6	103.6
17 mm	24	84.0	104.1
4485/S			
6 mm	144		33.9
10.5 mm	96		74.7
17 mm	24		52.8

Article Size	Packing Unit = Minimum Order Quantity in Pieces	Average Net Weight in Gram per Packing Unit Crystal (001)	Average Gross Weight in Gram per Packing Unit Crystal (001)
4500			
3x2 mm	1,440	20.5	32.0
6x2 mm	720	18.4	27.5
10x3 mm	360	36.6	47.6
4500/S			
6x2 mm	720		61.3
10x3 mm	360		68.5
4501			
4x2 mm	720	16.8	25.9
5x2 mm	720	18.1	27.2
5x2.5 mm	720	20.9	30.0
7x3 mm	720	60.2	71.1
10x5 mm	360	96.2	106.9
4501/S			
5x2.5 mm	720		65.1
7x3 mm	720		58.0
10x5 mm	360		150.6
4502			
3x1 mm	720	2.2	11.4
4503			
4x2 mm	720	14.2	33.9
6.3x2.4 mm	720	34.5	54.5
4524			
12x6 mm	144	67.7	89.4
16x8 mm	72	78.0	102.7
23x11 mm	36	104.0	131.9
4524/S			
12x6 mm	144		77.1
16x8 mm	72		64.9
23x11 mm	36		60.6
4527			
8x6 mm	144	53.7	64.6
14x10 mm	72	122.4	144.9
18x13 mm	72	246.9	270.6
4527/S			
8x6 mm	144		45.5
14x10 mm	72		60.3
18x13 mm	72		104.5
4547			
15x5 mm	72	37.4	58.9
21x7 mm	48	65.3	98.7
24x8 mm	48	97.4	130.5
30x10 mm	24	101.0	124.4
4547/S			
15x5 mm	72		36.8
21x7 mm	48		43.5
24x8 mm	48		50.5
30x10 mm	24		39.0

Article Size	Packing Unit = Minimum Order Quantity in Pieces	Average Net Weight in Gram per Packing Unit Crystal (001)	Average Gross Weight in Gram per Packing Unit Crystal (001)
4565			
14x10 mm	72	71.5	88.9
18x13 mm	48	101.2	121.8
4565/S			
14x10 mm	72		64.2
18x13 mm	48		69.9
4568			
8x6 mm	144	34.7	55.8
14x10 mm	72	74.9	103.1
18x13 mm	24	46.2	64.7
27x18 mm	20	105.8	132.7
4568/S			
8x6 mm	144		36.7
14x10 mm	72		54.0
18x13 mm	24		37.2
27x18 mm	20		61.0
4600			
6x4 mm	360	40.9	51.8
8x6 mm	144	41.2	52.2
10x8 mm	144	84.0	104.0
12x10 mm	144	146.7	170.3
4600/S			
6x4 mm	360		46.9
8x6 mm	144		39.7
10x8 mm	144		90.1
12x10 mm	144		127.5
4610			
14x10 mm	144	171.3	194.9
18x13 mm	48	124.9	145.5
20x15 mm	24	88.5	105.8
4610/S			
14x10 mm	144		104.5
18x13 mm	48		66.0
20x15 mm	24		51.0
4627			
27x18.5 mm	24	125.3	170.8
37x25.5 mm	12	170.7	197.8
4627/S			
27x18.5 mm	24		54.0
37x25.5 mm	12		60.1
4675			
23 mm	24	175.4	220.5
4675/S			
23 mm	24		73.8
4678			
8 mm	144	42.4	51.6
14 mm	48	81.3	102.7
23 mm	16	98.8	121.3

Article Size	Packing Unit = Minimum Order Quantity in Pieces	Average Net Weight in Gram per Packing Unit Crystal (001)	Average Gross Weight in Gram per Packing Unit Crystal (001)
4678/S			
8 mm	144		37.4
14 mm	48		38.4
23 mm	16		49.6
4681			
14 mm	72	88.5	108.2
18 mm	48	121.3	141.1
4681/S			
14 mm	72		69.2
18 mm	48		75.2
4706			
7 mm	144	23.7	44.4
12 mm	72	61.5	83.9
17 mm	48	96.4	119.8
24 mm	16	109.1	145.7
4706/S			
7 mm	144		28.8
12 mm	72		36.0
17 mm	48		81.6
24 mm	16		48.0
4707			
7.8x4.9 mm	144	23.1	46.84
13.6x8.6 mm	72	53.21	77.56
18.7x11.8 mm	48	87.22	112.32
24x15.2 mm	15	57.17	79.25
4707/S			
7.8x4.9 mm	144		39.0
13.6x8.6 mm	72		38.0
18.7x11.8 mm	48		46.5
24x15.2 mm	15		30.0
4717			
15.5 mm	72	139.9	148.3
21.5 mm	32	152.8	161.8
4717/S			
15.5 mm	72		86.0
21.5 mm	32		54.0
4722			
4 mm	480	12.0	21.1
6 mm	180	16.4	25.5
8 mm	144	29.0	48.1
10 mm	144	61.4	84.4
4722/S			
4 mm	480		40.2
6 mm	180		46.9
8 mm	144		45.1
10 mm	144		74.3

Article Size	Packing Unit = Minimum Order Quantity in Pieces	Average Net Weight in Gram per Packing Unit Crystal (001)	Average Gross Weight in Gram per Packing Unit Crystal (001)
4731			
10x5 mm	144	22.5	40.7
14x7 mm	96	38.6	56.8
18x9 mm	48	40.5	60.8
23x11.5 mm	30	54.2	79.5
4731/S			
10x5 mm	144		32.4
14x7 mm	96		35.3
18x9 mm	48		29.5
23x11.5 mm	30		28.6
4739			
14x11 mm	144	143.7	170.4
20x16 mm	72	200.7	229.8
4739/S			
14x11 mm	144		117.5
20x16 mm	72		112.3
4744			
6 mm	720	62.3	72.8
10 mm	288	126.0	158.1
4744/S			
6 mm	720		104.5
10 mm	288		93.0
4745			
5 mm	720	35.6	46.4
10 mm	144	48.5	71.3
4745/S			
5 mm	720		75.2
10 mm	144		43.0
4748			
5 mm	720	72.0	80.6
10 mm	288	195.8	241.9
4748/S			
5 mm	720		90.7
10 mm	288		162.1
4753			
14 mm	36	32.6	53.2
18 mm	24	42.9	60.3
23 mm	18	71.9	101.5
4753/S			
14 mm	36		34.6
18 mm	24		36.3
23 mm	18		44.9
4754			
8x8 mm	144	21.34	46.44
13x13.5 mm	72	45.79	67.76
18x18.5 mm	24	39.43	58.27

Article Size	Packing Unit = Minimum Order Quantity in Pieces	Average Net Weight in Gram per Packing Unit Crystal (001)	Average Gross Weight in Gram per Packing Unit Crystal (001)
4754/S			
8x8 mm	144		34.3
13x13.5 mm	72		48.1
18x18.5 mm	24		27.6
4756			
19x11.5 mm	96	112.5	171.3
27x16 mm	40	152.0	194.0
39x23.5 mm	24	226.2	258.1
4756/S			
19x11.5 mm	96		84.3
27x16 mm	40		66.1
39x23.5 mm	24		72.3
4757			
14x8.5 mm	96	82.6	104.8
19x11.5 mm	96	182.4	211.6
4757/S			
14x8.5 mm	96		65.2
19x11.5 mm	96		125.6
4773			
14x7.5 mm	72	43.1	64.8
18x9.5 mm	48	56.4	78.5
28x15 mm	20	90.7	111.1
4773/S			
14x7.5 mm	72		28.8
18x9.5 mm	48		48.0
28x15 mm	20		41.2
4775			
18x10.5 mm	24	42.14	62.87
4775/S			
18x10.5 mm	24		22.4
4775/C			
18x10.5 mm	24	28.8	33.6
4778			
18x13.7 mm	48	48.0	73.4
4778/S			
18x13.7 mm	48		45.5
4784			
8 mm	144	47.9	51.5
14 mm	72	57.7	81.1
23 mm	30	100.2	127.2
4784/S			
8 mm	144		46.9
14 mm	72		65.6
23 mm	30		73.1

Article Size	Packing Unit = Minimum Order Quantity in Pieces	Average Net Weight in Gram per Packing Unit Crystal (001)	Average Gross Weight in Gram per Packing Unit Crystal (001)
4789			
14 mm	72	100.8	129.2
4789/S			
14 mm	72		60.6
4790			
18x7.5 mm	108	72.3	97.1
23x10 mm	36	48.2	71.9
4790/S			
18x7.5 mm	108		85.9
23x10 mm	36		47.7
4795			
14 mm	72	72.0	106.9
19 mm	48	124.8	152.5
28 mm	24	204.0	254.8
4795/S			
14 mm	72		63.5
19 mm	48		80.5
28 mm	24		78.1
4809			
13x12 mm	72	47.8	68.5
17x15.5 mm	48	63.3	84.8
27x25 mm	16	86.3	100.0
4809/S			
13x12 mm	72		36.0
17x15.5 mm	48		48.0
27x25 mm	16		28.8
4810			
13x12 mm	72	48.4	69.1
4810/S			
13x12 mm	72		36.0
4827			
28 mm	24	214.9	253.3
4827/S			
28 mm	24		55.5
4831			
5.5x5 mm	360	26.5	37.3
8.8x8 mm	144	40.0	60.4
11x10 mm	144	80.1	101.5
4831/S			
5.5x5 mm	360		50.0
8.8x8 mm	144		46.9
11x10 mm	144		97.3
4841			
4 mm	288	45.3	66.6
6 mm	144	77.2	95.3
8 mm	72	89.2	107.4

Article Size	Packing Unit = Minimum Order Quantity in Pieces	Average Net Weight in Gram per Packing Unit Crystal (001)	Average Gross Weight in Gram per Packing Unit Crystal (001)
4869			
4 mm	480	36.2	45.3
6 mm	180	47.2	56.4
8 mm	144	90.8	109.0
4876			
18x11.5 mm	24	33.9	52.4
30x19 mm	10	45.2	66.9
4876/S			
18x11.5 mm	24		26.7
30x19 mm	10		24.7
4878			
18x11.5 mm	24	24.5	44.7
30x19 mm	10	51.4	73.2
4878/S			
18x11.5 mm	24		26.7
30x19 mm	10		24.7
4884			
5.5x5 mm	360	39.0	49.7
6.6x6 mm	360	67.2	78.0
8.8x8 mm	288	111.4	138.1
11x10 mm	144	107.3	127.4
15.4x14 mm	72	128.7	149.3
4884/S			
5.5x5 mm	360		49.6
6.6x6 mm	360		72.1
8.8x8 mm	288		46.9
11x10 mm	144		101.6
4921			
23x18 mm	15	63.3	88.0
29x22.5 mm	8	65.7	86.1
4921/S			
23x18 mm	15		31.6
29x22.5 mm	8		25.7
4923			
28x24 mm	8	38.9	60.0
38x33 mm	6	69.8	93.4
4923/S			
28x24 mm	8		25.2
38x33 mm	6		29.2
4925			
23x9 mm	20	37.6	60.2
29x11.5 mm	12	49.1	69.7
4925/S			
23x9 mm	20		32.3
29x11.5 mm	12		30.5

Article Size	Packing Unit = Minimum Order Quantity in Pieces	Average Net Weight in Gram per Packing Unit Crystal (001)	Average Gross Weight in Gram per Packing Unit Crystal (001)
4926			
14x10 mm	36	27.6	45.1
19x14 mm	24	47.0	63.0
4926/S			
14x10 mm	36		42.1
19x14 mm	24		48.3
4927			
14x12 mm	36	37.9	20.4
19x17 mm	24	44.2	26.6
4927/S			
14x12 mm	36		34.6
19x17 mm	24		39.6
4928			
12 mm	24	21.6	42.2
18 mm	24	63.4	83.4
4928/S			
12 mm	24		18.0
18 mm	24		35.0
4928/C			
12 mm	24	18.0	38.6
18 mm	24	34.8	63.7
4929			
14x10.5 mm	48	24.0	45.5
24x17 mm	15	28.8	53.5
4929/S			
14x10.5 mm	49		30.0
24x17 mm	15		25.0
4929/C			
14x10.5 mm	48	35.0	47.7
24x17 mm	15	27.8	48.4
4933			
19 mm	15	40.0	64.7
27 mm	8	59.2	78.3
4933/S			
19 mm	15		28.0
27 mm	8		29.0
4933/C			
19 mm	15	20.4	45.1
27 mm	8	29.9	51.7



BEADS

Beads offer the highest standard available on the market. The high-quality precision cutting and the clear through-hole achieve immense brilliance and clarity. Rounded hole edges reduce the wear on thread and increase the durability of designs. They are available in the latest fashion colors, effects, and cuts.

The wide range of colors and effects opens up endless possibilities for different combinations and designs. The main application techniques are beading, wiring, stringing, and weaving.

ALPHABETICAL ORDER

Air Blue Opal (285)
 Amethyst (204)
 AmethystAurore Boreale (204 AB)
 AmethystShimmer(204 SHIM)
 AmethystShimmer2x (204 SHIM2)
 Aquamarine (202)
 AquamarineAurore Boreale (202 AB)
 AquamarineSatin (202 SAT)*
 Black Diamond (215)
 Black DiamondAurore Boreale (215 AB)
 Black Diamond Shimmer(215 SHIM)
 Black Diamond Shimmer2x (215 SHIM2)
 Blue Zircon (229)
 Blue ZirconAurore Boreale (229 AB)
 BlushRose(257)
 Blush RoseAurore Boreale (257 AB)
 Burgundy (515)
 Capri Blue(243)
 Capri BlueAuroreBoreale (243 AB)
 Chrysolite (238)
 ChrysoliteAurore Boreale (238 AB)
 Chrysolite Opal (294)
 Citrine (249)
 Crystal (001)
 Crystal Antique Pink (001 ANTP)*
 Crystal Astral Pink (001 API)
 CrystalAurore Boreale (001 AB)
 CrystalAurore Boreale 2x (001 AB2)
 CrystalAurore Boreale FC (001 AB FC)
 CrystalAurore Boreale Satin (001 AB SAT)*
 Crystal Blue Shade (001 BLSH)*
 Crystal Bermuda Blue (001 BBL)*
 Crystal Bronze Shade (001 BRSH)*
 Crystal Bronze Shade FC (001 BRSHFC)*
 Crystal Comet Argent Light (001 CAL)*
 Crystal Comet Argent Light FC (001 CAL FC)*
 Crystal Copper (001 COP)*
 Crystal Dorado (001 DOR)*
 Crystal Dorado 2x (001 DOR2)*
 Crystal Golden Shadow (001 GSHA)
 Crystal Heliotrope (001 HEL)* Crystal
Iridescent Green (001 IRIG)*
Crystal Iridescent Green 2x (001 IRIG2)*
Crystal Iridescent Green FC (001 IRIGFC)*
Crystal Light Chrome (001 LTCH)*
Crystal Light Chrome 2x (001 LTCH2)*
Crystal Lilac Shadow (001 LLSH)
Crystal Luminous Green (001 LUJMG)*
 Crystal Metallic Blue (001 METBL)*
 Crystal Metallic Blue 2x (001 METBL2)*
 Crystal Metallic Blue FC (001 METBL2 FC)*
 Crystal Metallic Light Gold (001 MLGLD)*
 Crystal Metallic Light Gold 2x (001 MLGLD2)*
 Crystal Metallic Sunshine (001 METSH)*
 Crystal Metallic Sunshine 2x (001 METSH2)*
 Crystal Moonlight (001 MOL)
 Crystal Paradise Shine (001 PARSH)*
 Crystal Paradise Shine 2x (001 PARSH2)*
 Crystal Rainbow Dark 2x (001 RABDK)*
 Crystal Red Magma (001 REDM)* Crystal
Rose Gold (001 ROGL)*

Crystal Rose Gold 2x (001 ROGL2)*
 Crystal Satin (001 SAT)*
 Crystal Scarabaeus Green (001 SCGR)****
 Crystal Shimmer (001 SHIM)
 Crystal Shimmer2x (001 SHIM2)
 Crystal Silver Night (001 SINI)*
 Crystal Silver Night 2x (001 SINI2)*
 Crystal Silver Patina (001 SILPA)*
 Crystal Silver Shade (001 SSHA)
 Crystal Vitrail Medium (001 VM)*
 Cydaman Opal (398)
 Dark Indigo (288)
 Denim Blue (266)
 Emerald (205)
 EmeraldAurore Boreale (205 AB)
 Erinite (360)
 EriniteAurore Boreale (360 AB)
 Erinite Shimmer (360 SHIM)
 Erinite Shimmer2x (360 SHIM2)
 Fern Green (291)
 Fireopal (237)
 FireopalAurore Boreale (237 AB)
 Fuchsia (502)
 FuchsiaAurore Boreale (502 AB)
 Graphite (253)
 GraphiteAurore Boreale (253 AB)
 Greige (284)
 Hyacinth (236)
 HyacinthAurore Boreale (236 AB)
 Indian Pink (289)
 Indian Sapphire (217)
 Indian SapphireAurore Boreale (217 AB)
 Indicolite (379)
 IndicoliteAurore Boreale (379 AB)
 Jet (280)
 JetAurore Boreale (280 AB)
 Jet Hematite (280 HEM)*
 Jet Hematite 2x (280 HEM2)*
 Jonquil (213)
 JonquilAurore Boreale (213 AB)
 Jonquil Satin (213 SAT)*
 LightAmethyst (212)
 LightAmethystAurore Boreale (212 AB)
 LightAzore (361)
 LightAzoreAurore Boreale (361 AB)
 LightColorado Topaz (246)
 LightColorado TopazAurore Boreale (246 AB)
 LightColorado Topaz Shimmer (246 SHIM) Light
 LightColorado Topaz Shimmer2x (246 SHIM2) Light
 Grey Opal (383)
 LightPeach (362)
 LightPeachAurore Boreale (362 AB)
 LightPeach Satin (362 SAT)*
 LightRose (223)
 LightRoseAurore Boreale (223 AB)
 LightRose Satin (223 SAT)*
 LightSapphire (211)
 LightSapphireAurore Boreale (211 AB)
 LightSapphire Shimmer (211 SHIM) Light
 LightSapphire Shimmer2x (211 SHIM2) Light
 LightSiam (227)

LightSiamAurore Boreale (227 AB)
 LightSiam Satin (227 SAT)*
 LightSiam Shimmer (227 SHIM) Light
 LightSiam Shimmer2x (227 SHIM2) Light
 Silk (261)
 LightSmoked Topaz (221)
 LightSmoked TopazAurore Boreale (221 AB)
 LightTopaz (226)
 LightTopazAurore Boreale (226 AB)
 LightTopaz Shimmer (226 SHIM) Light
 LightTopaz Shimmer2x (226 SHIM2) Light
 Turquoise (263)
 Majestic Blue (296)¹
 Majestic BlueAurore Boreale (296 AB)
 Montana (207)
 MontanaAurore Boreale (207 AB)
 Olivine (228)
 OlivineAurore Boreale (228 AB)
 Pacific Opal (390)
 Padparadscha (542)
 Peridot (214)
 PeridotAurore Boreale (214 AB)
 Provence Lavender (283)
 Purple Velvet (277)
 Purple VelvetAurore Boreale (277 AB)
 Rosaline (508)
 Rose (209)
 RoseAurore Boreale (209 AB)
 Rose Satin (209 SAT)*
 Rose Peach (262)
 Rose Water Opal (395)
 Ruby (501)
 RubyAurore Boreale (501 AB)
 Sapphire (206)
 SapphireAurore Boreale (206 AB)
 Scarlet (276)
 ScarletAurore Boreale (276 AB)
 Siam (208)
 SiamAurore Boreale (208 AB)
 Silk (391)
 Smoked Topaz (220)
 Smoked TopazAurore Boreale (220 AB)
 Smoky Mauve (265)
 Smoky MauveAurore Boreale (265 AB)
 Sunflower (292)
 Tangerine (259)
 Tanzanite (539)
 TanzaniteAurore Boreale (539 AB)
 Topaz (203)
 TopazAurore Boreale (203 AB)
 Turquoise (267)
 TurquoiseAurore Boreale (267 AB)
 Vintage Rose (319)
 Violet (371)
 VioletAurore Boreale (371 AB)
 White Alabaster (281)
 White Opal (234)
 White OpalAurore Boreale (234 AB)
 Yellow Opal (231)
 Yellow OpalAurore Boreale (231 AB)

For details on available colors and effects for each article within the product groups, please see the product matrix of the respective item in the Collection 2018.

For color and effect samples, please see the corresponding color chart.

Please check the Swarovski Collection 2018 for all available crystal color and AB coating variations.

The plating resistance of effects is tested according to Swarovski's plating guidelines (SWAROVSKI-PROFESSIONAL.COM). Customers are advised to carry out their own tests if their plating parameters diverge from Swarovski plating guidelines.

* Crystals are not resistant to plating and similar processing.

*** designed by Jean Paul Gaultier

¹Majestic Blue's intense ultramarine hue is difficult to recreate accurately in print due to the fact that the CMYK color spectrum is used in the printing process.

In order to get a truer impression of its color, please use RGB digital pictures or, ideally, ask for actual samples.

Classic Colors/Effects: This color range offers a wide choice of traditional Swarovski crystal colors and effects.

Exclusive Colors/Effects: This color range is offered exclusively by Swarovski.

Colors and effects can appear different when illuminated with different light sources. Swarovski uses standard light source D50 for color decision and comparison. Slight changes in shades are unavoidable. Colors may vary according to cut and foiling.

The composition of Advanced Crystal is compliant with regulatory industry norms and laws regarding the restriction or prohibition of certain substances in the most relevant segments of our customers. Please note that the compliance of the crystal colors Citrine, Fireopal, Hyacinth, Light Siam, Siam, and Yellow Opal varies according to certain industry regulations. Those regulations are indicated with * in the compliance overview. Indian Siam and Scarlet (option to Lt. Siam) conform to all CLEAR-lists.



For further information please visit: SWAROVSKI-PROFESSIONAL.COM

Communication on Product-Assortment changes*

IMPORTANT INFORMATION ON ASSORTMENT ADJUSTMENTS

We would kindly like to inform you about overall portfolio streamlining as well as discontinuations of selected product lines, effective as of November 23rd, 2020.

In order to allow you sufficient time to prepare, upcoming changes are already visible in our B2B e-commerce platform. During this transition phase the collection has been marked with the following caption:

Caption - SUMMARY	
	OUT OF ASSORTMENT
	CHANGES IN THE ASSORTMENT
	NO CHANGES IN THE ASSORTMENT

Caption - MATRIX	
	OUT OF ASSORTMENT
	FUTURE MADE TO ORDER ITEM - MTO
	FUTURE MADE TO STOCK ITEM - MTS

*ASSORTMENT WILL BE VALID DURING THE TRANSITION PHASE: **NOV 23rd 2020 – March 31st 2021**
SMALL CHANGES CAN ACCURE DURING THIS TRANSITION PHASE

SUMMARY

1 2 3

COREASSORTMENT
5000
 2, 3, 4, 5, 6, 7, 8, 10, 12, 14 mm

1 2 3

5305
 5, 6 mm

1 2 3

5714
 8, 12 mm



5003
 6, 8, 10, 12, 14 mm

COREASSORTMENT
5328
 2.5, 3, 4, 5, 6, 8, 10 mm



5727
 14 mm



5005
 8, 12, 16 mm



5378
 14, 18 mm

5728
 12 mm

5020
 6, 8, 10 mm

5500
 9x6, 12x8 mm



5741
 8, 12 mm

5028/4
 6, 8, 10 mm



5514
 8x5.5, 10x7 mm

5742
 8, 10 mm



COREASSORTMENT
5040
 4, 6, 8, 12 mm

5515
 14x9.5, 18x12.5 mm

5744
 6, 8 mm

5041
 18 mm



5523
 12, 16 mm



5747
 12x6, 16x8 mm



5045
 6, 8 mm



5540
 12, 17 mm



5750
 13, 19 mm



5058
 10, 14 mm

5541
 11, 15 mm

5752
 8, 12 mm

5060
 5.5, 7.5 mm

5542
 8, 11 mm

5754
 6, 8, 10, 12 mm



5061
 5.5, 7.5 mm

5601
 4, 6, 8, 10, 12 mm

5950
 15, 30 mm

5062
 5.5, 7.5 mm

5621
 14, 18 mm

5951
 15, 30 mm



5200
 6x4, 7.5x5 mm

5624
 10, 14 mm

5043
 11 mm

CORE ASSORTMENT

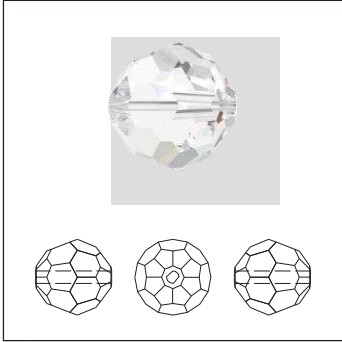
5000 Classic Bead



Size	MM 2,0	MM 3,0	MM 4,0	MM 5,0	MM 6,0	MM 7,0	MM 8,0	MM 10,0	MM 12,0	MM 14,0
------	--------	--------	--------	--------	--------	--------	--------	---------	---------	---------

Crystal

Crystal (001)	■	■	■	■	■	■	■	■	■	■
---------------	---	---	---	---	---	---	---	---	---	---

Colors

Plain Colors

Amethyst (204)	■	■	■	■	■	■	■	■	■	■
Aquamarine (202)	■	■	■	■	■	■	■	■	■	■
Black Diamond (215)		■	■	■	■	■	■	■	■	■
Blue Zircon (229)			■	■	■	■	■	■	■	■
Blush Rose (257)			■	■	■	■	■	■	■	■
Capri Blue (243)			■	■	■	■	■	■	■	■
Chrysolite (238)			■	■	■	■	■	■	■	■
Dark Indigo (288)			■	■	■	■	■	■	■	■
Denim Blue (266)			■	■	■	■	■	■	■	■
Emerald (205)	■	■	■	■	■	■	■	■	■	■
Erinite (360)			■	■	■	■	■	■	■	■
Fern Green (291)			■	■	■	■	■	■	■	■
Fireopal (237)			■	■	■	■	■	■	■	■
Fuchsia (502)	■	■	■	■	■	■	■	■	■	■
Graphite (253)			■	■	■	■	■	■	■	■
Greige (284)			■	■	■	■	■	■	■	■
Indian Pink (289)			■	■	■	■	■	■	■	■
Indicolite (379)			■	■	■	■	■	■	■	■
Iris (219)			■	■	■	■	■	■	■	■
Jet (280)	■	■	■	■	■	■	■	■	■	■
Jonquil (213)			■	■	■	■	■	■	■	■
Light Amethyst (212)			■	■	■	■	■	■	■	■
Light Azure (361)			■	■	■	■	■	■	■	■
Light Colorado Topaz (246)	■	■	■	■	■	■	■	■	■	■
Light Rose (223)	■	■	■	■	■	■	■	■	■	■
Light Sapphire (211)			■	■	■	■	■	■	■	■
Light Siam (227)		■	■	■	■	■	■	■	■	■
Light Silk (261)			■	■	■	■	■	■	■	■
Light Topaz (226)			■	■	■	■	■	■	■	■
Light Turquoise (263)		■	■	■	■	■	■	■	■	■
Majestic Blue (296)	■	■	■	■	■	■	■	■	■	■

	5000										
	Siz	MM 2,0	MM 3,0	MM 4,0	MM 5,0	MM 6,0	MM 7,0	MM 8,0	MM 10,0	MM 12,0	MM 14,0
Montana (207)				■		■		■			
Olivine (228)			■		■		■		■		
Padparadscha (542)			■		■		■		■		
Peridot (214)			■		■		■		■		
Purple Velvet (277)			■		■		■		■		
Rose (209)			■		■		■		■		
Rose Peach (262)			■		■		■		■		
Sapphire (206)			■		■		■		■		
Scarlet (276)		■	■		■		■	■	■		■
Siam (208)		■	■		■		■	■	■		■
Silk (391)			■		■		■		■		
Smoked Topaz (220)			■		■		■		■		
Smoky Mauve (265)			■		■		■		■		
Tanzanite (539)			■		■		■		■		
Topaz (203)			■		■		■		■		
Turquoise (267)			■		■		■		■		
Vintage Rose (319)			■		■		■		■		
Violet (371)			■		■		■		■		
White Alabaster (281)			■		■		■		■		
Opal Colors											
Cyclamen Opal (398)			■		■		■		■		
Pacific Opal (390)			■		■		■		■		
White Opal (234)		■	■		■		■		■		
Yellow Opal (231)			■		■		■		■		
Crystal Effects											
Transparent Effects											
Crystal Antique Pink (001 ANTP)			■		■		■		■		
Crystal AB (001 AB)		■	■	■	■	■	■	■	■	■	■
Crystal Blue Shade (001 BLSH)			■		■		■		■		
Crystal Bronze Shade (001 BRSH)			■		■		■		■		
Crystal Copper (001 COP)			■		■		■		■		
Crystal Golden Shadow (001 GSHA)		■	■	■	■	■	■	■	■	■	■
Crystal Lilac Shadow (001 LISH)			■		■		■		■		
Crystal Moonlight (001 MOL)		■	■	■	■	■	■	■	■	■	■
Crystal Paradise Shine (001 PARSH)			■		■		■		■		

5000	Siz	MM 2,0	MM 3,0	MM 4,0	MM 5,0	MM 6,0	MM 7,0	MM 8,0	MM 10,0	MM 12,0	MM 14,0
Crystal Satin (001 SATIN)				■		■		■			
Crystal Shimmer (001 SHIM)				■		■		■			
Crystal Silver Night (001 SINI)		■	■	■		■		■			
Crystal Silver Shade (001 SSHA)		■	■	■		■		■			
Crystal Vitrail Medium (001 VM)				■		■		■			
Metallic Effects											
Crystal Dorado (001 DOR)				■		■		■			
Crystal Iridescent Green (001 IRIG)			■	■		■		■			
Crystal Light Chrome (001 LTCH)			■	■		■		■			
Crystal Metallic Sunshine (001 METSH)			■	■		■		■			
Crystal MetallicLightGold 2x (001 MLG2)		■		■		■		■			
Crystal Rose Gold (001 ROGL)			■	■		■		■			
Full Coating											
Crystal AB 'FC' (001 ABFC)				■		■		■			
Crystal Astral Pink 'FC' (001 APFC)				■		■		■			
Crystal Bronze Shade 'FC' (001 BRSFC)				■		■		■			
Crystal CAL 'FC' (001 CAFC)				■		■		■			
Crystal Iridescent Green FC (001 IGFC)				■		■		■			
Crystal Metallic Blue 'FC' (001 MEBFC)				■		■		■			
Color Effects											
Amethyst AB (204 AB)				■		■		■			
Amethyst Shimmer (204 SHIM)				■		■		■			
Aquamarine AB (202 AB)				■		■		■			
Aquamarine Shimmer (202 SHIM)				■		■		■			
Black Diamond Shimmer (215 SHIM)				■		■		■			
Chrysolite Opal Shimmer (294 SHIM)				■		■		■			
Cyclamen Opal Shimmer (398 SHIM)				■		■		■			
Erinite Shimmer (360 SHIM)				■		■		■			
Jet AB (280 AB)				■		■		■			
Light Amethyst Shimmer (212 SHIM)				■		■		■			
Light Colorado Topaz Shimmer (246 SHIM)				■		■		■			
Light Rose AB (223 AB)				■		■		■			
Light Rose Shimmer (223 SHIM)				■		■		■			
Light Sapphire Shimmer (211 SHIM)				■		■		■			
Light Siam AB (227 AB)				■		■		■			

5000	Size	MM 2,0	MM 3,0	MM 4,0	MM 5,0	MM 6,0	MM 7,0	MM 8,0	MM 10,0	MM 12,0	MM 14,0
		Light Siam Shimmer (227 SHIM)			■		■		■		
Light Topaz Shimmer (226 SHIM)			■		■		■				
Pacific Opal Shimmer (390 SHIM)			■		■		■				
Peridot Shimmer (214 SHIM)			■		■		■				
Rose AB (209 AB)			■		■		■				
Rose Peach Shimmer (262 SHIM)			■		■		■				
Rose Shimmer (209 SHIM)			■		■		■				
Rose Water Opal Shimmer (395 SHIM)			■		■		■				
Siam Shimmer (208 SHIM)			■		■		■				
White Opal Shimmer (234 SHIM)			■		■		■				
Yellow Opal Shimmer (231 SHIM)			■		■		■				
Jet Hematite (280 HEM)		■	■		■		■				
Jet Hematite 2x (280 HEM2)			■		■		■				

5003

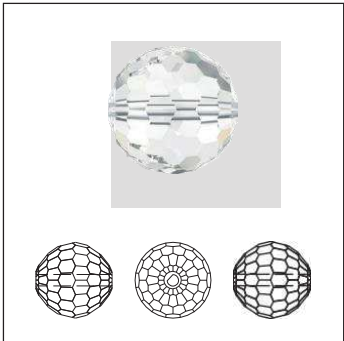

Siz

	MM 6,0	MM 8,0	MM 10,0	MM 12,0	MM 14,0
Crystal					
Crystal (001)	■	■	■	■	■
Crystal Effects					
Transparent Effects					
Crystal AB (001 AB)	■	■	■	■	■

5005 Chessboard Bead

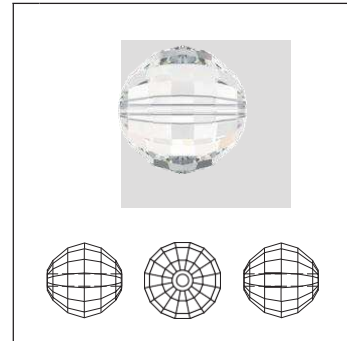

Siz

	MM 8,0	MM 12,0	MM 16,0
Crystal			
Crystal (001)	■	■	■
Crystal Effects			
Transparent Effects			
Crystal AB (001 AB)	■	■	■
Crystal Golden Shadow (001 GSHA)	■	■	■

5020 Helix Bead

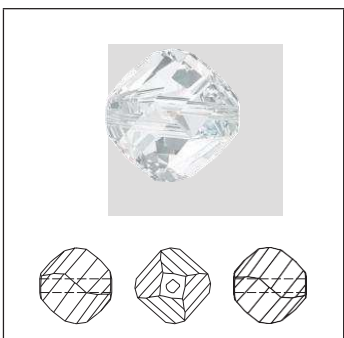

Siz

	MM 6,0	MM 8,0	MM 10,0
Crystal			
Crystal (001)	■	■	■
Crystal Effects			
Transparent Effects			
Crystal AB (001 AB)	■	■	■
Crystal Golden Shadow (001 GSHA)	■	■	■

5028/4 Crystal Globe Bead

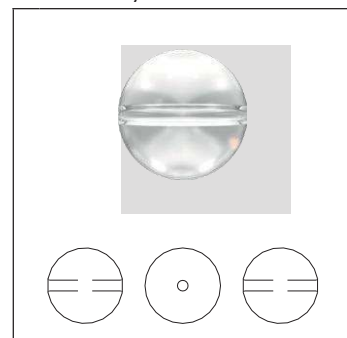

Siz

	MM 6,0	MM 8,0	MM 10,0
Crystal			
Crystal (001)	■	■	■
Crystal Effects			
Transparent Effects			
Crystal AB (001 AB)	■	■	■
Crystal Golden Shadow (001 GSHA)	■	■	■
Metallic Effects			
Crystal Iridescent Green (001 IRIG)	■	■	■
Crystal Metallic Sunshine (001 METSH)	■	■	■

CORE ASSORTMENT

5040 Briolette Bead

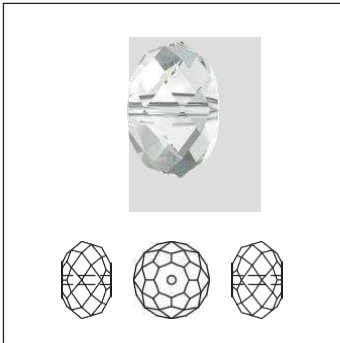

Siz	MM 4,0	MM 6,0	MM 8,0	MM 12,0
-----	--------	--------	--------	---------

Crystal

Crystal (001)	■	■	■	■
---------------	---	---	---	---

Colors

Plain Colors

Amethyst (204)	■	■	■	
Aquamarine (202)	■	■	■	
Black Diamond (215)		■	■	
Blush Rose (257)	■	■	■	
Denim Blue (266)		■	■	
Emerald (205)	■	■	■	
Erinite (360)		■	■	
Indicolite (379)		■	■	
Iris (219)		■	■	
Jet (280)	■	■	■	
Light Amethyst (212)		■	■	
Light Colorado Topaz (246)	■	■	■	
Light Rose (223)	■	■	■	
Light Sapphire (211)		■	■	
Light Siam (227)	■	■	■	
Light Topaz (226)		■	■	
Light Turquoise (263)		■	■	
Peridot (214)		■	■	
Purple Velvet (277)		■	■	
Rose Peach (262)		■	■	
Scarlet (276)	■	■	■	
Siam (208)		■	■	
Silk (391)		■	■	
Tanzanite (539)		■	■	
Violet (371)		■	■	

Crystal Effects

Transparent Effects

Crystal AB (001 AB)	■	■	■	■
Crystal Golden Shadow (001 GSHA)	■	■	■	■
Crystal Moonlight (001 MOL)		■	■	
Crystal Paradise Shine (001 PARSH)		■	■	

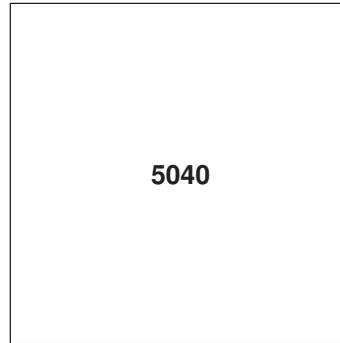

Siz	MM 4,0	MM 6,0	MM 8,0	MM 12,0
-----	--------	--------	--------	---------

Crystal Shimmer 2x (001 SHIM2)	■	■	■	
--------------------------------	---	---	---	--

Crystal Silver Night (001 SINI)	■	■	■	■
---------------------------------	---	---	---	---

Crystal Silver Shade (001 SSHA)	■	■	■	■
---------------------------------	---	---	---	---

Metallic Effects

Crystal Rainbow Dark 2x (001 RBDK2)		■	■	
-------------------------------------	--	---	---	--

Color Effects

Amethyst Shimmer 2x (204 SHIM2)	■	■	■	
Aquamarine Shimmer 2x (202 SHIM2)	■			
Black Diamond Shimmer 2x (215 SHIM2)		■	■	
Chrysolite Opal Shimmer 2x (294 SHIM2)		■	■	
Erinite Shimmer 2x (360 SHIM2)		■	■	
Light Amethyst Shimmer 2x (212 SHIM2)		■	■	
Light Colorado Topaz Shimmer 2x (246 SHIM2)	■	■	■	
Light Rose Shimmer 2x (223 SHIM2)	■	■	■	
Light Sapphire Shimmer 2x (211 SHIM2)		■	■	
Light Siam Shimmer 2x (227 SHIM2)	■	■	■	
Light Topaz Shimmer 2x (226 SHIM2)		■	■	
Pacific Opal Shimmer 2x (390 SHIM2)		■	■	
Rose Peach Shimmer 2x (262 SHIM2)		■	■	
Rose Water Opal Shimmer 2x (395 SHIM2)		■	■	
White Opal Shimmer 2x (234 SHIM2)		■	■	

5041 Briolette Bead (large hole)

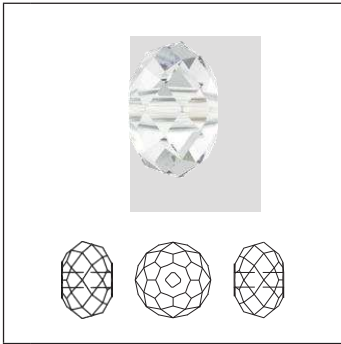

Siz
MM 18,0

Crystal

Crystal (001)

Crystal Effects

Transparent Effects

Crystal AB (001 AB)

Crystal Golden Shadow (001 GSHA)

5043 BRIOLETTE XXL HOLE BEAD

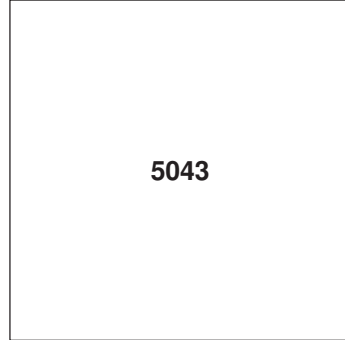

Siz
MM 11,0

Crystal Effects

Transparent Effects

Crystal Shimmer 2x (001 SHIM2)

Color Effects

Amethyst Shimmer 2x (204 SHIM2)

Aquamarine Shimmer 2x (202 SHIM2)

Emerald Shimmer 2x (205 SHIM2)

Jet Shimmer 2x (280 SHIM2)

Light Colorado Topaz Shimmer 2x (246 SHIM2)

Scarlet Shimmer 2x (276 SHIM2)

5045 Rondelle Bead

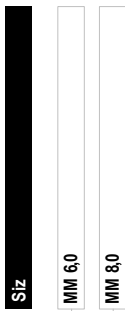

Crystal	
Crystal (001)	■ ■
Colors	
Plain Colors	
Emerald (205)	■ ■
Jet (280)	■ ■
Crystal Effects	
Transparent Effects	
Crystal AB (001 AB)	■ ■
Crystal Silver Night (001 SINI)	■ ■
Metallic Effects	
Crystal Light Chrome (001 LTCH)	■ ■

5058 Baroque Bead

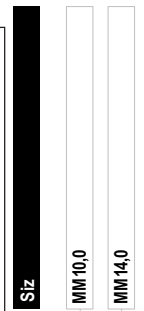
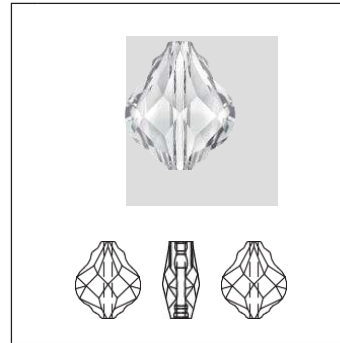

Crystal	
Crystal (001)	■ ■
Colors	
Plain Colors	
Amethyst (204)	■ ■
Aquamarine (202)	■ ■
Dark Indigo (288)	■ ■
Emerald (205)	■ ■
Jet (280)	■ ■
Light Smoked Topaz (221)	■ ■
Ruby (501)	■ ■
Crystal Effects	
Transparent Effects	
Crystal AB (001 AB)	■ ■
Crystal Golden Shadow (001 GSHA)	■ ■
Crystal Silver Night (001 SINI)	■ ■
Metallic Effects	
Crystal Rose Gold 2x (001 ROGL2)	■ ■

SPIKE BEADS

5060 Hexagon Spike Bead

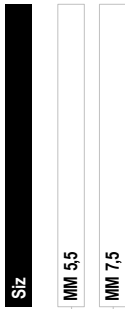
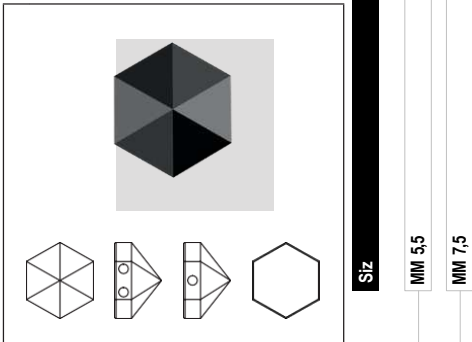

Crystal		MM 5,5	MM 7,5
Crystal (001)		■	■
Colors			
Plain Colors			
Jet (280)		■	■
Crystal Effects			
Transparent Effects			
Crystal AB (001 AB)		■	■
Crystal Blue Shade (001 BLSH)		■	■
Crystal Golden Shadow (001 GSHA)		■	■
Crystal Paradise Shine (001 PARSH)		■	■
Crystal Silver Night (001 SINI)		■	■
Metallic Effects			
Crystal Light Chrome (001 LTCH)		■	■
Crystal Metallic Blue (001 METBL)		■	■
Crystal Metallic Light Gold (001 MLGLD)		■	■
Crystal Rose Gold (001 ROGL)		■	■
Color Effects			
Jet Hematite (280 HEM)		■	■

5061 Square Spike Bead

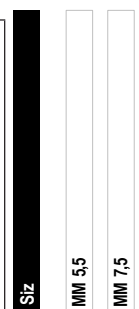
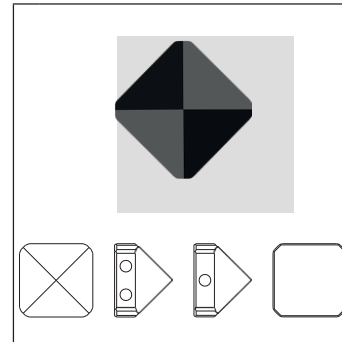

Crystal		MM 5,5	MM 7,5
Crystal (001)		■	■
Colors			
Plain Colors			
Jet (280)		■	■
Crystal Effects			
Transparent Effects			
Crystal AB (001 AB)		■	■
Crystal Blue Shade (001 BLSH)		■	■
Crystal Golden Shadow (001 GSHA)		■	■
Crystal Paradise Shine (001 PARSH)		■	■
Crystal Silver Night (001 SINI)		■	■
Metallic Effects			
Crystal Light Chrome (001 LTCH)		■	■
Crystal Metallic Blue (001 METBL)		■	■
Crystal Metallic Light Gold (001 MLGLD)		■	■
Crystal Rose Gold (001 ROGL)		■	■
Color Effects			
Jet Hematite (280 HEM)		■	■

5062 Round Spike Bead

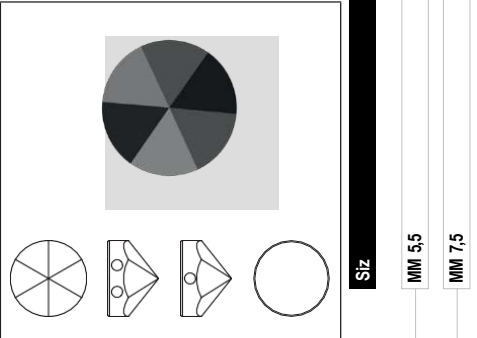

	MM 5,5	MM 7,5
Crystal		
Crystal (001)	■	■
Colors		
Plain Colors		
Jet (280)	■	■
Crystal Effects		
Transparent Effects		
Crystal AB (001 AB)	■	■
Crystal Blue Shade (001 BLSH)	■	■
Crystal Golden Shadow (001 GSHA)	■	■
Crystal Paradise Shine (001 PARSH)	■	■
Crystal Silver Night (001 SINI)	■	■
Metallic Effects		
Crystal Light Chrome (001 LTCH)	■	■
Crystal Metallic Blue (001 METBL)	■	■
Crystal Metallic Light Gold (001 MLGLD)	■	■
Crystal Rose Gold (001 ROGL)	■	■
Color Effects		
Jet Hematite (280 HEM)	■	■

5200

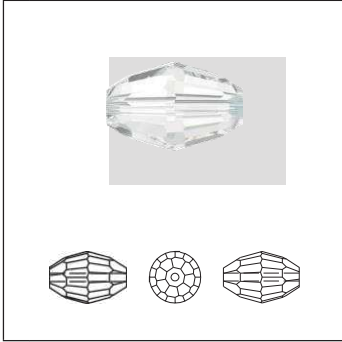

Siz
MM 6,0X 4,0
MM 7,5X 5,0

Crystal

Crystal (001)

Crystal Effects

Transparent Effects

Crystal AB (001 AB)

5305

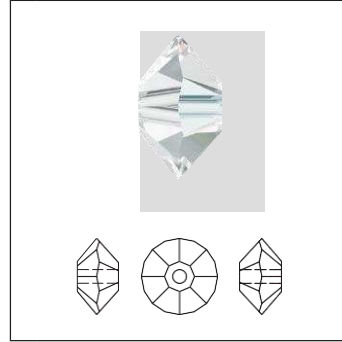

Siz
MM 5,0
MM 6,0

Crystal

Crystal (001)

Crystal Effects

Transparent Effects

Crystal AB (001 AB)

CORE ASSORTMENT

5328 XILION Bead

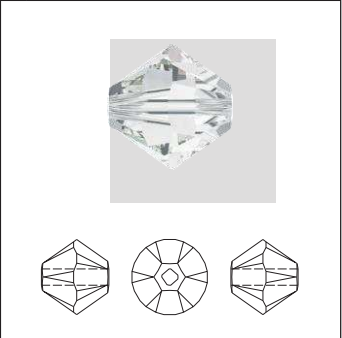

Size	MM 2,5	MM 3,0	MM 4,0	MM 5,0	MM 6,0	MM 8,0	MM 10,0
------	--------	--------	--------	--------	--------	--------	---------

Crystal

Crystal (001)	■	■	■	■	■	■	■
---------------	---	---	---	---	---	---	---

Colors

Plain Colors

Amethyst (204)	■	■	■	■	■	■	■
Aquamarine (202)	■	■	■	■	■	■	■
Black Diamond (215)	■	■	■	■	■	■	■
Blue Zircon (229)	■	■	■	■	■	■	■
Blush Rose (257)	■	■	■	■	■	■	■
Burgundy (515)	■	■	■	■	■	■	■
Capri Blue (243)	■	■	■	■	■	■	■
Chrysoite (238)	■	■	■	■	■	■	■
Citrine (249)	■	■	■	■	■	■	■
Dark Indigo (288)	■	■	■	■	■	■	■
Denim Blue (266)	■	■	■	■	■	■	■
Emerald (205)	■	■	■	■	■	■	■
Erinite (360)	■	■	■	■	■	■	■
Fern Green (291)	■	■	■	■	■	■	■
Fireopal (237)	■	■	■	■	■	■	■
Fuchsia (502)	■	■	■	■	■	■	■
Graphite (253)	■	■	■	■	■	■	■
Greige (284)	■	■	■	■	■	■	■
Hyacinth (236)	■	■	■	■	■	■	■
Indian Pink (289)	■	■	■	■	■	■	■
Indian Sapphire (217)	■	■	■	■	■	■	■
Indicolite (379)	■	■	■	■	■	■	■
Iris (219)	■	■	■	■	■	■	■
Jet (280)	■	■	■	■	■	■	■
Jonquil (213)	■	■	■	■	■	■	■
Light Amethyst (212)	■	■	■	■	■	■	■
Light Azure (361)	■	■	■	■	■	■	■
Light Colorado Topaz (246)	■	■	■	■	■	■	■
Light Peach (362)	■	■	■	■	■	■	■
Light Rose (223)	■	■	■	■	■	■	■
Light Sapphire (211)	■	■	■	■	■	■	■



Size	MM 2,5	MM 3,0	MM 4,0	MM 5,0	MM 6,0	MM 8,0	MM 10,0
------	--------	--------	--------	--------	--------	--------	---------

Light Siam (227)	■	■	■	■	■	■	■
Light Silk (261)	■	■	■	■	■	■	■
Light Smoked Topaz (221)	■	■	■	■	■	■	■
Light Topaz (226)	■	■	■	■	■	■	■
Light Turquoise (263)	■	■	■	■	■	■	■
Majestic Blue (296)	■	■	■	■	■	■	■
Montana (207)	■	■	■	■	■	■	■
Olivine (228)	■	■	■	■	■	■	■
Padparadscha (542)	■	■	■	■	■	■	■
Peridot (214)	■	■	■	■	■	■	■
Provence Lavender (283)	■	■	■	■	■	■	■
Purple Velvet (277)	■	■	■	■	■	■	■
Rosaline (508)	■	■	■	■	■	■	■
Rose (209)	■	■	■	■	■	■	■
Rose Peach (262)	■	■	■	■	■	■	■
Ruby (501)	■	■	■	■	■	■	■
Sapphire (206)	■	■	■	■	■	■	■
Scarlet (276)	■	■	■	■	■	■	■
Siam (208)	■	■	■	■	■	■	■
Silk (391)	■	■	■	■	■	■	■
Smoked Topaz (220)	■	■	■	■	■	■	■
Smoky Mauve (265)	■	■	■	■	■	■	■
Sunflower (292)	■	■	■	■	■	■	■
Tangerine (259)	■	■	■	■	■	■	■
Tanzanite (539)	■	■	■	■	■	■	■
Topaz (203)	■	■	■	■	■	■	■
Turquoise (267)	■	■	■	■	■	■	■
Vintage Rose (319)	■	■	■	■	■	■	■
Violet (371)	■	■	■	■	■	■	■
White Alabaster (281)	■	■	■	■	■	■	■

Opal Colors

Air Blue Opal (285)	■	■	■	■	■	■	■
Chrysoite Opal (294)	■	■	■	■	■	■	■
Cyclamen Opal (398)	■	■	■	■	■	■	■
Light Grey Opal (383)	■	■	■	■	■	■	■

5328	Siz							
		MM 2,5	MM 3,0	MM 4,0	MM 5,0	MM 6,0	MM 8,0	MM 10,0
Pacific Opal (390)			■	■	■	■		
Rose Water Opal (395)			■	■				
White Opal (234)			■	■	■	■		
Yellow Opal (231)			■	■				
Crystal Effects								
Transparent Effects								
Crystal AB SATIN (001 ABSAT)			■	■				
Crystal Antique Pink (001 ANTP)			■	■	■	■		
Crystal Astral Pink (001 API)			■	■	■	■		
Crystal AB (001 AB)		■	■	■	■	■	■	■
Crystal Aurore Boreale 2x (001 AB2)			■	■	■	■		
Crystal Blue Shade (001 BLSH)			■	■	■	■		
Crystal Bronze Shade (001 BRSH)			■	■				
Crystal Copper (001 COP)			■	■	■	■		
Crystal Golden Shadow (001 GSHA)		■	■	■	■	■	■	
Crystal Heliotrope (001 HEL)			■	■				
Crystal Lilac Shadow (001 LISH)			■	■	■	■		
Crystal Luminous Green (001 LUMG)			■	■	■	■		
Crystal Moonlight (001 MOL)			■	■	■	■		
Crystal Paradise Shine (001 PARSH)			■	■	■	■		
Crystal Paradise Shine 2x (001 PARS2)				■				
Crystal Red Magma (001 REDM)			■	■				
Crystal Satin (001 SATIN)			■	■				
Crystal Shimmer (001 SHIM)			■	■	■	■		
Crystal Shimmer 2x (001 SHIM2)			■	■				
Crystal Silver Night (001 SINI)			■	■	■	■	■	
Crystal Silver Shade (001 SSHA)		■	■	■	■	■	■	
Crystal Vitrail Medium (001 VM)			■	■		■		
Metallic Effects								
Crystal Comet Argent Light (001 CAL)			■	■	■	■		
Crystal Dorado 2x (001 DOR2)			■	■	■	■		
Crystal Iridescent Green (001 IRIG)			■	■	■	■		
Crystal Iridescent Green 2x (001 IRIG2)				■				
Crystal Light Chrome (001 LTCH)			■	■	■	■		
Crystal Light Chrome 2x (001 LTCH2)				■				

5328	Siz							
		MM 2,5	MM 3,0	MM 4,0	MM 5,0	MM 6,0	MM 8,0	MM 10,0
Crystal Metallic Blue 2x (001 MEBL2)			■	■	■	■		
Crystal Metallic Sunshine (001 METSH)			■	■	■	■		
Crystal Metallic Sunshine 2x (001 MTSH2)				■				
Crystal MetallicLightGold 2x (001 MLG2)			■	■	■	■		
Crystal Rainbow Dark 2x (001 RBDK2)					■	■		
Crystal Rose Gold (001 ROGL)			■	■	■	■		
Crystal Rose Gold 2x (001 ROGL2)			■	■	■	■		
Crystal Scarabaeus Green (001 SCGR)			■	■	■	■		
Color Effects								
Amethyst AB (204 AB)			■	■	■	■		
Amethyst Aurore Boreale 2x (204 AB2)				■				
Amethyst Shimmer (204 SHIM)			■	■	■	■		
Amethyst Shimmer 2x (204 SHIM2)			■	■				
Aquamarine AB (202 AB)			■	■	■	■		
Aquamarine Aurore Boreale 2x (202 AB2)				■				
Aquamarine Satin (202 SATIN)				■				
Aquamarine Shimmer (202 SHIM)			■	■	■	■		
Aquamarine Shimmer 2x (202 SHIM2)			■	■				
Black Diamond AB (215 AB)			■	■	■	■		
Black Diamond Aurore Boreale 2x (215 AB2)				■				
Black Diamond Shimmer (215 SHIM)			■	■	■	■		
Black Diamond Shimmer 2x (215 SHIM2)			■	■				
Blue Zircon AB (229 AB)				■				
Blue Zircon Aurore Boreale 2x (229 AB2)				■				
Blush Rose AB (257 AB)				■				
Blush Rose Aurore Boreale 2x (257 AB2)				■				
Capri Blue AB (243 AB)			■	■				
Capri Blue Aurore Boreale 2x (243 AB2)				■				
Chrysolite AB (238 AB)				■				
Chrysolite Aurore Boreale 2x (238 AB2)				■				
Chrysolite Opal Shimmer (294 SHIM)			■	■	■	■		
Chrysolite Opal Shimmer 2x (294 SHIM2)			■	■				
Cyclamen Opal Shimmer (398 SHIM)			■	■	■	■		
Cyclamen Opal Shimmer 2x (398 SHIM2)			■	■				
Emerald AB (205 AB)			■	■				

5328	Siz							
		MM 2,5	MM 3,0	MM 4,0	MM 5,0	MM 6,0	MM 8,0	MM 10,0
Emerald Aurore Boreale 2x (205 AB2)				■				
Erinite AB (360 AB)				■				
Erinite Shimmer (360 SHIM)		■	■	■	■			
Erinite Shimmer 2x (360 SHIM2)		■	■					
Fireopal AB (237 AB)				■				
Fireopal Aurore Boreale 2x (237 AB2)				■				
Fuchsia AB (502 AB)		■	■					
Fuchsia Aurore Boreale 2x (502 AB2)				■				
Graphite AB (253 AB)				■				
Graphite Aurore Boreale 2x (253 AB2)				■				
Hyacinth AB (236 AB)				■				
Hyacinth Aurore Boreale 2x (236 AB2)				■				
Indian Sapphire AB (217 AB)				■				
Indicolite AB (379 AB)				■				
Iris AB (219 AB)		■	■	■	■			
Iris Aurore Boreale 2x (219 AB2)		■	■					
Jet AB (280 AB)		■	■	■	■			
Jet Aurore Boreale 2x (280 AB2)		■	■					
Jonquil AB (213 AB)				■				
Jonquil Aurore Boreale 2x (213 AB2)				■				
Jonquil Satin (213 SATIN)				■				
Light Amethyst AB (212 AB)		■	■					
Light Amethyst Aurore Boreale 2x (212 AB2)				■				
Light Amethyst Shimmer (212 SHIM)		■	■	■	■			
Light Amethyst Shimmer 2x (212 SHIM2)		■	■					
Light Azure AB (361 AB)				■				
Light Azure Aurore Boreale 2x (361 AB2)				■				
Light Colorado Topaz AB (246 AB)		■	■	■	■			
Light Colorado Topaz Aurore Boreale 2x (246 AB2)				■				
Light Colorado Topaz Shimmer (246 SHIM)		■	■	■	■			
Light Colorado Topaz Shimmer 2x (246 SHIM2)		■	■					
Light Peach AB (362 AB)				■				
Light Peach Satin (362 SATIN)				■				
Light Rose AB (223 AB)		■	■	■	■			
Light Rose Aurore Boreale 2x (223 AB2)		■	■					

5328	Siz							
		MM 2,5	MM 3,0	MM 4,0	MM 5,0	MM 6,0	MM 8,0	MM 10,0
Light Rose Satin (223 SATIN)				■				
Light Rose Shimmer (223 SHIM)		■	■	■	■			
Light Rose Shimmer 2x (223 SHIM2)		■	■					
Light Sapphire AB (211 AB)		■	■					
Light Sapphire Aurore Boreale 2x (211 AB2)				■				
Light Sapphire Shimmer (211 SHIM)		■	■	■	■			
Light Sapphire Shimmer 2x (211 SHIM2)		■	■					
Light Siam AB (227 AB)		■	■	■	■			
Light Siam Aurore Boreale 2x (227 AB2)				■				
Light Siam Satin (227 SATIN)				■				
Light Siam Shimmer (227 SHIM)		■	■	■	■			
Light Siam Shimmer 2x (227 SHIM2)		■	■					
Light Smoked Topaz AB (221 AB)				■				
Light Topaz AB (226 AB)				■				
Light Topaz Aurore Boreale 2x (226 AB2)				■				
Light Topaz Shimmer (226 SHIM)		■	■	■	■			
Light Topaz Shimmer 2x (226 SHIM2)		■	■					
Majestic Blue AB (296 AB)		■	■	■	■			
Majestic Blue Aurore Boreale 2x (296 AB2)		■	■					
Montana AB (207 AB)		■	■					
Montana Aurore Boreale 2x (207 AB2)				■				
Olivine AB (228 AB)		■	■					
Pacific Opal Aurore Boreale 2x (390 AB2)				■				
Pacific Opal Shimmer (390 SHIM)		■	■	■	■			
Pacific Opal Shimmer 2x (390 SHIM2)		■	■					
Peridot AB (214 AB)				■				
Peridot Aurore Boreale 2x (214 AB2)				■				
Peridot Shimmer (214 SHIM)		■	■	■	■			
Peridot Shimmer 2x (214 SHIM2)		■	■					
Purple Velvet AB (277 AB)				■				
Rose AB (209 AB)		■	■	■	■			
Rose Aurore Boreale 2x (209 AB2)				■				
Rose Peach Shimmer (262 SHIM)		■	■	■	■			
Rose Peach Shimmer 2x (262 SHIM2)		■	■					
Rose Satin (209 SATIN)				■				

5328

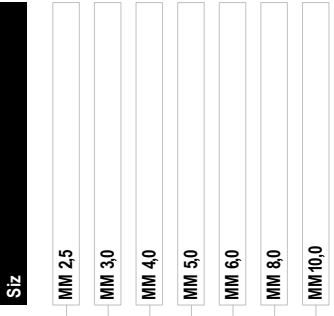

- Rose Shimmer (209 SHIM)
- Rose Shimmer 2x (209 SHIM2)
- Rose Water Opal Aurore Boreale 2x (395 AB)
- Rose Water Opal Shimmer (395 SHIM)
- Rose Water Opal Shimmer 2x (395 SHIM2)
- Ruby AB (501 AB)
- Sapphire AB (206 AB)
- Sapphire Aurore Boreale 2x (206 AB2)
- Scarlet AB (276 AB)
- Scarlet Aurore Boreale 2x (276 AB2)
- Siam AB (208 AB)
- Siam Aurore Boreale 2x (208 AB2)
- Siam Shimmer (208 SHIM)
- Siam Shimmer 2x (208 SHIM2)
- Smoked Topaz AB (220 AB)
- Smoky Mauve AB (265 AB)
- Smoky Mauve Aurore Boreale 2x (265 AB2)
- Tanzanite AB (539 AB)
- Tanzanite Aurore Boreale 2x (539 AB2)
- Topaz AB (203 AB)
- Topaz Aurore Boreale 2x (203 AB2)
- Turquoise AB (267 AB)
- Turquoise Aurore Boreale 2x (267 AB2)
- Violet AB (371 AB)
- Violet Aurore Boreale 2x (371 AB2)
- White Alabaster Aurore Boreale 2x (281 AB2)
- White Opal AB (234 AB)
- White Opal Aurore Boreale 2x (234 AB2)
- White Opal Shimmer (234 SHIM)
- White Opal Shimmer 2x (234 SHIM2)
- Yellow Opal AB (231 AB)
- Yellow Opal Aurore Boreale 2x (231 AB2)
- Yellow Opal Shimmer (231 SHIM)
- Yellow Opal Shimmer 2x (231 SHIM2)
- Jet Hematite (280 HEM)

5328

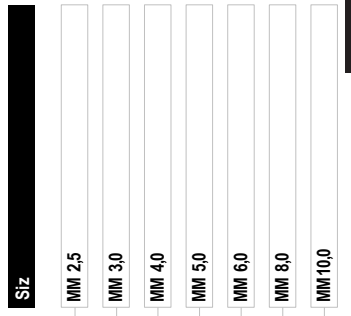

- Jet Hematite 2x (280 HEM2)

5378 Cross Bead

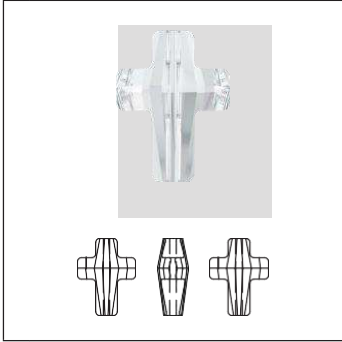

Siz	MM 14,0	MM 18,0
-----	---------	---------

- Crystal**
- Crystal (001)
- Colors**
- Plain Colors**
- Jet (280)
- Crystal Effects**
- Transparent Effects**
- Crystal AB (001 AB)
- Crystal Golden Shadow (001 GSHA)
- Crystal Paradise Shine (001 PARSH)
- Crystal Silver Night (001 SINI)
- Crystal Patina**
- Crystal Silver Patina (001 SILPA)

5500

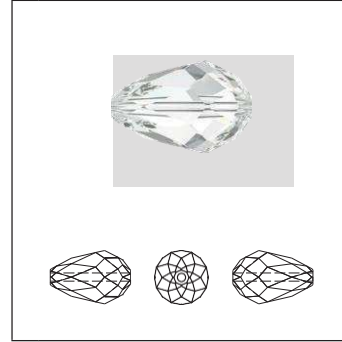

Siz	MM 9,0X 6,0	MM 12,0X 8,0
-----	-------------	--------------

- Crystal**
- Crystal (001)
- Colors**
- Plain Colors**
- Amethyst (204)
- Aquamarine (202)
- Jet (280)
- Light Colorado Topaz (246)
- Light Rose (223)
- Light Siam (227)
- Siam (208)
- Crystal Effects**
- Transparent Effects**
- Crystal AB (001 AB)
- Crystal Shimmer 2x (001 SHIM2)
- Color Effects**
- Amethyst Shimmer 2x (204 SHIM2)
- Aquamarine Shimmer 2x (202 SHIM2)
- Light Colorado Topaz Shimmer 2x (246 SHIM2)
- Light Siam Shimmer 2x (227 SHIM2)

5514 Pendulum Bead

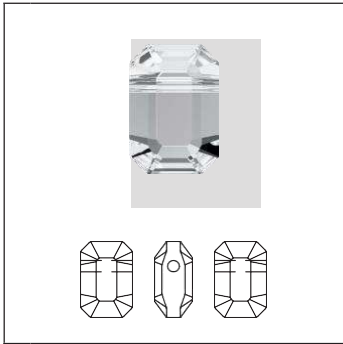

Siz	MM 8,0X 5,5	MM 10,0X 7,0
-----	-------------	--------------

- Crystal**
- Crystal (001)
- Colors**
- Plain Colors
- Emerald (205)
- Jet (280)
- Crystal Effects**
- Transparent Effects
- Crystal AB (001 AB)
- Crystal Silver Night (001 SINI)
- Metallic Effects**
- Crystal Metallic Sunshine (001 METSH)

5515 Emerald Cut Bead

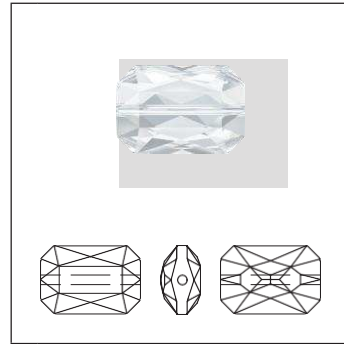

Siz	MM 14,0X 9,5	MM 18,0X 12,5
-----	--------------	---------------

- Crystal**
- Crystal (001)
- Colors**
- Plain Colors
- Amethyst (204)
- Aquamarine (202)
- Blush Rose (257)
- Emerald (205)
- Jet (280)
- Crystal Effects**
- Transparent Effects
- Crystal Golden Shadow (001 GSHA)

5523 CosmicBead

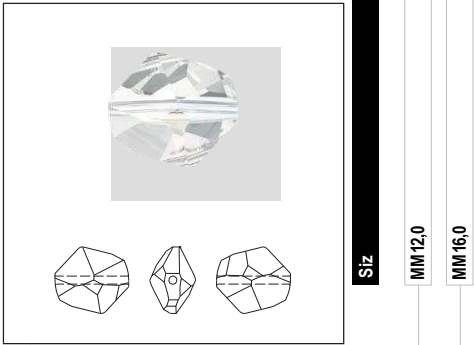

Siz

MM 12,0

MM 16,0

- Crystal**
- Crystal (001)
- Crystal Effects**
- Transparent Effects**
- Crystal AB (001 AB)
- Crystal Golden Shadow (001 GSHA)

5540 ArtemisBead

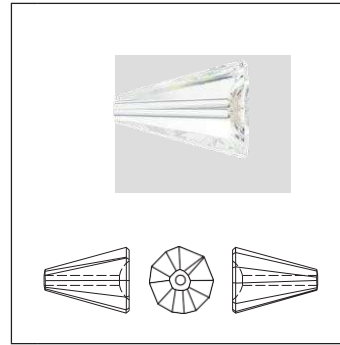

Siz

MM 12,0

MM 17,0

- Crystal**
- Crystal (001)
- Colors**
- Plain Colors**
- Amethyst (204)
- Aquamarine (202)
- Crystal Effects**
- Transparent Effects**
- Crystal AB (001 AB)
- Crystal Golden Shadow (001 GSHA)

5541 DomeBeadlarge

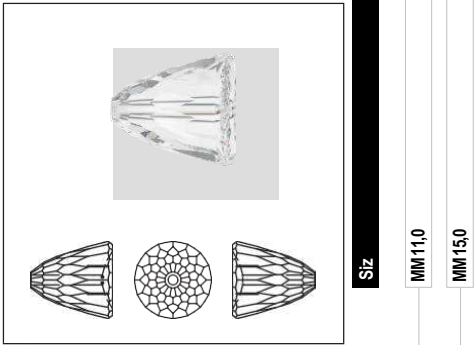

Siz

MM 11,0

MM 15,0

- Crystal**
- Crystal (001)
- Colors**
- Plain Colors**
- Smoky Mauve (265)
- Crystal Effects**
- Transparent Effects**
- Crystal AB (001 AB)
- Crystal Golden Shadow (001 GSHA)
- Crystal Paradise Shine (001 PARSH)

5542 DomeBeadsmall

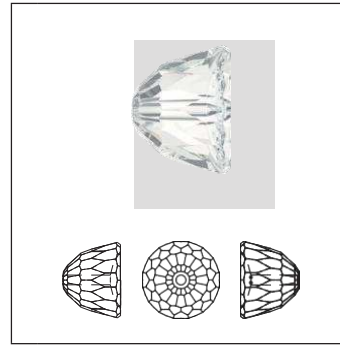

Siz

MM 8,0

MM 11,0

- Crystal**
- Crystal (001)
- Crystal Effects**
- Transparent Effects**
- Crystal AB (001 AB)
- Crystal Golden Shadow (001 GSHA)

5601

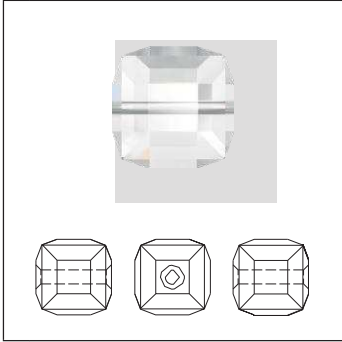

Siz	MM 4,0	MM 6,0	MM 8,0	MM 10,0	MM 12,0
-----	--------	--------	--------	---------	---------

Crystal

Crystal (001)	■	■	■	■	■
Crystal Rose Gold B2x (001 ROGB2)	■	■			

Colors

Plain Colors

Amethyst (204)	■	■	■		
Aquamarine (202)	■	■	■		
Black Diamond (215)	■	■	■		
Blush Rose (257)	■	■	■		
Emerald (205)	■	■	■		
Erinite (360)	■	■	■		
Fuchsia (502)		■	■		
Iris (219)	■	■	■		
Jet (280)	■	■	■		
Light Colorado Topaz (246)	■	■	■		
Light Sapphire (211)	■	■	■		
Light Siam (227)	■	■	■		
Light Topaz (226)		■	■		
Light Turquoise (263)	■	■	■		
Majestic Blue (296)	■	■			
Peridot (214)	■	■	■		
Rose Peach (262)	■	■	■		
Sapphire (206)	■	■	■		
Siam (208)	■	■	■		
Tanzanite (539)	■	■	■		
Topaz (203)	■	■	■		

Crystal Effects

Transparent Effects

Crystal Aurore Boreale B (001 ABB)	■	■	■	■	■
Crystal Blue Shade 'B' (001 BLSB)	■	■	■		
Crystal Golden Shadow 'B' (001 GSHAB)	■	■	■		
Crystal Shimmer B (001 SHIMB)	■	■	■		
Crystal Silver Night 'B' (001 SINIB)	■	■	■		
Crystal Vitrail Medium B (001 VMB)	■	■	■		

Metallic Effects

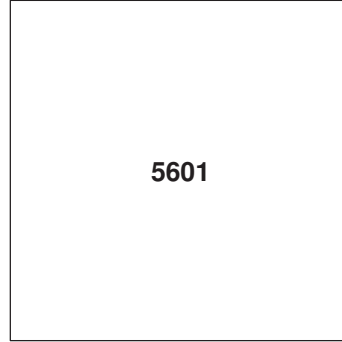

Siz	MM 4,0	MM 6,0	MM 8,0	MM 10,0	MM 12,0
-----	--------	--------	--------	---------	---------

Crystal Light Chrome B (001 LTCHB)	■	■	■		
Crystal Metallic Sunshine B (001 MTSHB)	■	■	■		
Crystal Rose Gold 'B' (001 ROGLB)	■	■			

Color Effects

Black Diamond Shimmer B (215 SHIMB)	■	■	■		
Chrysolite Opal Shimmer B (294 SHIMB)	■	■			
Erinite Shimmer B (360 SHIMB)	■	■	■		
Light Colorado Topaz Shimmer B (246 SHIMB)	■	■	■		
Light Sapphire Shimmer B (211 SHIMB)	■	■	■		
Light Siam Shimmer B (227 SHIMB)	■	■	■		
Pacific Opal Shimmer B (390 SHIMB)	■	■			
Rose Peach Shimmer B (262 SHIMB)	■	■	■		
Rose Water Opal Shimmer B (395 SHIMB)	■	■			
White Opal Shimmer B (234 SHIMB)	■	■			

5621 Twist Bead

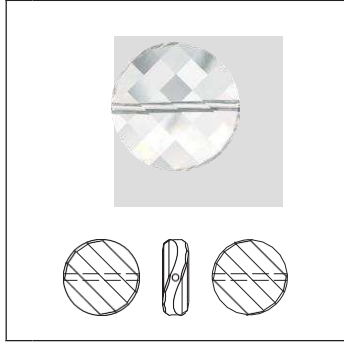

Siz	MM 14,0	MM 18,0

Crystal

Crystal (001)

Colors

Plain Colors

Amethyst (204)

Aquamarine (202)

Crystal Effects

Transparent Effects

Crystal Golden Shadow (001 GSHA)

5624 Stairway Bead

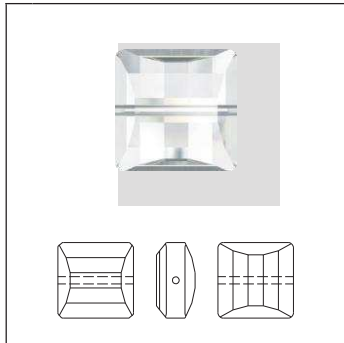

Siz	MM 10,0	MM 14,0

Crystal

Crystal (001)

Crystal Effects

Transparent Effects

Crystal AB (001 AB)

Crystal Golden Shadow (001 GSHA)

5714 StarBead

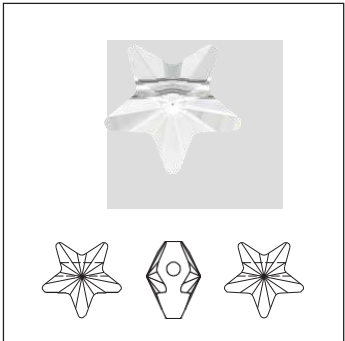

Siz

MM 8,0

MM 12,0

Crystal

Crystal (001)

Crystal Effects

Transparent Effects

Crystal AB (001 AB)

Crystal Golden Shadow (001 GSHA)

5727 FishBead

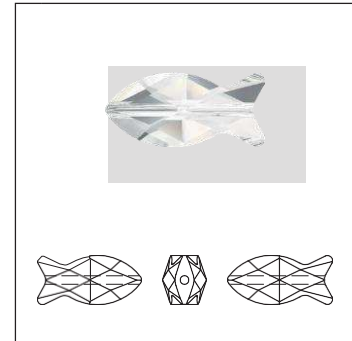

Siz

MM 14,0

Crystal

Crystal (001)

Crystal Effects

Transparent Effects

Crystal AB (001 AB)

Crystal Golden Shadow (001 GSHA)

5728 ScarabBead

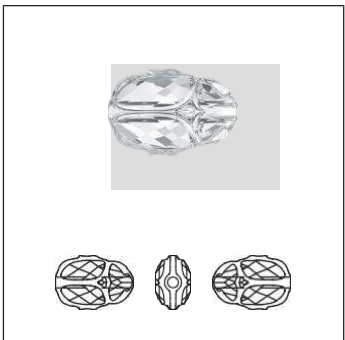

Siz

MM 12,0

Crystal

Crystal (001)

Colors

Plain Colors

Amethyst (204)

Aquamarine (202)

Emerald (205)

Jet (280)

Crystal Effects

Transparent Effects

Crystal AB (001 AB)

Crystal Golden Shadow (001 GSHA)

Crystal Silver Night (001 SINI)

Metallic Effects

Crystal Metallic Sunshine (001 METSH)

Crystal Scarabaeus Green (001 SCGR)

Crystal Scarabaeus Green 2x (001 SCGR2)

5741 LoveBead

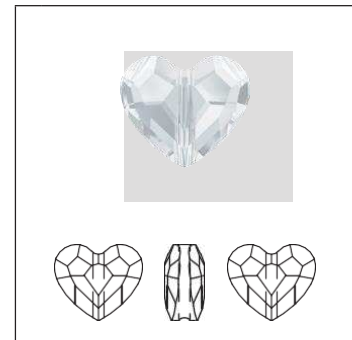

Siz

MM 8,0

MM 12,0

Crystal

Crystal (001)

Colors

Plain Colors

Blush Rose (257)

Light Siam (227)

Crystal Effects

Transparent Effects

Crystal AB (001 AB)

Crystal Silver Night 2x (001 SINI2)

*** designed by Jean Paul Gaultier

5742 Heart Bead

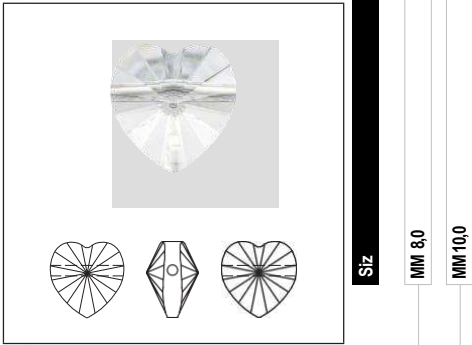

- Crystal**
- Crystal (001)
- Crystal Effects**
- Transparent Effects
- Crystal AB (001 AB)
- Crystal Golden Shadow (001 GSHA)

5744 Flower Bead

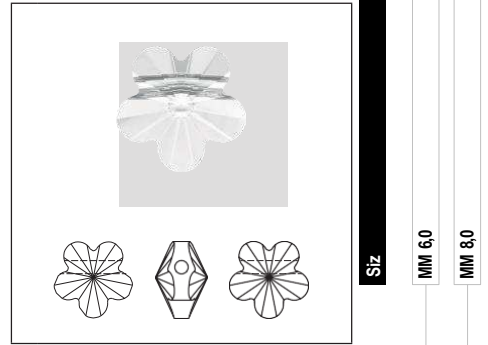

- Crystal**
- Crystal (001)
- Crystal Effects**
- Transparent Effects
- Crystal AB (001 AB)

5747 Double Spike Bead

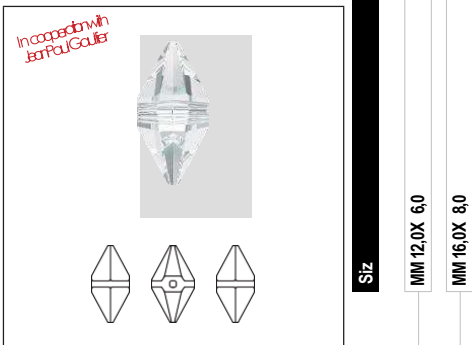

- Crystal**
- Crystal (001)
- Colors**
- Plain Colors
- Jet (280)
- Crystal Effects**
- Transparent Effects
- Crystal AB (001 AB)
- Crystal Golden Shadow (001 GSHA)
- Crystal Lilac Shadow (001 LISH)
- Crystal Silver Night (001 SINI)
- Crystal Silver Shade (001 SSHA)
- Metallic Effects**
- Crystal Metallic Blue 2x (001 MEBL2)

5750 Skull Bead

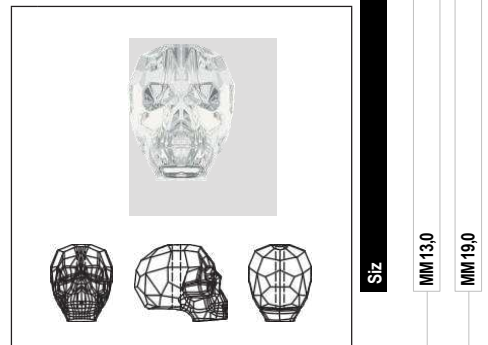

- Crystal**
- Crystal (001)
- Colors**
- Plain Colors
- Denim Blue (266)
- Jet (280)
- Crystal Effects**
- Transparent Effects
- Crystal AB (001 AB)
- Crystal Golden Shadow (001 GSHA)
- Crystal Paradise Shine (001 PARSH)
- Crystal Red Magma (001 REDM)
- Crystal Silver Night (001 SINI)
- Crystal Silver Night 2x (001 SINI2)
- Metallic Effects**
- Crystal Iridescent Green (001 IRIG)
- Crystal Light Chrome (001 LTCH)
- Crystal Light Chrome 2x (001 LTCH2)
- Crystal Metallic Blue 2x (001 MEBL2)
- Crystal Metallic Sunshine (001 METSH)
- Crystal MetallicLightGold 2x (001 MLG2)
- Crystal Rose Gold 2x (001 ROGL2)

5752 CloverBead

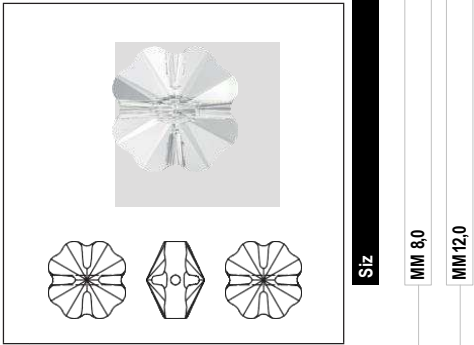

Siz

MM 8,0

MM 12,0

Crystal

Crystal (001)

Colors

Plain Colors

Light Siam (227)

Peridot (214)

Crystal Effects

Transparent Effects

Crystal AB (001 AB)

Crystal Golden Shadow (001 GSHA)

5754 ButterflyBead

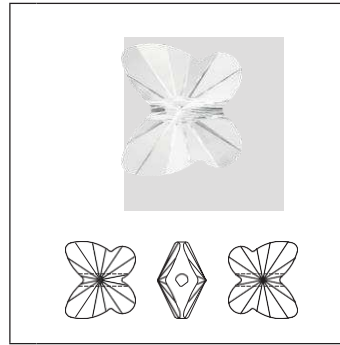

Siz

MM 6,0

MM 8,0

MM 10,0

MM 12,0

Crystal

Crystal (001)

Colors

Plain Colors

Aquamarine (202)

Fuchsia (502)

Jet (280)

Jonquil (213)

Light Rose (223)

Light Siam (227)

Peridot (214)

Violet (371)

Crystal Effects

Transparent Effects

Crystal AB (001 AB)

Crystal Golden Shadow (001 GSHA)

Crystal Paradise Shine (001 PARSH)

5928 BECHARMED HELIX BEAD



Siz
MM 14,0 STEEL

Crystal

Crystal STEEL (001)

Colors

Plain Colors

Amethyst STEEL (204)

Aquamarine STEEL (202)

Chrysolite STEEL (238)

Emerald STEEL (205)

Fern Green STEEL (291)

Indicolite STEEL (379)

Jet STEEL (280)

Light Smoked Topaz STEEL (221)

Light Topaz STEEL (226)

Montana STEEL (207)

Rose STEEL (209)

Sapphire STEEL (206)

Violet STEEL (371)

Opal Colors

White Opal STEEL (234)

Crystal Effects

Transparent Effects

Crystal AB STEEL (001 AB)

Crystal Golden Shadow STEEL (001 GSHA)

Crystal Red Magma STEEL (001 REDM)

5928 BECHARMED HELIX BEAD



Siz
MM 14,0 STEEL

Crystal

Crystal STEEL (001)

Colors

Plain Colors

Amethyst STEEL (204)

Aquamarine STEEL (202)

Jet STEEL (280)

Light Smoked Topaz STEEL (221)

Peridot STEEL (214)

Rose STEEL (209)

Crystal Effects

Transparent Effects

Crystal AB STEEL (001 AB)

Crystal Golden Shadow STEEL (001 GSHA)

5948 BECHARMED BROLETTE BEAD



Siz
MM 14,0 STEEL

Crystal

Crystal STEEL (001)

Colors

Plain Colors

Amethyst STEEL (204)

Aquamarine STEEL (202)

Chrysolite STEEL (238)

Emerald STEEL (205)

Fern Green STEEL (291)

Indicolite STEEL (379)

Jet STEEL (280)

Light Smoked Topaz STEEL (221)

Light Topaz STEEL (226)

Montana STEEL (207)

Rose STEEL (209)

Sapphire STEEL (206)

Violet STEEL (371)

Opal Colors

White Opal STEEL (234)

Crystal Effects

Transparent Effects

Crystal AB STEEL (001 AB)

Crystal Golden Shadow STEEL (001 GSHA)

Crystal Red Magma STEEL (001 REDM)

FINE ROCKS TUBE

5950 Fine Rocks Tube with ending

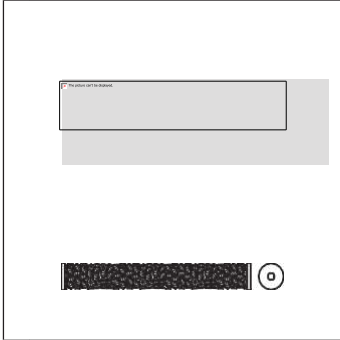

5951 Fine Rocks Tube without ending

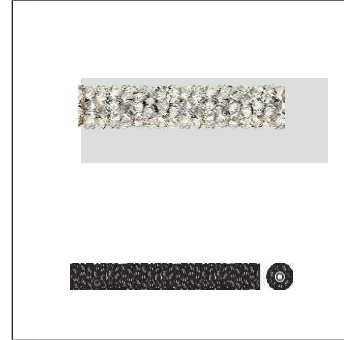

Overview of all available Colors of Metal Parts



081 Gold Coating



088 Stainless Steel

Important Notice

This component is expertly crafted and should be treated with special care, as it has a rough surface that may come into contact with skin or delicate fabrics when incorporated into other products.

Do not bend it nor remove its end caps during further processing in order to avoid any damage to the component.

Care Instructions



Turn inside out and use mild laundry detergent (wash by hand, max. temp. 30°C, very mild process).



Do not use chlorine bleach!



Do not tumble dry!



Do not iron!

COMPLEMENTARY PRODUCTS

These protective plastic spacer rings are recommended for use between Beads, increasing the durability of the designs and enabling the use of larger Beads and more complex cuts.

Please order art. 7800 Nr. 646 with Sys.no. 977980 (**packing unit = 100 pcs**) and art. 7800 Nr. 647 with Sys.no. 977981 (**packing unit = 1,000 pcs**).

7800 Protective Spacer Rings

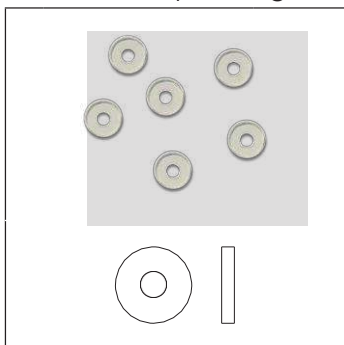

C Transparent

S 3 mm (hole 1 mm)

M 100 PCS (Nr. 646)
1,000 PCS (Nr. 647)

150%

PRODUCT DETAILS

Article Size	Packing Unit = Minimum Order Quantity in Pieces	Average Net Weight in Gram per Packing Unit Crystal (001)	Average Gross Weight in Gram per Packing Unit Crystal (001)
5000			
2 mm	1,440	11.5	20.8
3 mm	720	23.6	33.4
4 mm	720	53.5	62.6
5 mm	720	105.3	116.3
6 mm	360	81.6	92.5
7 mm	288	126.2	159.2
8 mm	288	193.5	200.8
10 mm	144	180.6	199.4
12 mm	72	144.2	166.1
14 mm	72	247.1	280.5
5003			
6 mm	360	109.9	120.8
8 mm	144	100.4	118.6
10 mm	144	195.9	219.2
12 mm	72	158.5	179.2
14 mm	48	172.4	193.0
5005			
8 mm	216	145.4	172.1
12 mm	72	154.3	175.4
16 mm	24	122.1	146.7
5020			
6 mm	360	74.5	85.2
8 mm	288	146.6	178.2
10 mm	144	116.4	139.2
5028/4			
6 mm	360	75.791	83.4
8 mm	144	74.714	85.6
10 mm	72	70.763	76.5
5040			
4 mm	720	41.3	50.4
6 mm	360	71.8	82.9
8 mm	288	135.6	163.7
12 mm	144	214.4	242.4
5041			
18 mm	24	114.2	133.0
5045			
6 mm	288	60.7	70.9
8 mm	216	117.5	145.9
5058			
10 mm	72	37.1	57.3
14 mm	36	50.4	71.0
5060			
5.5 mm	288	49.40	62.92
7.5 mm	144	48.82	72.67
5061			
5.5 mm	288	62.65	75.50
7.5 mm	144	46.37	71.85

Article Size	Packing Unit = Minimum Order Quantity in Pieces	Average Net Weight in Gram per Packing Unit Crystal (001)	Average Gross Weight in Gram per Packing Unit Crystal (001)
5062			
5.5 mm	288	50.85	67.95
7.5 mm	144	40.32	62.16
5200			
6x4 mm	360	44.1	53.2
7.5x5 mm	360	80.0	91.0
5305			
5 mm	720	52.7	63.9
6 mm	360	50.5	61.4
5328			
2.5 mm	1,440	23.8	31.4
3 mm	1,440	34.1	45.2
4 mm	1,440	81.8	89.2
5 mm	720	89.3	100.0
6 mm	360	73.7	84.6
8 mm	288	141.8	173.4
10 mm	144	140.4	154.0
5378			
14 mm	72	55.6	83.87
18 mm	48	81.7	103.06
5500			
9x6 mm	144	59.0	69.9
12x8 mm	144	144.0	164.1
5514			
8x5.5 mm	144	72.7	67.8
10x7 mm	96	48.9	70.7
5515			
14x9.5 mm	36	36.3	56.5
18x12.5 mm	24	52.1	74.2
5523			
12 mm	144	143.2	173.6
16 mm	72	156.1	194.7
5540			
12 mm	72	62.1	86.7
17 mm	48	108.9	133.5
5541			
11 mm	96	105.6	129.3
15 mm	48	126.2	146.2
5542			
8 mm	96	81.4	102.9
11 mm	48	97.6	118.6
5601			
4 mm	288	43.9	65.2
6 mm	144	70.6	88.9
8 mm	96	100.2	118.4
10 mm	72	138.0	156.5
12 mm	36	129.6	147.7

Article Size	Packing Unit = Minimum Order Quantity in Pieces	Average Net Weight in Gram per Packing Unit Crystal (001)	Average Gross Weight in Gram per Packing Unit Crystal (001)
5621			
14 mm	96	168.7	202.1
18 mm	72	253.1	283.8
5624			
10 mm	108	117.51	134.2
14 mm	72	174.77	204.5
5714			
8 mm	288	73.3	102.1
12 mm	108	72.3	102.2
5727			
14 mm	108	72.3	105.4
5728			
12 mm	96	59.5	85.1
5741			
8 mm	144	43.3	66.24
12 mm	72	66.2	89.58
5742			
8 mm	288	120.5	154.5
10 mm	288	233.1	266.5
5744			
6 mm	360	47.4	58.1
8 mm	288	80.2	112.3
5747			
12x6 mm	144	64.4	81.2
16x8 mm	96	104.8	124.4
5750			
13 mm	12	24.2	43.8
19 mm	12	73.7	100.0
5752			
8 mm	288	106.1	136.9
12 mm	96	117.7	137.5
5754			
6 mm	360	42.3	53.0
8 mm	288	77.9	109.8
10 mm	288	156.9	188.9
12 mm	144	136.7	168.9
5950			
15 mm	10	12.00	12.01
30 mm	10	18.60	18.61
5951			
15 mm	10	6.80	6.81
30 mm	10	13.90	13.91
7800			
Nr. 646	100	-	-
Nr. 647	1,000	-	-



CRYSTAL PEARLS

Crystal Pearls are perfect replicas from genuine pearls. They are made of a unique crystal core covered with an innovative pearl coating, producing a flawless, silky smooth, rounded surface. They are available in a variety of shapes, sizes, and colors. Different hole diameters are available to accommodate a range of

applications: art. 5811 Crystal Pearl (large hole), art. 5840 Crystal Baroque Pearl, and art. 5860 Crystal Coin Pearl are perfectly suited to applications that require a larger hole diameter. Crystal Pearls offer unlimited combination possibilities with the colorful loose crystal elements assortment.

NUMERICAL ORDER

001 160	Crystal Mauve Pearl
001 294	Crystal Rosaline Pearl
001 295	Crystal Bronze Pearl
001 296	Crystal Gold Pearl
001 298	Crystal Black Pearl
001 300	Crystal Peach Pearl
001 301	Crystal Burgundy Pearl
001 302	Crystal Light Blue Pearl
001 305	Crystal Powder Almond Pearl
001 306	Crystal Bright Gold Pearl
001 335	Crystal Mystic Black Pearl
001 352	Crystal Powder Rose Pearl
001 459	Crystal Platinum Pearl
001 524	Crystal Lavender Pearl
001 538	Crystal Bordeaux Pearl
001 539	Crystal Light Gold Pearl
001 616	Crystal Light Grey Pearl
001 617	Crystal Dark Grey Pearl
001 618	Crystal Light Creamrose Pearl
001 620	Crystal Cream Pearl
001 621	Crystal Creamrose Pearl
001 650	Crystal White Pearl
001 651	Crystal Vintage Gold Pearl
001 674	Crystal Rose Peach Pearl
001 708	Crystal Ivory Pearl
001 709	Crystal Turquoise Pearl
001 715	Crystal Jade Pearl
001 716	Crystal Pink Coral Pearl
001 718	Crystal Red Coral Pearl
001 719	Crystal Dark Lapis Pearl
001 731	Crystal Grey Pearl
001 732	Crystal Neon Pink Pearl ¹
001 733	Crystal Neon Orange Pearl ¹
001 734	Crystal Neon Yellow Pearl ¹
001 769	Crystal Rose Gold Pearl
001 770	Crystal Neon Red Pearl ¹
001 771	Crystal Neon Green Pearl ¹
001 816	Crystal Coral Pearl
001 818	Crystal Night Blue Pearl
001 930	Crystal Iridescent Green Pearl
001 944	Crystal Pastel Rose Pearl
001 943	Crystal Iridescent Purple Pearl
001 945	Crystal Pastel Yellow Pearl
001 946	Crystal Scarabaeus Green*** Pearl
001 947	Crystal Iridescent Red Pearl
001 949	Crystal Iridescent Dark Blue Pearl
001 948	Crystal Iridescent Light Blue Pearl
001 951	Crystal Velvet Brown Pearl
001 954	Crystal Iridescent Dove Grey Pearl
001 966	Crystal Pastel Blue Pearl
001 967	Crystal Pastel Green Pearl
001 968	Crystal Pastel Grey Pearl
001 969	Crystal Pearlescent White Pearl
001 2004	Crystal Iridescent Tahitian Look Pearl

ALPHABETICAL ORDER

Crystal Black Pearl (001 298)
Crystal Bordeaux Pearl (001 538)
Crystal Bright Gold Pearl (001 306)
Crystal Bronze Pearl (001 295)
Crystal Burgundy Pearl (001 301)
Crystal Coral Pearl (001 816)
Crystal Cream Pearl (001 620)
Crystal Creamrose Pearl (001 621)
Crystal Dark Grey Pearl (001 617)
Crystal Dark Lapis Pearl (001 719)
Crystal Gold Pearl (001 296)
Crystal Grey Pearl (001 731)
Crystal Iridescent Dark Blue Pearl (001 949)
Crystal Iridescent Dove Grey Pearl (001 954)
Crystal Iridescent Green Pearl (001 930)
Crystal Iridescent Light Blue Pearl (001 948)
Crystal Iridescent Purple Pearl (001 943)
Crystal Iridescent Red Pearl (001 947)
Crystal Iridescent Tahitian Look Pearl (001 2004)
Crystal Ivory Pearl (001 708)
Crystal Jade Pearl (001 715)
Crystal Lavender Pearl (001 524)
Crystal Light Blue Pearl (001 302)
Crystal Light Creamrose Pearl (001 618)
Crystal Light Gold Pearl (001 539)
Crystal Light Grey Pearl (001 616)
Crystal Mauve Pearl (001 160)
Crystal Mystic Black Pearl (001 335)
Crystal Neon Green Pearl (001 771) ¹
Crystal Neon Orange Pearl (001 733) ¹
Crystal Neon Pink Pearl (001 732) ¹
Crystal Neon Red Pearl (001 770) ¹
Crystal Neon Yellow Pearl (001 734) ¹
Crystal Night Blue Pearl (001 818)
Crystal Pastel Blue Pearl (001 966)
Crystal Pastel Green Pearl (001 967)
Crystal Pastel Grey Pearl (001 968)
Crystal Pastel Rose Pearl (001 944)
Crystal Pastel Yellow Pearl (001 945)
Crystal Peach Pearl (001 300)
Crystal Pearlescent White Pearl (001 969)
Crystal Pink Coral Pearl (001 716)
Crystal Platinum Pearl (001 459)
Crystal Powder Almond Pearl (001 305)
Crystal Powder Rose Pearl (001 352)
Crystal Red Coral Pearl (001 718)
Crystal Rosaline Pearl (001 294)
Crystal Rose Gold Pearl (001 769)
Crystal Rose Peach Pearl (001 674)
Crystal Scarabaeus Green*** Pearl (001 946)
Crystal Turquoise Pearl (001 709)
Crystal Velvet Brown Pearl (001 951)
Crystal Vintage Gold Pearl (001 651)
Crystal White Pearl (001 650)

*** designed by Jean Paul Gaultier

¹ Please note that due to technical print limitations, the color references of Crystal Pearl Neon Colors do not correspond to the true luminescent appearance of the real article.

Colors and effects can appear different when illuminated with different light sources. Swarovski uses standard light source D50 for color decision and comparison.



Communication on Product-Assortment changes*

IMPORTANT INFORMATION ON ASSORTMENT ADJUSTMENTS



We would kindly like to inform you about overall portfolio streamlining as well as discontinuations of selected product lines, effective as of November 23rd, 2020.

In order to allow you sufficient time to prepare, upcoming changes are already visible in our B2B e-commerce platform. During this transition phase the collection has been marked with the following caption:

Caption - SUMMARY

	OUT OF ASSORTMENT
	CHANGES IN THE ASSORTMENT
	NO CHANGES IN THE ASSORTMENT

Caption - MATRIX

	OUT OF ASSORTMENT
	FUTURE MADE TO ORDER ITEM - MTO
	FUTURE MADE TO STOCK ITEM - MTS

SUMMARY

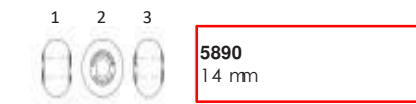
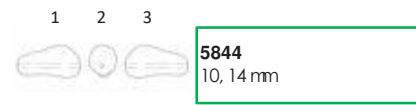
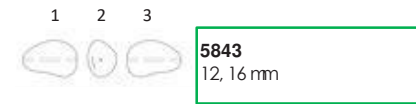
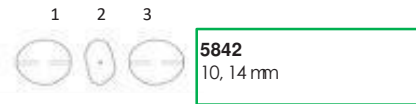
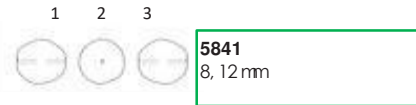
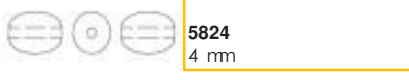
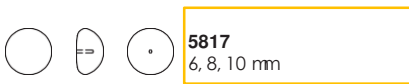
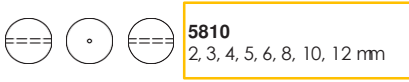
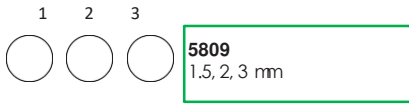

ORDERING EXAMPLE & PRODUCT VARIETY EXPLANATION

5810 Crystal Round Pearl

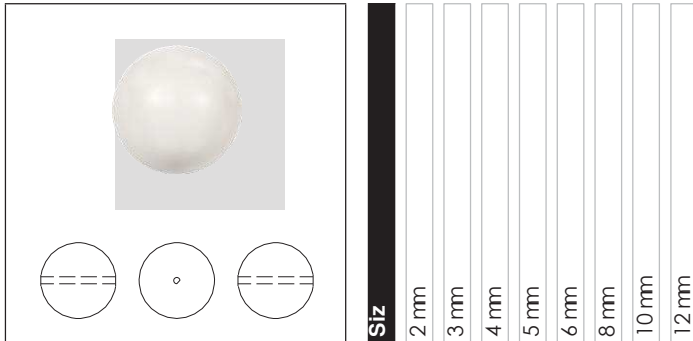

5810	2 mm	001 650
------	------	---------

Article number

Crystal Pearl size

Color

All sizes are
subject to special orders.

Desired Crystal Pearl colorcode

Please see respective product matrix for all
available reference codes.

As a general guideline for customers
Crystal Pearls bigger than 5 mm should
be knotted on strings. Pearls below
5 mm should be unknotted.

5809 Crystal NoHole Pearl

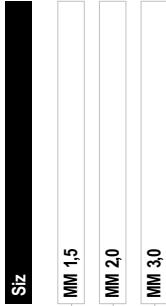
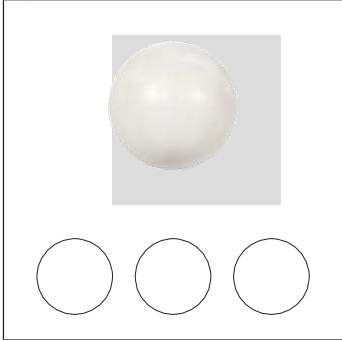

Colors

- Crystal Cream Pearl (001 620)
 - Crystal Light Grey Pearl (001 616)
 - Crystal Rose Gold Pearl (001 769)
 - Crystal White Pearl (001 650)
- Gem Colors**
- Crystal Mystic Black Pearl (001 335)

5810 Crystal Round Pearl

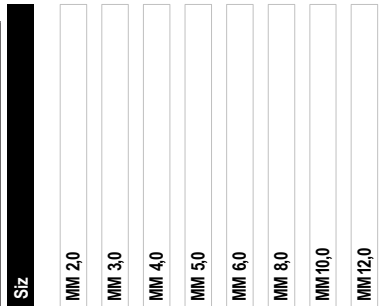
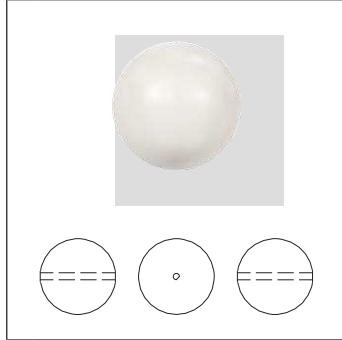

Crystal

- Crystal Pastel Blue Pearl (001 966)
- Crystal Pastel Green Pearl (001 967)
- Crystal Pastel Grey Pearl (001 968)
- Crystal Pastel Rose Pearl (001 944)
- Crystal Pastel Yellow Pearl (001 945)

Colors

- Crystal Black Pearl (001 298)
- Crystal Bordeaux Pearl (001 538)
- Crystal Bright Gold Pearl (001 306)
- Crystal Bronze Pearl (001 295)
- Crystal Burgundy Pearl (001 301)
- Crystal Cream Pearl (001 620)
- Crystal Creamrose Lt. Pearl (001 618)
- Crystal Creamrose Pearl (001 621)
- Crystal Dark Grey Pearl (001 617)
- Crystal Eden Green Pearl (001 2014)
- Crystal Elderberry PRL (001 2019)
- Crystal Gold Pearl (001 296)
- Crystal Grey Pearl (001 731)
- Crystal Irid Dreamy Blue PRL (001 2026)
- Crystal Irid Dreamy Rose PRL (001 2025)
- Crystal Irid Tahit Look PRL (001 2004)
- Crystal Irides. Dk Blue PRL (001 949)
- Crystal Irides. Dv Grey PRL (001 954)
- Crystal Irides. Lt Blue PRL (001 948)
- Crystal Iridescent Green PRL (001 930)
- Crystal Iridescent Purple Pr (001 943)
- Crystal Iridescent Red PRL (001 947)
- Crystal Lavender Pearl (001 524)
- Crystal Light Blue Pearl (001 302)
- Crystal Light Gold Pearl (001 539)
- Crystal Light Grey Pearl (001 616)
- Crystal Mauve Pearl (001 160)
- Crystal Mulberry Pink PRL (001 2018)

5810

Siz	MM 2,0	MM 3,0	MM 4,0	MM 5,0	MM 6,0	MM 8,0	MM 10,0	MM 12,0
-----	--------	--------	--------	--------	--------	--------	---------	---------

Crystal Night Blue Pearl (001 818)	■	■	■	■	■	■	■	■
Crystal Peach Pearl (001 300)	■	■	■	■	■	■	■	■
Crystal Pearlescent White PR (001 969)	■	■	■	■	■	■	■	■
Crystal Platinum Pearl (001 459)	■	■	■	■	■	■	■	■
Crystal Powder Almond Pearl (001 305)	■	■	■	■	■	■	■	■
Crystal Powder Rose Pearl (001 352)	■	■	■	■	■	■	■	■
Crystal Rosaline Pearl (001 294)	■	■	■	■	■	■	■	■
Crystal Rose Gold Pearl (001 769)	■	■	■	■	■	■	■	■
Crystal Rose Peach Pearl (001 674)	■	■	■	■	■	■	■	■
Crystal Scarabaeus Green PRL (001 946)	■	■	■	■	■	■	■	■
Crystal Velvet Brown Pearl (001 951)	■	■	■	■	■	■	■	■
Crystal Vintage Gold Pearl (001 651)	■	■	■	■	■	■	■	■
Crystal White Pearl (001 650)	■	■	■	■	■	■	■	■
Gem Colors								
Crystal Ivory Pearl (001 708)	■	■	■	■	■	■	■	■
Crystal Coral Pearl (001 816)	■	■	■	■	■	■	■	■
Crystal Dark Lapis Pearl (001 719)	■	■	■	■	■	■	■	■
Crystal Jade Pearl (001 715)	■	■	■	■	■	■	■	■
Crystal Mystic Black Pearl (001 335)	■	■	■	■	■	■	■	■
Crystal Pink Coral Pearl (001 716)	■	■	■	■	■	■	■	■
Crystal Red Coral Pearl (001 718)	■	■	■	■	■	■	■	■
Neon Colors								
Crystal Neon Green Pearl (001 771)	■	■	■	■	■	■	■	■
Crystal Neon Orange Pearl (001 733)	■	■	■	■	■	■	■	■
Crystal Neon Pink Pearl (001 732)	■	■	■	■	■	■	■	■
Crystal Neon Red Pearl (001 770)	■	■	■	■	■	■	■	■
Crystal Neon Yellow Pearl (001 734)	■	■	■	■	■	■	■	■

5811 Crystal Pearl (large hole)

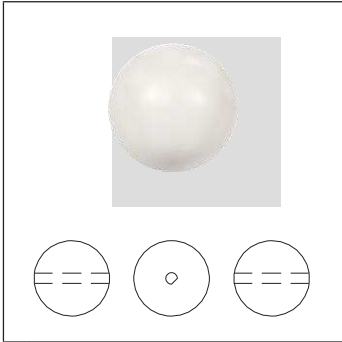

Siz	MM10,0	MM12,0	MM14,0
-----	--------	--------	--------

Colors

Crystal Black Pearl (001 298)	■	■	■
Crystal Bright Gold Pearl (001 306)	■	■	■
Crystal Bronze Pearl (001 295)	■	■	■
Crystal Cream Pearl (001 620)	■	■	■
Crystal Creamrose Lt. Pearl (001 618)	■	■	■
Crystal Creamrose Pearl (001 621)	■	■	■
Crystal Dark Grey Pearl (001 617)	■	■	■
Crystal Gold Pearl (001 296)	■	■	■
Crystal Grey Pearl (001 731)	■	■	■
Crystal Iridescent Green PRL (001 930)	■	■	■
Crystal Iridescent Purple Pr (001 943)	■	■	■
Crystal Light Grey Pearl (001 616)	■	■	■
Crystal Mauve Pearl (001 160)	■	■	■
Crystal Night Blue Pearl (001 818)	■	■	■
Crystal Pearlescent White PR (001 969)	■	■	■
Crystal Platinum Pearl (001 459)	■	■	■
Crystal Powder Rose Pearl (001 352)	■	■	■
Crystal Rosaline Pearl (001 294)	■	■	■
Crystal Rose Gold Pearl (001 769)	■	■	■
Crystal Scarabaeus Green PRL (001 946)	■	■	■
Crystal White Pearl (001 650)	■	■	■

Gem Colors

Crystal Mystic Black Pearl (001 335)	■	■	■
--------------------------------------	---	---	---

5816

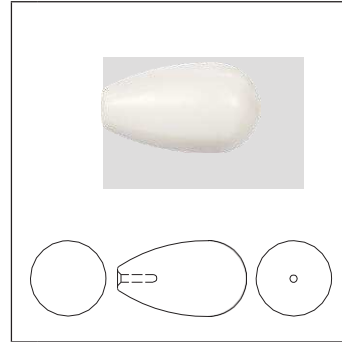

Siz	MM11,5X 6,0	MM15,0X 8,0
-----	-------------	-------------

Colors

Crystal Black Pearl (001 298)	■	■
Crystal Bronze Pearl (001 295)	■	■
Crystal Cream Pearl (001 620)	■	■
Crystal Creamrose Lt. Pearl (001 618)	■	■
Crystal Creamrose Pearl (001 621)	■	■
Crystal Dark Grey Pearl (001 617)	■	■
Crystal Grey Pearl (001 731)	■	■
Crystal Iridescent Green PRL (001 930)	■	■
Crystal Light Gold Pearl (001 539)	■	■
Crystal Light Grey Pearl (001 616)	■	■
Crystal Mauve Pearl (001 160)	■	■
Crystal Rosaline Pearl (001 294)	■	■
Crystal Rose Gold Pearl (001 769)	■	■
Crystal White Pearl (001 650)	■	■

Gem Colors

Crystal Mystic Black Pearl (001 335)	■	■
--------------------------------------	---	---

5817

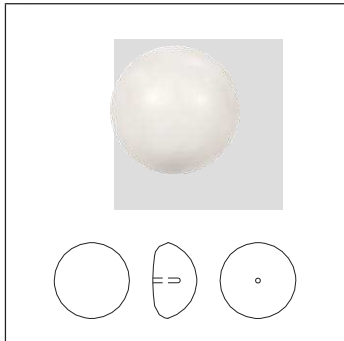

Siz	MM 6,0	MM 8,0	MM 10,0
-----	--------	--------	---------

Crystal

Crystal Pastel Blue Pearl (001 966)	■	■	■
Crystal Pastel Green Pearl (001 967)	■	■	■
Crystal Pastel Grey Pearl (001 968)	■	■	■
Crystal Pastel Rose Pearl (001 944)	■	■	■
Crystal Pastel Yellow Pearl (001 945)	■	■	■

Colors

Crystal Bronze Pearl (001 295)	■	■	■
Crystal Cream Pearl (001 620)	■	■	■
Crystal Creamrose Lt. Pearl (001 618)	■	■	■
Crystal Creamrose Pearl (001 621)	■	■	■
Crystal Dark Grey Pearl (001 617)	■	■	■
Crystal Eden Green Pearl (001 2014)	■	■	
Crystal Elderberry PRL (001 2019)	■	■	
Crystal Irid Dreamy Blue PRL (001 2026)	■	■	
Crystal Irid Dreamy Rose PRL (001 2025)	■	■	
Crystal Irid Tahit Look PRL (001 2004)	■	■	
Crystal Iridesc. Dk Blue PRL (001 949)	■	■	
Crystal Iridesc. Dv Grey PRL (001 954)	■	■	■
Crystal Iridesc. Lt Blue PRL (001 948)	■	■	
Crystal Iridescent Green PRL (001 930)	■	■	■
Crystal Iridescent Purple Pr (001 943)	■	■	■
Crystal Iridescent Red PRL (001 947)	■	■	
Crystal Light Grey Pearl (001 616)	■	■	■
Crystal Mulberry Pink PRL (001 2018)	■	■	
Crystal Peach Pearl (001 300)	■	■	■
Crystal Pearlescent White PR (001 969)	■	■	■
Crystal Rosaline Pearl (001 294)	■	■	■
Crystal Rose Gold Pearl (001 769)	■	■	■
Crystal Scarabaeus Green PRL (001 946)	■	■	■
Crystal Velvet Brown Pearl (001 951)	■	■	
Crystal White Pearl (001 650)	■	■	■

5818

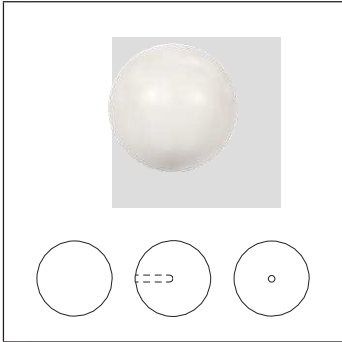

Siz	MM 3,0	MM 4,0	MM 5,0	MM 6,0	MM 8,0	MM 10,0	MM 12,0
-----	--------	--------	--------	--------	--------	---------	---------

Crystal

Crystal Pastel Blue Pearl (001 966)	■	■		■	■	■	
Crystal Pastel Green Pearl (001 967)	■	■		■	■	■	
Crystal Pastel Grey Pearl (001 968)	■	■		■	■	■	
Crystal Pastel Rose Pearl (001 944)	■	■		■	■	■	
Crystal Pastel Yellow Pearl (001 945)	■	■		■	■	■	

Colors

Crystal Black Pearl (001 298)				■	■	■	■
Crystal Cream Pearl (001 620)	■	■	■	■	■	■	■
Crystal Creamrose Lt. Pearl (001 618)	■			■	■	■	■
Crystal Creamrose Pearl (001 621)	■	■	■	■	■	■	■
Crystal Dark Grey Pearl (001 617)	■			■	■	■	■
Crystal Eden Green Pearl (001 2014)				■	■	■	■
Crystal Elderberry PRL (001 2019)				■	■	■	
Crystal Grey Pearl (001 731)				■	■	■	■
Crystal Irid Dreamy Blue PRL (001 2026)				■	■	■	
Crystal Irid Dreamy Rose PRL (001 2025)				■	■	■	
Crystal Irid Tahit Look PRL (001 2004)				■	■	■	■
Crystal Iridesc. Dk Blue PRL (001 949)				■	■	■	
Crystal Iridesc. Dv Grey PRL (001 954)	■	■		■	■	■	■
Crystal Iridesc. Lt Blue PRL (001 948)				■	■	■	
Crystal Iridescent Green PRL (001 930)				■	■	■	■
Crystal Iridescent Purple Pr (001 943)		■		■	■	■	■
Crystal Iridescent Red PRL (001 947)				■	■	■	■
Crystal Lavender Pearl (001 524)				■	■	■	■
Crystal Light Gold Pearl (001 539)				■	■	■	■
Crystal Light Grey Pearl (001 616)				■	■	■	■
Crystal Mulberry Pink PRL (001 2018)				■	■	■	
Crystal Peach Pearl (001 300)				■	■	■	■
Crystal Pearlescent White PR (001 969)	■	■		■	■	■	
Crystal Platinum Pearl (001 459)				■	■	■	■
Crystal Rosaline Pearl (001 294)	■	■	■	■	■	■	■
Crystal Rose Gold Pearl (001 769)				■	■	■	■
Crystal Scarabaeus Green PRL (001 946)	■	■	■	■	■	■	■
Crystal Velvet Brown Pearl (001 951)				■	■	■	

*** designed by Jean Paul Gaultier

5818

Siz	MM 3,0	MM 4,0	MM 5,0	MM 6,0	MM 8,0	MM 10,0	MM 12,0
Crystal White Pearl (001 650)	■	■	■	■	■	■	■
Gem Colors							
Crystal Ivory Pearl (001 708)			■	■	■	■	■
Crystal Coral Pearl (001 816)			■	■	■	■	■
Crystal Dark Lapis Pearl (001 719)			■	■	■	■	■
Crystal Jade Pearl (001 715)			■	■	■	■	■
Crystal Mystic Black Pearl (001 335)	■	■	■	■	■	■	■
Crystal Pink Coral Pearl (001 716)			■	■	■	■	■
Crystal Red Coral Pearl (001 718)			■	■	■	■	■
Crystal Turquoise Pearl (001 709)					■	■	■

5821 Crystal Pearshaped Pearl

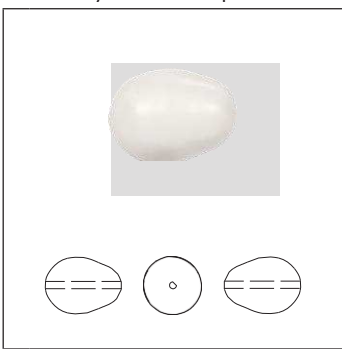

Siz	MM 11,0X 8,0
Crystal Bronze Pearl (001 295)	■
Crystal Cream Pearl (001 620)	■
Crystal Creamrose Lt. Pearl (001 618)	■
Crystal Creamrose Pearl (001 621)	■
Crystal Iridescent Green PRL (001 930)	■
Crystal Iridescent Purple Pr (001 943)	■
Crystal Light Grey Pearl (001 616)	■
Crystal Rosaline Pearl (001 294)	■
Crystal Rose Peach Pearl (001 674)	■
Crystal White Pearl (001 650)	■
Gem Colors	
Crystal Mystic Black Pearl (001 335)	■

5824 CRYSTAL RICESHAPE PEARL



Siz

MM 4,0

Colors

- Crystal Cream Pearl (001 620)
 - Crystal Dark Grey Pearl (001 617)
 - Crystal Elderberry PRL (001 2019)
 - Crystal Gold Pearl (001 296)
 - Crystal Irid Dreamy Blue PRL (001 2026)
 - Crystal Irid Dreamy Rose PRL (001 2025)
 - Crystal Irid Tahit Look PRL (001 2004)
 - Crystal Light Gold Pearl (001 539)
 - Crystal Mulberry Pink PRL (001 2018)
 - Crystal Rosaline Pearl (001 294)
 - Crystal White Pearl (001 650)
- Gem Colors
- Crystal Mystic Black Pearl (001 335)

5840 Crystal Baroque Pearl

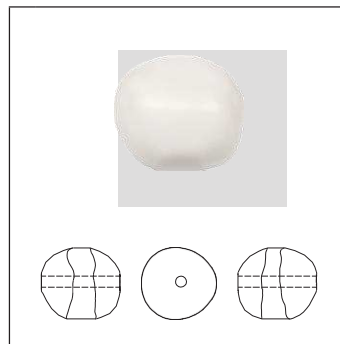

Siz

MM 6,0

MM 8,0

MM 10,0

MM 12,0

Colors

- Crystal Cream Pearl (001 620)
- Crystal Creamrose Lt. Pearl (001 618)
- Crystal Creamrose Pearl (001 621)
- Crystal Dark Grey Pearl (001 617)
- Crystal Irid Tahit Look PRL (001 2004)
- Crystal Iridescent Green PRL (001 930)
- Crystal Iridescent Purple Pr (001 943)
- Crystal Light Grey Pearl (001 616)
- Crystal Rosaline Pearl (001 294)
- Crystal Rose Gold Pearl (001 769)
- Crystal Scarabaeus Green PRL (001 946)
- Crystal White Pearl (001 650)

5841 CRYSTAL RICESHAPE PEARL



Siz
MM 8,0
MM 12,0

Colors

- Crystal Cream Pearl (001 620)
- Crystal Dark Grey Pearl (001 617)
- Crystal Irid Tahit Look PRL (001 2004)
- Crystal Light Grey Pearl (001 616)
- Crystal Rosaline Pearl (001 294)
- Crystal White Pearl (001 650)

5842 CRYSTAL BAROQUE COIN PEARL



Siz
MM 10,0
MM 14,0

Colors

- Crystal Cream Pearl (001 620)
- Crystal Dark Grey Pearl (001 617)
- Crystal Irid Tahit Look PRL (001 2004)
- Crystal Light Grey Pearl (001 616)
- Crystal Rosaline Pearl (001 294)
- Crystal White Pearl (001 650)

5843 CRYSTAL BAROQUE DROP PEARL



Siz
MM 12,0
MM 16,0

Colors

- Crystal Cream Pearl (001 620)
- Crystal Dark Grey Pearl (001 617)
- Crystal Irid Tahit Look PRL (001 2004)
- Crystal Light Grey Pearl (001 616)
- Crystal Rosaline Pearl (001 294)
- Crystal White Pearl (001 650)

5844 CRYSTAL BAROQUE ELONGATED PEARL



Siz
MM 10,0
MM 14,0

Colors

- Crystal Cream Pearl (001 620)
- Crystal Dark Grey Pearl (001 617)
- Crystal Irid Tahit Look PRL (001 2004)
- Crystal Light Grey Pearl (001 616)
- Crystal Rosaline Pearl (001 294)
- Crystal White Pearl (001 650)

5860 Crystal Coin Pearl

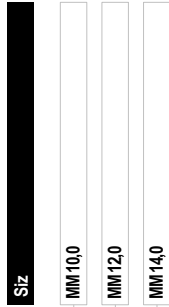
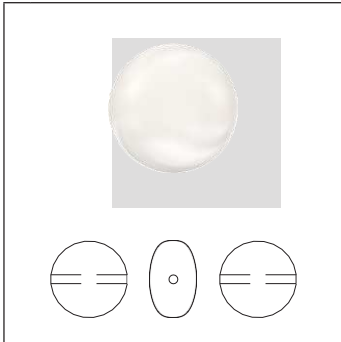

Colors

Crystal Black Pearl (001 298)	■	■	■
Crystal Cream Pearl (001 620)	■	■	■
Crystal Eden Green Pearl (001 2014)	■	■	
Crystal Elderberry PRL (001 2019)	■	■	
Crystal Irid Dreamy Blue PRL (001 2026)	■	■	
Crystal Irid Dreamy Rose PRL (001 2025)	■	■	
Crystal Irid Tahit Look PRL (001 2004)	■	■	
Crystal Iridesc. Dk Blue PRL (001 949)	■	■	
Crystal Iridesc. Dv Grey PRL (001 954)	■	■	
Crystal Iridesc. Lt Blue PRL (001 948)	■	■	
Crystal Iridescent Green PRL (001 930)	■	■	■
Crystal Iridescent Purple Pr (001 943)	■	■	■
Crystal Iridescent Red PRL (001 947)	■	■	■
Crystal Light Gold Pearl (001 539)	■	■	■
Crystal Mulberry Pink PRL (001 2018)	■	■	
Crystal Pearlescent White PR (001 969)	■	■	
Crystal Platinum Pearl (001 459)	■	■	■
Crystal Rose Gold Pearl (001 769)	■	■	■
Crystal Scarabaeus Green PRL (001 946)	■	■	
Crystal Velvet Brown Pearl (001 951)	■	■	
Crystal White Pearl (001 650)	■	■	■

5890 CRYSTAL BECHARMED PEARL



Colors

Crystal Black Pearl STEEL (001 298)	■
Crystal Bronze Pearl STEEL (001 295)	■
Crystal Gold Pearl STEEL (001 296)	■
Crystal Grey Pearl STEEL (001 731)	■
Crystal Iridesc. Dk Blue PRL STEEL (001 949)	■
Crystal Iridesc. Lt Blue PRL STEEL (001 948)	■
Crystal Iridescent Green PRL STEEL (001 93)	■
Crystal Iridescent Purple Pr STEEL (001 943)	■
Crystal Iridescent Red PRL STEEL (001 947)	■
Crystal Lavender Pearl STEEL (001 524)	■
Crystal Pearlescent White PR STEEL (001 96)	■
Crystal Platinum Pearl STEEL (001 459)	■
Crystal Rosaline Pearl STEEL (001 294)	■
Crystal Rose Peach Pearl STEEL (001 674)	■
Crystal White Pearl STEEL (001 650)	■

CRYSTAL PEARL BOW METAL PART

58M001 Metal Bow

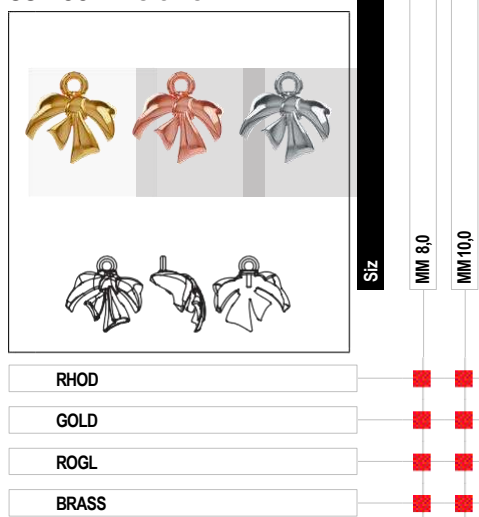
**Application Advice**

This metal cap can be glued onto Crystal Pearls (art. 5810, art. 5818) or Beads (art. 5003, art. 5028) using an adhesive such as the Swarovski Crystal Glue CG 500 (A+B). Please follow the whole gluing process (i.e. cleaning, mixing, dosing, setting, curing) carefully. When the glue is dispensed onto the metal part, make sure that the entire surface of the pin and the base part is covered with the adhesive.

For detailed information about gluing, please refer to the Application Manual and our business website SWAROVSKI-PROFESSIONAL.COM

Care Instructions

Do not wash!



Do not use chlorine bleach!



Do not tumble dry!



Do not iron!



The textile may not be dry cleaned.

PRODUCT DETAILS

Article Size	Packing Unit = Minimum Order Quantity in Pieces	Average Net Weight in Gram per Packing Unit Crystal (001)	Average Gross Weight in Gram per Packing Unit Crystal (001)
5809			
1.5 mm	2,000	8.5	18.8
2 mm	1,500	20.4	30.4
3 mm	1,000	36.6	46.4
5810			
2 mm	1,000	10.2	23.3
3 mm	1,000	38.5	53.5
4 mm	500	38.1	53.6
5 mm	500	83.7	99.2
6 mm	500	142.3	157.8
8 mm	250	173.7	188.9
10 mm	100	110.5	123.9
12 mm	100	191.7	205.1
5811			
10 mm	100	110.5	123.9
12 mm	100	191.7	205.1
14 mm	50	152.8	166.1
5816			
11.5x6 mm	100	71.0	81.9
15x8 mm	100	117.2	128.1
5817			
6 mm	250	35.8	49.3
8 mm	250	97.9	111.2
10 mm	250	195.6	203.9
5818			
3 mm	1,000	42.0	52.0
4 mm	500	41.9	55.4
5 mm	500	87.9	101.4
6 mm	500	146.5	160.0
8 mm	250	177.9	191.1
10 mm	100	112.2	125.6
12 mm	100	187.5	200.9
5821			
11x8 mm	250	238.5	253.5
5840			
6 mm	500	125.5	139.1
8 mm	250	150.7	165.7
10 mm	100	128.9	140.8
12 mm	100	213.4	224.2
5860			
10 mm	100	90.3	101.6
12 mm	100	153.6	164.9
14 mm	50	242.7	253.9
58M001			
8 mm	12	3.48	22.0
10 mm	12	5.88	24.0



PENDANTS

Pendants have timeless elegance and are available in a large range of classical and avant-garde cuts and shapes, as well as many colors and effects. Pendants offer a whole range of design possibilities for different segments thanks to their easy



application, with the top hole requiring only a jumping/pinch bail with a chain or cord. Due to the diverse range of sizes available, Pendants are ideal for creating jewelry sets such as necklaces, bracelets, and earrings.



Communication on Product-Assortment changes*

IMPORTANT INFORMATION ON ASSORTMENT ADJUSTMENTS





































We would kindly like to inform you about overall portfolio streamlining as well as discontinuations of selected product lines, effective as of November 23rd, 2020.

In order to allow you sufficient time to prepare, upcoming changes are already visible in our B2B e-commerce platform. During this transition phase the collection has been marked with the following caption:

Caption - SUMMARY	
	OUT OF ASSORTMENT
	CHANGES IN THE ASSORTMENT
	NO CHANGES IN THE ASSORTMENT

Caption - MATRIX	
	OUT OF ASSORTMENT
	FUTURE MADE TO ORDER ITEM - MTO
	FUTURE MADE TO STOCK ITEM - MTS

SUMMARY

1 2 3 	6000 11x5.5, 13x6.5, 15x7.5, 22x11 mm	1 2 3 	6040 20, 30, 40 mm	1 2 3 	COREASSORTMENT 6228 10.3x10, 14.4x14, 18x17.5, 28, 40 mm
	6002 10x7, 15x11.5 mm		6041 18, 28, 38 mm		6240 12, 17, 27 mm
	6007 7x4, 9x5 mm		6049 20, 30 mm		DESIGNER EDITION 6261 17, 27, 36 mm
	COREASSORTMENT 6010 11x5.5, 13x6.5, 17x8.5, 21x10.5 mm		6090 16x11, 22x15 mm		DESIGNER EDITION 6262 17, 26, 34 mm
	6012 11x10, 15.4x14 mm		6100 24x12 mm		DESIGNER EDITION 6264 18, 28 mm
	6015 17, 21, 50 mm		COREASSORTMENT 6106 16, 22, 28, 38 mm		6320 14, 19, 27 mm
	DESIGNER EDITION 6017/G 30, 56 mm		6128 8, 10, 12 mm		6328 6, 8 mm
	6020 18, 30, 37 mm		6150 30 mm		6401 8, 12 mm
	6022 14, 24 mm		6210 12, 17 mm		COREASSORTMENT 6428 6, 8, 12 mm
	6028 8, 10, 12, 18 mm		6215 18 mm		6430 8, 10, 14 mm
	6039 25, 38 mm		6225 10, 18, 28 mm		6460 20 mm
	6431 9, 11.5, 16 mm		6432 8, 10.5, 14.5 mm		6433 9, 11.5, 16 mm
	6435 9, 11.5, 16 mm				

1 Front view 2 Side view 3 Back view

"1 Front view" or "3 Back view" shaded in gray: surface effect is applied to this side.

"2 Side view" shaded in gray: side of surface effect not defined (for all symmetrical and some asymmetrical articles).

Where all views are shaded in gray, the effect is applied over the entire marked surface.

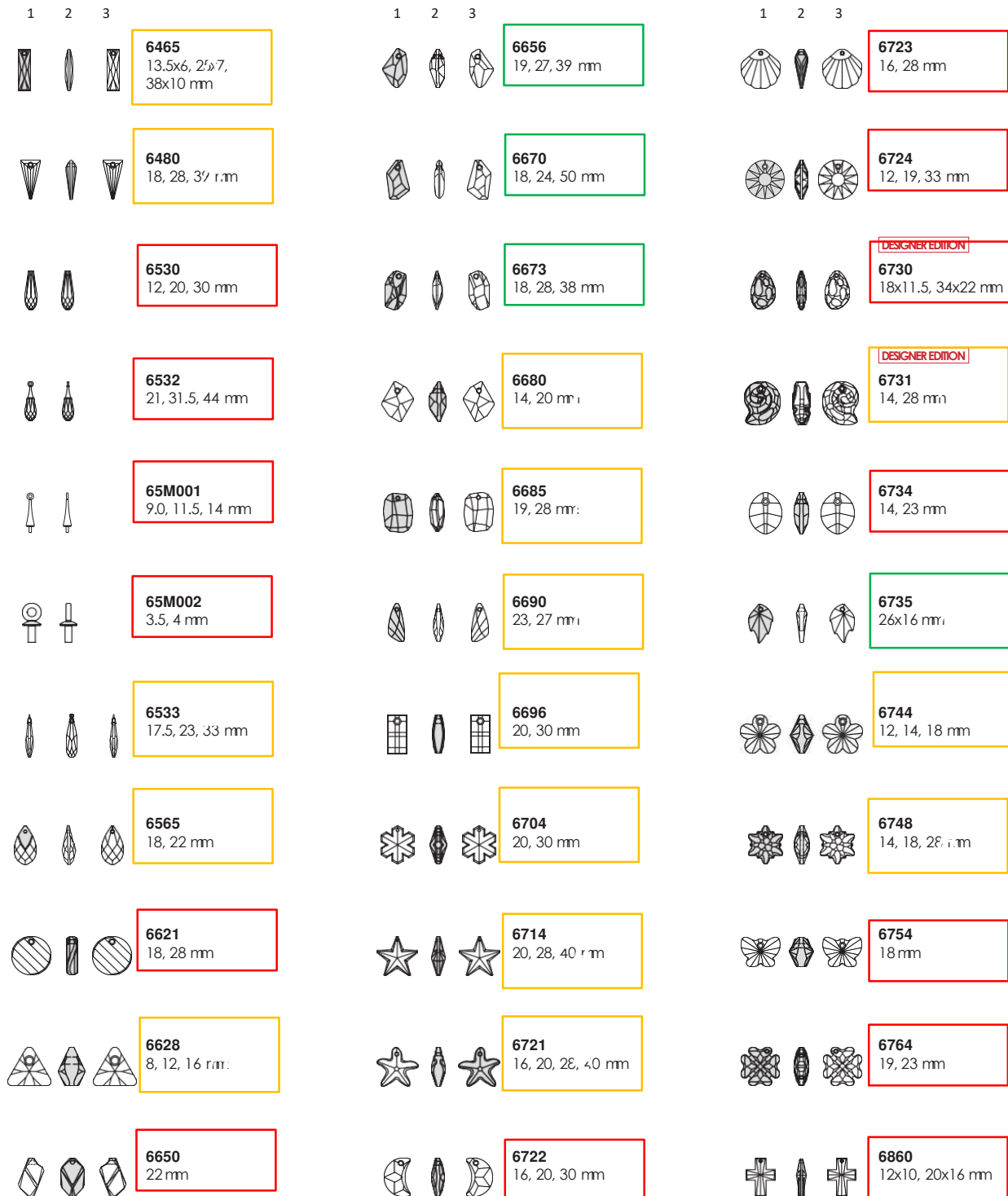

1 Front view 2 Side view 3 Back view

"1 Front view" or "3 Back view" shaded in gray: the surface effect is applied to this side.

"2 Side view" shaded in gray: side of surface effect not defined (for all symmetrical and some asymmetrical articles).

6721: 16, 20 mm: no defined side for surface effect; 28, 40 mm surface effect on "3 Back view."

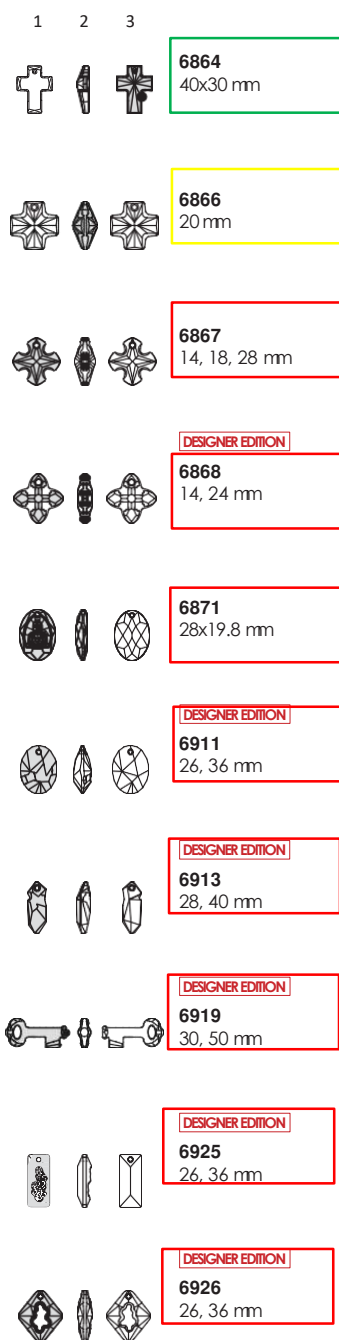

1 Front view 2 Side view 3 Back view

"1 Front view" or "3 Back view" shaded in gray: the surface effect is applied to this side.

"2 Side view" shaded in gray: side of surface effect not defined (for all symmetrical and some asymmetrical articles).

Where all views are shaded in gray, the effect is applied over the entire marked surface.

6864: Reverse effect "V" is the standard version and is therefore shaded.

6000



Siz	MM 11,0X 5,5	MM 13,0X 6,5	MM 15,0X 7,5	MM 22,0X 11,0
-----	--------------	--------------	--------------	---------------

Crystal

Crystal (001)	■	■	■	■
---------------	---	---	---	---

Colors

Plain Colors

Amethyst (204)	■			
Aquamarine (202)	■			
Emerald (205)	■			
Jet (280)	■	■	■	
Light Siam (227)	■			
Majestic Blue (296)	■			
Rose (209)	■			
Sapphire (206)	■			
Scarlet (276)	■			
Siam (208)	■	■	■	
Tanzanite (539)	■			
Topaz (203)	■			

Crystal Effects

Transparent Effects

Crystal AB (001 AB)	■	■	■	■
Crystal Paradise Shine (001 PARSH)	■			

6002

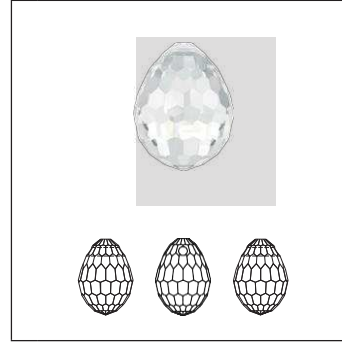

Siz	MM 10,0X 7,0	MM 15,0X 11,5
-----	--------------	---------------

Crystal

Crystal (001)	■	■
---------------	---	---

Crystal Effects

Transparent Effects

Crystal AB (001 AB)	■	■
---------------------	---	---

6007 Small Briolette Pendant

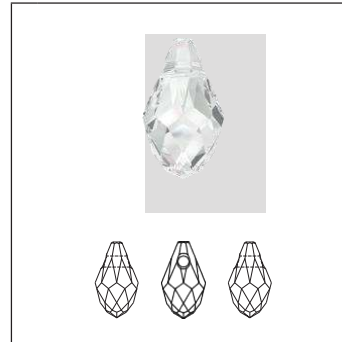

Siz	MM 7,0X 4,0	MM 9,0X 5,0
-----	-------------	-------------

Crystal

Crystal (001)	■	■
---------------	---	---

Crystal Effects

Transparent Effects

Crystal AB (001 AB)	■	■
Crystal Golden Shadow (001 GSXA)	■	■

CORE ASSORTMENT

6010 Briolette Pendant

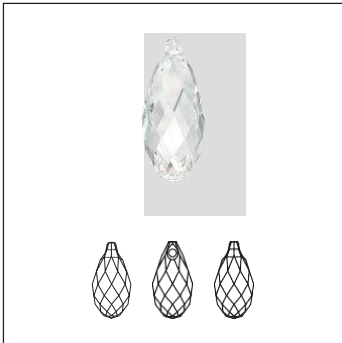

Siz	MM 11,0X 5,5	MM 13,0X 6,5	MM 17,0X 8,5	MM 21,0X 10,5
-----	--------------	--------------	--------------	---------------

Crystal

Crystal (001)	■	■	■	■
---------------	---	---	---	---

Colors

Plain Colors

Amethyst (204)	■	■	■	
Aquamarine (202)	■	■	■	
Denim Blue (266)	■	■	■	
Emerald (205)	■	■	■	
Erinite (360)	■	■	■	
Fuchsia (502)	■	■	■	
Graphite (253)	■	■	■	
Iris (219)	■	■	■	
Jet (280)	■	■	■	
Light Amethyst (212)	■	■	■	
Light Colorado Topaz (246)	■	■	■	
Light Rose (223)	■	■	■	
Light Turquoise (263)	■	■	■	
Padparadscha (542)	■	■	■	
Rose Peach (262)	■	■	■	
Scarlet (276)	■	■	■	
Siam (208)	■	■	■	
Tanzanite (539)	■	■	■	

Opal Colors

Chrysolite Opal (294)	■	■	■	
Yellow Opal (231)	■	■	■	

Crystal Effects

Transparent Effects

Crystal Antique Pink (001 ANTP)	■	■	■	
Crystal AB (001 AB)	■	■	■	■
Crystal Blue Shade (001 BLSH)	■	■	■	
Crystal Golden Shadow (001 GSHA)	■	■	■	■
Crystal Lilac Shadow (001 LISH)	■	■	■	
Crystal Luminous Green (001 LUMG)	■	■	■	
Crystal Paradise Shine (001 PARSH)	■	■	■	
Crystal Silver Night (001 SINI)	■	■	■	
Crystal Silver Shade (001 SSHA)	■	■	■	

6012 Flat Briolette Pendant

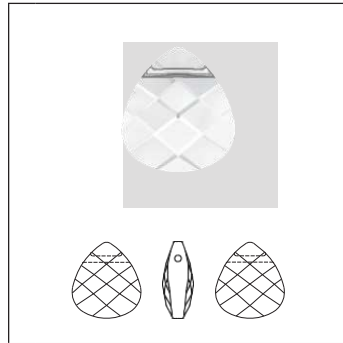

Siz	MM 11,0X 10,0	MM 15,4X 14,0
-----	---------------	---------------

Crystal

Crystal (001)	■	■
---------------	---	---

Colors

Plain Colors

Aquamarine (202)	■	■
------------------	---	---

Crystal Effects

Transparent Effects

Crystal AB (001 AB)	■	■
Crystal Golden Shadow (001 GSHA)	■	■

6015 Polygon Drop



Siz	MM 17,0	MM 21,0	MM 50,0
-----	---------	---------	---------

Crystal

Crystal (001)	■	■	■
---------------	---	---	---

Crystal Effects

Transparent Effects

Crystal AB (001 AB)	■	■	
Crystal Golden Shadow (001 GSHA)	■	■	

MAISON MARGIELA FOR SWAROVSKI

DESIGNER EDITION

CRYSTALACTITE PENDANTS

Since 1988, Paris-based Maison Margiela has become famous for its collaborative team-led approach and its avant-garde transformation of classic designs. In July 2013, it presented the *Maison Margiela Crystalactite for Swarovski* at its Paris Haute Couture show. These were groundbreaking Crystal Fusion components inspired by natural stalactite forms and developed in creative partnership with Swarovski. Now Swarovski presents its interpretation of this innovative cut in pure crystal – the *Crystalactite Pendant*. Featuring a progressive aesthetic combining partly frosted facets with primeval, irregular icicle shapes, the

vision that originated in our wildest landscapes has now been perfected by one of the most sophisticated design houses. With an easy-to-use hole at the top, the Pendant offers myriad design possibilities for strong, contemporary designs, and for recreating haute-couture looks.

“Naturally and spontaneously, an imposing crystal emerges from its raw, stony origin, patiently growing into its iconic stalactite shape.”

6017/G Crystalactite Pendant grand partly frosted

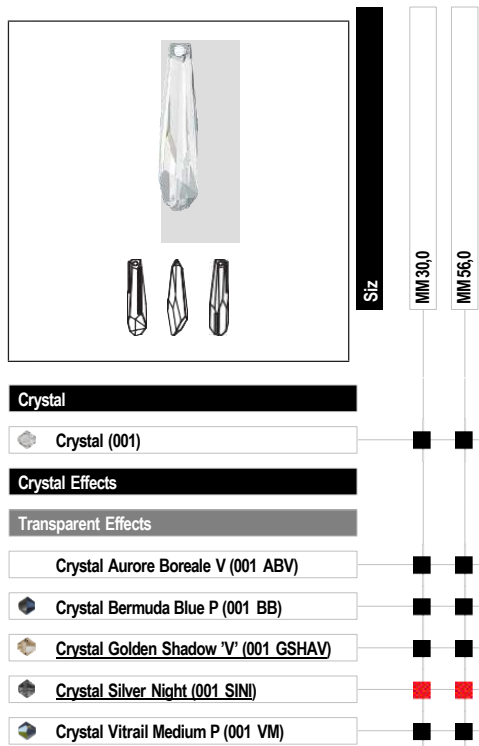

6020 Helix Pendant



Crystal		MM 18,0	MM 30,0	MM 37,0
Crystal (001)		■	■	■
Crystal Effects				
Transparent Effects				
Crystal AB (001 AB)		■	■	■
Crystal Golden Shadow (001 GSHA)		■	■	■
Crystal Silver Shade (001 SSHA)		■	■	■

6022 XIRIUS Raindrop Pendant

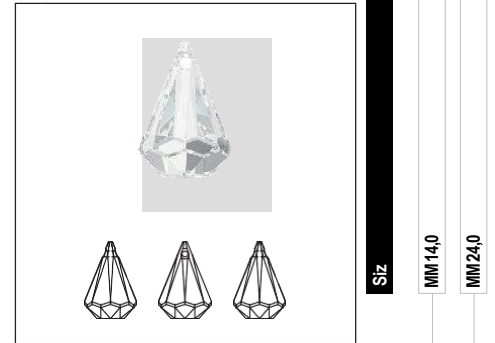

Crystal		MM 14,0	MM 24,0
Crystal (001)		■	■
Crystal Effects			
Transparent Effects			
Crystal AB (001 AB)		■	■
Crystal Blue Shade (001 BLSH)		■	■
Crystal Golden Shadow (001 GSHA)		■	■
Crystal Satin (001 SATIN)		■	■

6028 XILION Oval Pendant

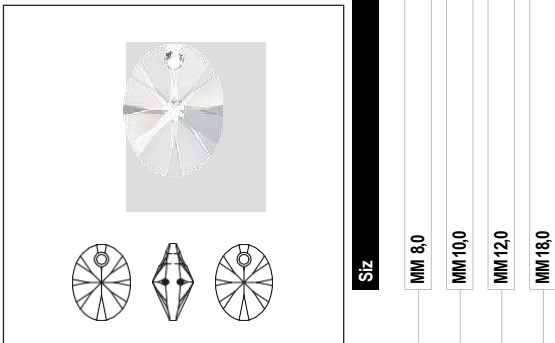

Crystal		MM 8,0	MM 10,0	MM 12,0	MM 18,0
Crystal (001)		■	■	■	■
Crystal Effects					
Transparent Effects					
Crystal AB (001 AB)		■	■	■	■
Crystal Golden Shadow (001 GSHA)		■	■	■	■
Crystal Silver Night (001 SINI)		■	■	■	■
Crystal Vitrail Light P (001 VL)		■	■	■	■

6039 Disk Pendant

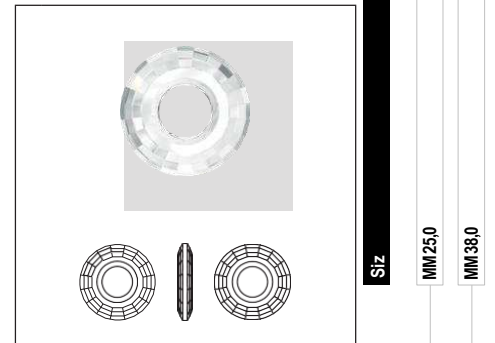

Crystal		MM 25,0	MM 38,0
Crystal (001)		■	■
Crystal Effects			
Transparent Effects			
Crystal Bermuda Blue P (001 BB)		■	■
Crystal Golden Shadow (001 GSHA)		■	■
Crystal Silver Night (001 SINI)		■	■
Metallic Effects			
Crystal Iridescent Green (001 IRIG)		■	■

¹ For details about the protective coating, please refer to the chapter 'Basic Information.'

6040 Helios Pendant

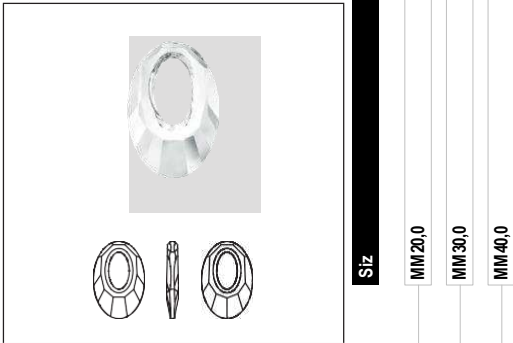

Siz

MM 20,0
MM 30,0
MM 40,0

Crystal

Crystal (001) [checkboxes]

Crystal Effects

Transparent Effects

Crystal AB (001 AB) [checkboxes]

Crystal Golden Shadow (001 GSHA) [checkboxes]

Crystal Paradise Shine (001 PARSH) [checkboxes]

Crystal Silver Night (001 SINI) [checkboxes]

Crystal Vitrail Medium P (001 VM) [checkboxes]

6041 Victory Pendant

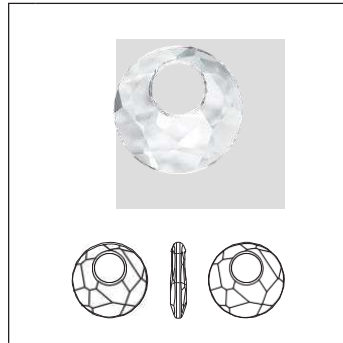

Siz

MM 18,0
MM 28,0
MM 38,0

Crystal

Crystal (001) [checkboxes]

Colors

Plain Colors

Aquamarine (202) [checkboxes]

Jet (280) [checkboxes]

Crystal Effects

Transparent Effects

Crystal AB (001 AB) [checkboxes]

Crystal Golden Shadow (001 GSHA) [checkboxes]

Crystal Paradise Shine (001 PARSH) [checkboxes]

Crystal Satin (001 SATIN) [checkboxes]

6049

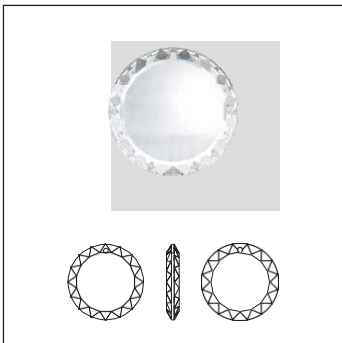

Siz

MM 20,0
MM 30,0

Crystal

Crystal (001) [checkboxes]

¹ For details about the protective coating, please refer to the chapter 'Basic Information.'

6090 Baroque Pendant

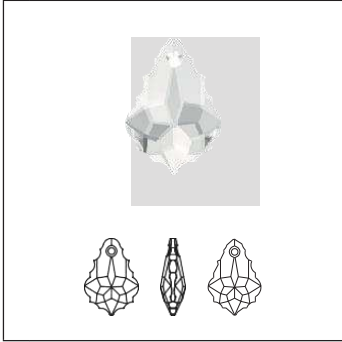

Siz
MM 16,0X 11,0
MM 22,0X 15,0

- Crystal**
- Crystal (001)
- Colors**
- Plain Colors
- Aquamarine (202)
- Jet (280)
- Ruby (501)
- Crystal Effects**
- Transparent Effects
- Crystal AB (001 AB)
- Crystal Golden Shadow (001 GSHA)
- Crystal Paradise Shine (001 PARSH)

6100

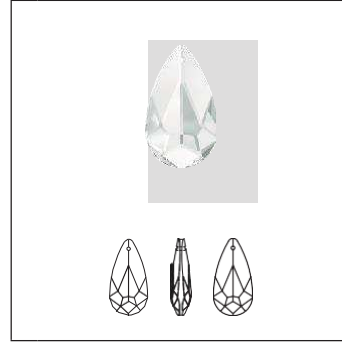

Siz
MM 24,0X 12,0

- Crystal**
- Crystal (001)
- Colors**
- Plain Colors
- Fireopal (237)
- Crystal Effects**
- Transparent Effects
- Crystal AB (001 AB)
- Crystal Bermuda Blue (001 BB)
- Crystal Vitrail Light (001 VL)
- Crystal Vitrail Medium (001 VM)

CORE ASSORTMENT

6106 Pear-shaped Pendant

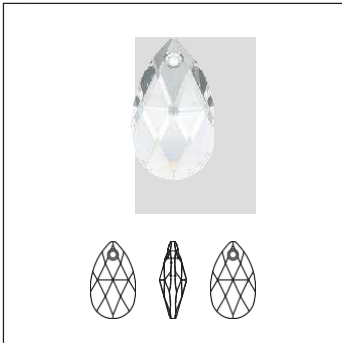

Siz	MM 16,0	MM 22,0	MM 28,0	MM 38,0
-----	---------	---------	---------	---------

	MM 16,0	MM 22,0	MM 28,0	MM 38,0
Crystal				
Crystal (001)	■	■	■	■
Colors				
Plain Colors				
Amethyst (204)	■	■	■	
Aquamarine (202)	■	■	■	
Black Diamond (215)	■	■	■	
Emerald (205)	■	■	■	
Erinite (360)	■	■	■	
Graphite (253)	■	■	■	
Iris (219)	■	■	■	
Jet (280)	■	■	■	
Light Amethyst (212)	■	■	■	
Light Colorado Topaz (246)	■	■	■	
Light Rose (223)	■	■	■	
Light Sapphire (211)	■	■	■	
Light Siam (227)	■	■	■	
Light Topaz (226)	■	■	■	
Majestic Blue (296)	■	■	■	
Peridot (214)	■	■	■	
Ruby (501)	■	■	■	
Scarlet (276)	■	■	■	
Tanzanite (539)	■	■	■	
Crystal Effects				
Transparent Effects				
Crystal Antique Pink (001 ANTP)	■	■	■	
Crystal Astral Pink (001 API)	■	■	■	
Crystal AB (001 AB)	■	■	■	
Crystal Blue Shade (001 BLSH)	■	■	■	
Crystal Golden Shadow (001 GSHA)	■	■	■	■
Crystal Luminous Green (001 LUMG)	■	■	■	
Crystal Paradise Shine (001 PARSH)	■	■	■	
Crystal Shimmer (001 SHIM)	■	■	■	
Crystal Silver Night (001 SINI)	■	■	■	
Crystal Silver Shade (001 SSHA)	■	■	■	■

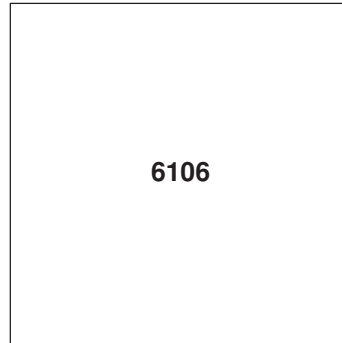

Siz	MM 16,0	MM 22,0	MM 28,0	MM 38,0
-----	---------	---------	---------	---------

	MM 16,0	MM 22,0	MM 28,0	MM 38,0
Metallic Effects				
Crystal Light Chrome (001 LTCH)	■	■	■	
Crystal Rainbow Dark (001 RABDK)	■	■	■	
Crystal Scarabaeus Green (001 SCGR)	■	■	■	
Color Effects				
Amethyst Shimmer (204 SHIM)	■	■	■	
Aquamarine Shimmer (202 SHIM)	■	■	■	
Black Diamond Shimmer (215 SHIM)	■	■	■	
Emerald Shimmer (205 SHIM)	■	■	■	
Erinite Shimmer (360 SHIM)	■	■	■	
Light Amethyst Shimmer (212 SHIM)	■	■	■	
Light Colorado Topaz Shimmer (246 SHIM)	■	■	■	
Light Rose Shimmer (223 SHIM)	■	■	■	
Light Sapphire Shimmer (211 SHIM)	■	■	■	
Light Siam Shimmer (227 SHIM)	■	■	■	
Light Topaz Shimmer (226 SHIM)	■	■	■	

6128 XILION Mini Pear Pendant

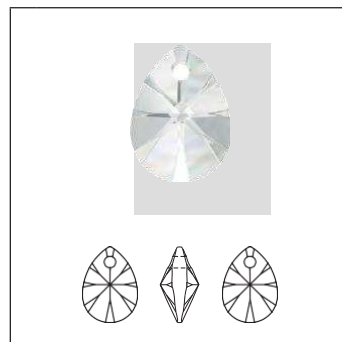

Siz	MM 8,0	MM 10,0	MM 12,0
-----	--------	---------	---------

	MM 8,0	MM 10,0	MM 12,0
Crystal			
Crystal (001)	■	■	■
Colors			
Plain Colors			
Denim Blue (266)	■	■	■
Jet (280)	■	■	■
Crystal Effects			
Transparent Effects			
Crystal AB (001 AB)	■	■	■
Crystal Golden Shadow (001 GSHA)	■	■	■
Crystal Paradise Shine (001 PARSH)	■	■	■

*** designed by Jean Paul Gaultier

◆ Core Assortment

6150 PegasusPendant

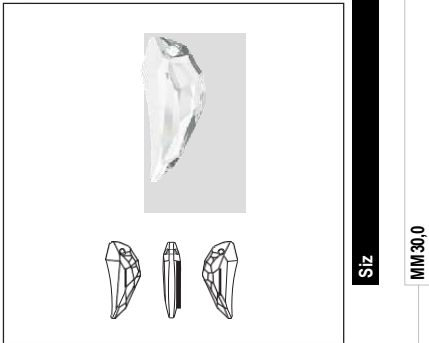

Siz

MM 30,0

Crystal

Crystal (001)

Colors

Plain Colors

Jet (280)

Crystal Effects

Transparent Effects

Crystal Golden Shadow (001 GSHA)

Crystal Satin (001 SATIN)

6210

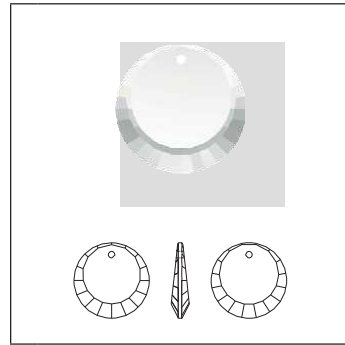

Siz

MM 12,0

MM 17,0

Crystal

Crystal (001)

Crystal Effects

Transparent Effects

Crystal AB (001 AB)

6215

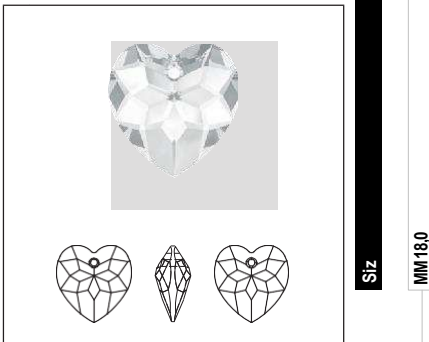

Siz

MM 18,0

Crystal

Crystal (001)

Crystal Effects

Transparent Effects

Crystal AB (001 AB)

Crystal Bermuda Blue P (001 BB)

Crystal Red Magma (001 REDM)

6225

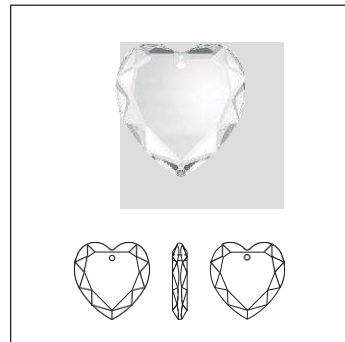

Siz

MM 10,0

MM 18,0

MM 28,0

Crystal

Crystal (001)

¹ For details about the protective coating, please refer to the chapter 'Basic Information.'

CORE ASSORTMENT

6228 XILION Heart Pendant

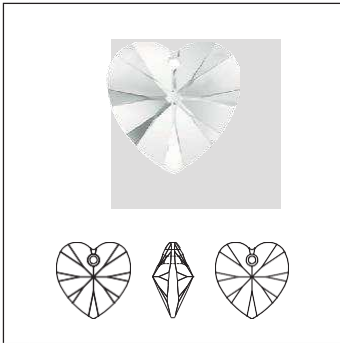

Siz	MM 10,3X 10,0	MM 14,4X 14,0	MM 18,0X 17,5	MM 28,0	MM 40,0
-----	---------------	---------------	---------------	---------	---------

Crystal

Crystal (001)	■	■	■	■	■
---------------	---	---	---	---	---

Colors

Plain Colors

Amethyst (204)	■	■	■		
Aquamarine (202)	■	■	■		
Black Diamond (215)	■	■	■		
Blue Zircon (229)	■	■	■		
Emerald (205)	■	■	■		
Erinite (360)	■	■	■		
Fuchsia (502)	■	■			
Iris (219)	■	■	■		
Jet (280)	■	■	■		
Light Amethyst (212)	■	■	■		
Light Colorado Topaz (246)	■	■	■		
Light Rose (223)	■	■	■		
Light Sapphire (211)	■	■	■		
Light Siam (227)	■	■	■		
Light Topaz (226)	■	■	■		
Light Turquoise (263)	■	■	■		
Majestic Blue (296)	■	■	■		
Peridot (214)	■	■	■		
Rose (209)	■	■	■		
Rose Peach (262)	■	■	■		
Sapphire (206)	■	■	■		
Scarlet (276)	■	■	■		
Siam (208)	■	■	■		
Tanzanite (539)	■	■			
Violet (371)	■	■			

Crystal Effects

Transparent Effects

Crystal AB (001 AB)	■	■	■	■	■
Crystal Bermuda Blue (001 BB)	■	■	■		
Crystal Bermuda Blue P (001 BB)				■	
Crystal Golden Shadow (001 GSHA)	■	■	■		

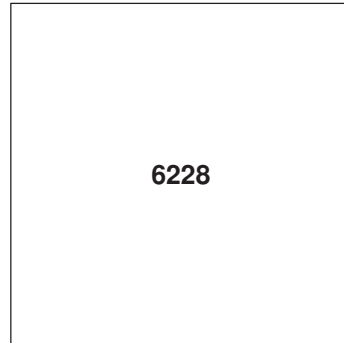

Siz	MM 10,3X 10,0	MM 14,4X 14,0	MM 18,0X 17,5	MM 28,0	MM 40,0
-----	---------------	---------------	---------------	---------	---------

Crystal Heliotrope (001 HEL)	■	■	■		
Crystal Moonlight (001 MOL)	■	■	■		
Crystal Paradise Shine (001 PARSH)	■	■	■		
Crystal Shimmer (001 SHIM)	■	■	■		
Crystal Silver Night (001 SINI)	■	■	■	■	
Crystal Vitrail Light (001 VL)	■	■	■		
Crystal Vitrail Medium (001 VM)	■	■	■		

Metallic Effects

Crystal Light Chrome (001 LTCH)	■	■			
Crystal Metallic Sunshine (001 METSH)	■	■			
Crystal Rainbow Dark (001 RABDK)	■	■	■		
Crystal Scarabaeus Green (001 SCGR)	■	■			

Color Effects

Amethyst Shimmer (204 SHIM)	■	■	■		
Aquamarine AB (202 AB)	■	■	■		
Aquamarine Shimmer (202 SHIM)	■	■	■		
Black Diamond Shimmer (215 SHIM)	■	■	■		
Blue Zircon AB (229 AB)	■				
Emerald Shimmer (205 SHIM)	■	■	■		
Erinite Shimmer (360 SHIM)	■	■	■		
Fuchsia AB (502 AB)	■				
Light Amethyst Shimmer (212 SHIM)	■	■	■		
Light Colorado Topaz Shimmer (246 SHIM)	■	■	■		
Light Rose AB (223 AB)	■	■			
Light Rose Shimmer (223 SHIM)	■	■	■		
Light Sapphire Shimmer (211 SHIM)	■	■	■		
Light Siam AB (227 AB)	■				
Light Siam Shimmer (227 SHIM)	■	■	■		
Light Topaz AB (226 AB)	■	■	■		
Light Topaz Shimmer (226 SHIM)	■	■	■		
Peridot AB (214 AB)	■	■	■		
Rose AB (209 AB)	■	■			
Rose Peach Shimmer (262 SHIM)	■	■	■		
Sapphire AB (206 AB)	■				
Siam AB (208 AB)	■	■	■		
Violet AB (371 AB)	■	■			

*** designed by Jean Paul Gaultier

¹ For details about the protective coating, please refer to the chapter 'Basic Information.'

◆ Core Assortment

6240 Wild Heart Pendant

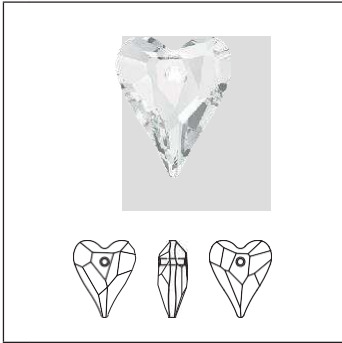

Siz	MM 12,0	MM 17,0	MM 27,0
	Crystal	■	■
Crystal (001)	■	■	■
Colors			
Plain Colors			
Aquamarine (202)	■	■	■
Rosaline (508)	■	■	■
Tanzanite (539)	■	■	■
Crystal Effects			
Transparent Effects			
Crystal AB (001 AB)	■	■	■
Crystal Golden Shadow (001 GSHA)	■	■	■
Crystal Red Magma (001 REDM)	■	■	■
Crystal Vitrail Medium P (001 VM)		■	■

Crystal

Crystal (001)

Colors

Plain Colors

Aquamarine (202)

Rosaline (508)

Tanzanite (539)

Crystal Effects

Transparent Effects

Crystal AB (001 AB)

Crystal Golden Shadow (001 GSHA)

Crystal Red Magma (001 REDM)

Crystal Vitrail Medium P (001 VM)

¹ For details about the protective coating, please refer to the chapter 'Basic Information.'

"LOVE STORY OF THE HEART" BY MANISH ARORA

DESIGNER EDITION

Since the beginning of his international career, the award-winning, Delhi-based designer Manish Arora has worked creatively with Swarovski. In 2009, he created a memorable collection of crystalline Transfers. One year later, India's best-loved and most prolific design talent renewed his partnership with Swarovski and created a special collection of heart-shaped crystal pendants, which were launched in February 2011. Each individual piece is an expression of love's different emotional states and is named accordingly.

The partnership with Manish Arora is symbolic of how Swarovski engages in mutually rewarding creative partnerships with the world's best and brightest design spirits.

"The heart shape is very close to me because it is the universal symbol of love. I wanted to bring this symbol to life by creating a collection of crystal pendants and I hope people will wear them as a personal expression of the beauty and purity of this emotion." Manish Arora

DESIGNER EDITION

6261 Devoted2 U Heart

	MM 17.0	MM 27.0	MM 36.0
Crystal			
Crystal (001)	■	■	■
Colors			
Plain Colors			
Amethyst (204)	■		
Aquamarine (202)	■		
Rosaline (508)	■		
Crystal Effects			
Transparent Effects			
Crystal Antique Pink (001 ANTP)	■		
Crystal AB (001 AB)	■	■	■
Crystal Golden Shadow (001 GSHA)	■	■	
Crystal Red Magma (001 REDM)	■	■	
Crystal Vitrail Medium P (001 VM)	■	■	
Metallic Effects			
Crystal Comet Argent Light V P (001 CAV)	■	■	

6262 Miss U Heart

	MM 17.0	MM 26.0	MM 34.0
Crystal			
Crystal (001)	■	■	■
Crystal Effects			
Transparent Effects			
Crystal AB (001 AB)	■	■	■

¹ For details about the protective coating, please refer to the chapter 'Basic Information.'

6264 Truly in LoveHeart

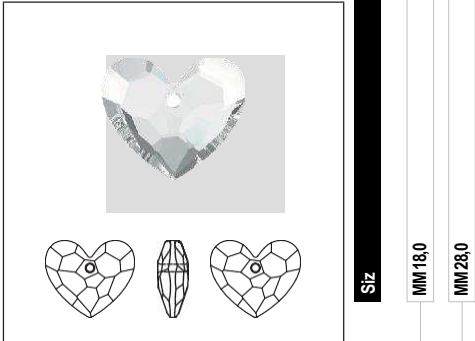

Crystal	
Crystal (001)	■ ■
Crystal Effects	
Transparent Effects	
Crystal AB (001 AB)	■ ■
Crystal Bermuda Blue P (001 BB)	■ ■
Crystal Golden Shadow (001 GSHA)	■ ■
Crystal Red Magma (001 REDM)	■ ■

DESIGNER EDITIONS – DISTINCT PACKAGING

This Designer Edition will be labeled with the "Designer Edition" imprint directly on the packaging.

¹ For details about the protective coating, please refer to the chapter 'Basic Information.'

6320 RhombusPendant

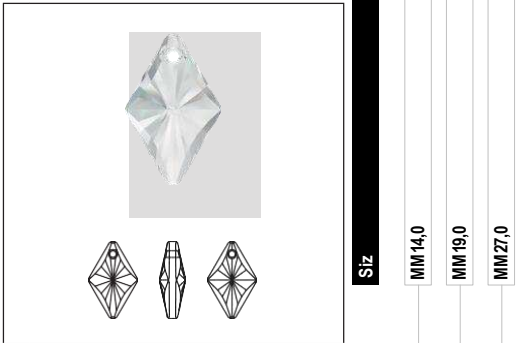

Siz

MM 14,0
MM 19,0
MM 27,0

Crystal

Crystal (001)

Crystal Effects

Transparent Effects

Crystal AB (001 AB)

Crystal Golden Shadow (001 GSHA)

6328 XILION Bi-ConePendant

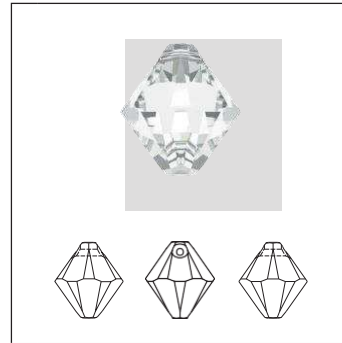

Siz

MM 6,0
MM 8,0

Crystal

Crystal (001)

Colors

Plain Colors

Aquamarine (202)

Light Rose (223)

Violet (371)

Crystal Effects

Transparent Effects

Crystal AB (001 AB)

Crystal Golden Shadow (001 GSHA)

Metallic Effects

Crystal Rose Gold 2x (001 ROGL2)

6401 OctagonPendant

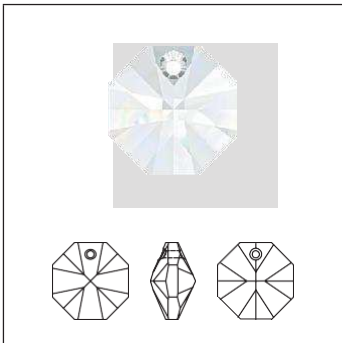

Siz

MM 8,0
MM 12,0

Crystal

Crystal (001)

Colors

Plain Colors

Aquamarine (202)

Crystal Effects

Transparent Effects

Crystal AB (001 AB)

Crystal Golden Shadow (001 GSHA)

Crystal Silver Shade (001 SSHA)

CORE ASSORTMENT

6428 XILION Pendant

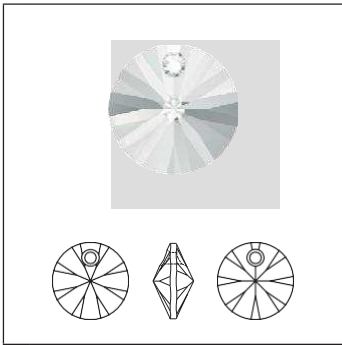

Siz	MM 6,0	MM 8,0	MM 12,0
-----	--------	--------	---------

Crystal

Crystal (001)	■	■	■
---------------	---	---	---

Colors

Plain Colors

Amethyst (204)	■	■	■
Aquamarine (202)	■	■	■
Denim Blue (266)	■	■	
Emerald (205)	■	■	■
Iris (219)	■	■	■
Jet (280)	■	■	■
Light Colorado Topaz (246)	■	■	■
Light Rose (223)	■	■	■
Light Siam (227)	■	■	
Light Turquoise (263)	■	■	
Majestic Blue (296)		■	■
Rose (209)	■	■	
Rose Peach (262)	■	■	
Scarlet (276)	■	■	■
Siam (208)	■	■	
Violet (371)	■	■	

Opal Colors

Yellow Opal (231)	■	■	
-------------------	---	---	--

Crystal Effects

Transparent Effects

Crystal Antique Pink (001 ANTP)	■	■	■
Crystal AB (001 AB)	■	■	■
Crystal Blue Shade (001 BLSH)	■	■	
Crystal Bronze Shade (001 BRSH)	■	■	■
Crystal Golden Shadow (001 GSHA)	■	■	
Crystal Paradise Shine (001 PARSH)	■	■	
Crystal Shimmer (001 SHIM)	■	■	
Crystal Silver Night (001 SINI)	■	■	
Crystal Silver Shade (001 SSHA)	■	■	

Color Effects

Amethyst Shimmer (204 SHIM)	■	■	
-----------------------------	---	---	--

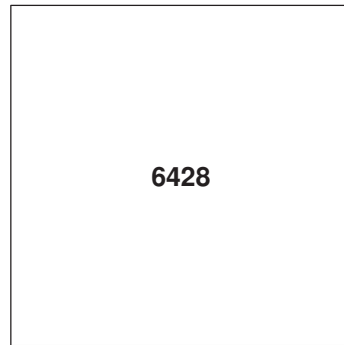

Siz	MM 6,0	MM 8,0	MM 12,0
-----	--------	--------	---------

Aquamarine Shimmer (202 SHIM)	■	■	
Emerald Shimmer (205 SHIM)	■	■	
Light Colorado Topaz Shimmer (246 SHIM)	■	■	
Light Rose Shimmer (223 SHIM)	■	■	
Light Siam Shimmer (227 SHIM)	■	■	
Rose Peach Shimmer (262 SHIM)	■	■	

¹ For details about the protective coating, please refer to the chapter 'Basic Information.'

6430 Classic Cut Pendant

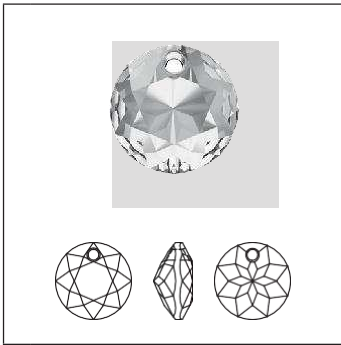

Siz	MM 8,0	MM 10,0	MM 14,0
-----	--------	---------	---------

Crystal

Crystal (001)	■	■	■
---------------	---	---	---

Colors

Plain Colors

Amethyst (204)	■	■	■
Aquamarine (202)	■	■	■
Emerald (205)	■	■	■
Jet (280)	■	■	■
Light Amethyst (212)	■	■	■
Light Colorado Topaz (246)	■	■	■
Light Rose (223)	■	■	■
Light Siam (227)	■	■	■
Majestic Blue (296)	■	■	■
Montana (207)	■	■	■
Peridot (214)	■	■	■
Rose (209)	■	■	■
Sapphire (206)	■	■	■
Scarlet (276)	■	■	■
Siam (208)	■	■	■
Topaz (203)	■	■	■

Crystal Effects

Transparent Effects

Crystal AB (001 AB)	■	■	■
Crystal Bermuda Blue P (001 BB)	■	■	■
Crystal Golden Shadow (001 GSHA)	■	■	■
Crystal Shimmer (001 SHIM)	■	■	■
Crystal Silver Night (001 SINI)	■	■	■
Crystal Vitrail Light P (001 VL)	■	■	■
Crystal Vitrail Medium P (001 VM)	■	■	■

Color Effects

Amethyst Shimmer (204 SHIM)	■	■	■
Aquamarine Shimmer (202 SHIM)	■	■	■
Emerald Shimmer (205 SHIM)	■	■	■
Light Colorado Topaz Shimmer (246 SHIM)	■	■	■
Light Rose Shimmer (223 SHIM)	■	■	■

6431 PRINCESS CUT PENDANT



Siz	MM 9,0	MM 11,5	MM 16,0
-----	--------	---------	---------

Crystal

Crystal (001)	<input checked="" type="checkbox"/>	<input checked="" type="checkbox"/>	<input checked="" type="checkbox"/>
---------------	-------------------------------------	-------------------------------------	-------------------------------------

Colors

Plain Colors

Amethyst (204)	<input checked="" type="checkbox"/>	<input checked="" type="checkbox"/>	<input checked="" type="checkbox"/>
Aquamarine (202)	<input checked="" type="checkbox"/>	<input checked="" type="checkbox"/>	<input checked="" type="checkbox"/>
Emerald (205)	<input checked="" type="checkbox"/>	<input checked="" type="checkbox"/>	<input checked="" type="checkbox"/>
Jet (280)	<input checked="" type="checkbox"/>	<input checked="" type="checkbox"/>	<input checked="" type="checkbox"/>
Light Amethyst (212)	<input checked="" type="checkbox"/>	<input checked="" type="checkbox"/>	<input checked="" type="checkbox"/>
Light Colorado Topaz (246)	<input checked="" type="checkbox"/>	<input checked="" type="checkbox"/>	<input checked="" type="checkbox"/>
Light Rose (223)	<input checked="" type="checkbox"/>	<input checked="" type="checkbox"/>	<input checked="" type="checkbox"/>
Light Siam (227)	<input checked="" type="checkbox"/>	<input checked="" type="checkbox"/>	<input checked="" type="checkbox"/>
Majestic Blue (296)	<input checked="" type="checkbox"/>	<input checked="" type="checkbox"/>	<input checked="" type="checkbox"/>
Montana (207)	<input checked="" type="checkbox"/>	<input checked="" type="checkbox"/>	<input checked="" type="checkbox"/>
Peridot (214)	<input checked="" type="checkbox"/>	<input checked="" type="checkbox"/>	<input checked="" type="checkbox"/>
Rose (209)	<input checked="" type="checkbox"/>	<input checked="" type="checkbox"/>	<input checked="" type="checkbox"/>
Sapphire (206)	<input checked="" type="checkbox"/>	<input checked="" type="checkbox"/>	<input checked="" type="checkbox"/>
Scarlet (276)	<input checked="" type="checkbox"/>	<input checked="" type="checkbox"/>	<input checked="" type="checkbox"/>
Siam (208)	<input checked="" type="checkbox"/>	<input checked="" type="checkbox"/>	<input checked="" type="checkbox"/>
Topaz (203)	<input checked="" type="checkbox"/>	<input checked="" type="checkbox"/>	<input checked="" type="checkbox"/>

Crystal Effects

Transparent Effects

Crystal AB (001 AB)	<input checked="" type="checkbox"/>	<input checked="" type="checkbox"/>	<input checked="" type="checkbox"/>
Crystal Bermuda Blue P (001 BB)	<input checked="" type="checkbox"/>	<input checked="" type="checkbox"/>	<input checked="" type="checkbox"/>
Crystal Golden Shadow (001 GSHA)	<input checked="" type="checkbox"/>	<input checked="" type="checkbox"/>	<input checked="" type="checkbox"/>
Crystal Shimmer (001 SHIM)	<input checked="" type="checkbox"/>	<input checked="" type="checkbox"/>	<input checked="" type="checkbox"/>
Crystal Silver Night (001 SINI)	<input checked="" type="checkbox"/>	<input checked="" type="checkbox"/>	<input checked="" type="checkbox"/>
Crystal Vitrail Light P (001 VL)	<input checked="" type="checkbox"/>	<input checked="" type="checkbox"/>	<input checked="" type="checkbox"/>
Crystal Vitrail Medium P (001 VM)	<input checked="" type="checkbox"/>	<input checked="" type="checkbox"/>	<input checked="" type="checkbox"/>

Color Effects

Amethyst Shimmer (204 SHIM)	<input checked="" type="checkbox"/>	<input checked="" type="checkbox"/>	<input checked="" type="checkbox"/>
Aquamarine Shimmer (202 SHIM)	<input checked="" type="checkbox"/>	<input checked="" type="checkbox"/>	<input checked="" type="checkbox"/>
Emerald Shimmer (205 SHIM)	<input checked="" type="checkbox"/>	<input checked="" type="checkbox"/>	<input checked="" type="checkbox"/>
Light Colorado Topaz Shimmer (246 SHIM)	<input checked="" type="checkbox"/>	<input checked="" type="checkbox"/>	<input checked="" type="checkbox"/>
Light Rose Shimmer (223 SHIM)	<input checked="" type="checkbox"/>	<input checked="" type="checkbox"/>	<input checked="" type="checkbox"/>

6432 HEART CUT PENDANT



Siz	MM 8,0	MM 10,5	MM 14,5
-----	--------	---------	---------

Crystal

Crystal (001)	<input checked="" type="checkbox"/>	<input checked="" type="checkbox"/>	<input checked="" type="checkbox"/>
---------------	-------------------------------------	-------------------------------------	-------------------------------------

Colors

Plain Colors

Amethyst (204)	<input checked="" type="checkbox"/>	<input checked="" type="checkbox"/>	<input checked="" type="checkbox"/>
Aquamarine (202)	<input checked="" type="checkbox"/>	<input checked="" type="checkbox"/>	<input checked="" type="checkbox"/>
Emerald (205)	<input checked="" type="checkbox"/>	<input checked="" type="checkbox"/>	<input checked="" type="checkbox"/>
Jet (280)	<input checked="" type="checkbox"/>	<input checked="" type="checkbox"/>	<input checked="" type="checkbox"/>
Light Amethyst (212)	<input checked="" type="checkbox"/>	<input checked="" type="checkbox"/>	<input checked="" type="checkbox"/>
Light Colorado Topaz (246)	<input checked="" type="checkbox"/>	<input checked="" type="checkbox"/>	<input checked="" type="checkbox"/>
Light Rose (223)	<input checked="" type="checkbox"/>	<input checked="" type="checkbox"/>	<input checked="" type="checkbox"/>
Light Siam (227)	<input checked="" type="checkbox"/>	<input checked="" type="checkbox"/>	<input checked="" type="checkbox"/>
Majestic Blue (296)	<input checked="" type="checkbox"/>	<input checked="" type="checkbox"/>	<input checked="" type="checkbox"/>
Montana (207)	<input checked="" type="checkbox"/>	<input checked="" type="checkbox"/>	<input checked="" type="checkbox"/>
Peridot (214)	<input checked="" type="checkbox"/>	<input checked="" type="checkbox"/>	<input checked="" type="checkbox"/>
Rose (209)	<input checked="" type="checkbox"/>	<input checked="" type="checkbox"/>	<input checked="" type="checkbox"/>
Sapphire (206)	<input checked="" type="checkbox"/>	<input checked="" type="checkbox"/>	<input checked="" type="checkbox"/>
Scarlet (276)	<input checked="" type="checkbox"/>	<input checked="" type="checkbox"/>	<input checked="" type="checkbox"/>
Siam (208)	<input checked="" type="checkbox"/>	<input checked="" type="checkbox"/>	<input checked="" type="checkbox"/>
Topaz (203)	<input checked="" type="checkbox"/>	<input checked="" type="checkbox"/>	<input checked="" type="checkbox"/>

Crystal Effects

Transparent Effects

Crystal AB (001 AB)	<input checked="" type="checkbox"/>	<input checked="" type="checkbox"/>	<input checked="" type="checkbox"/>
Crystal Bermuda Blue P (001 BB)	<input checked="" type="checkbox"/>	<input checked="" type="checkbox"/>	<input checked="" type="checkbox"/>
Crystal Golden Shadow (001 GSHA)	<input checked="" type="checkbox"/>	<input checked="" type="checkbox"/>	<input checked="" type="checkbox"/>
Crystal Shimmer (001 SHIM)	<input checked="" type="checkbox"/>	<input checked="" type="checkbox"/>	<input checked="" type="checkbox"/>
Crystal Silver Night (001 SINI)	<input checked="" type="checkbox"/>	<input checked="" type="checkbox"/>	<input checked="" type="checkbox"/>
Crystal Vitrail Light P (001 VL)	<input checked="" type="checkbox"/>	<input checked="" type="checkbox"/>	<input checked="" type="checkbox"/>
Crystal Vitrail Medium P (001 VM)	<input checked="" type="checkbox"/>	<input checked="" type="checkbox"/>	<input checked="" type="checkbox"/>

Color Effects

Amethyst Shimmer (204 SHIM)	<input checked="" type="checkbox"/>	<input checked="" type="checkbox"/>	<input checked="" type="checkbox"/>
Aquamarine Shimmer (202 SHIM)	<input checked="" type="checkbox"/>	<input checked="" type="checkbox"/>	<input checked="" type="checkbox"/>
Emerald Shimmer (205 SHIM)	<input checked="" type="checkbox"/>	<input checked="" type="checkbox"/>	<input checked="" type="checkbox"/>
Light Colorado Topaz Shimmer (246 SHIM)	<input checked="" type="checkbox"/>	<input checked="" type="checkbox"/>	<input checked="" type="checkbox"/>
Light Rose Shimmer (223 SHIM)	<input checked="" type="checkbox"/>	<input checked="" type="checkbox"/>	<input checked="" type="checkbox"/>

6433 PEAR CUT PENDANT



Siz	MM 9,0	MM 11,5	MM 16,0
-----	--------	---------	---------

Crystal

Crystal (001)	■	■	■
---------------	---	---	---

Colors

Plain Colors

Amethyst (204)	■	■	■
Aquamarine (202)	■	■	■
Emerald (205)	■	■	■
Jet (280)	■	■	■
Light Amethyst (212)	■	■	■
Light Colorado Topaz (246)	■	■	■
Light Rose (223)	■	■	■
Light Siam (227)	■	■	■
Majestic Blue (296)	■	■	■
Montana (207)	■	■	■
Peridot (214)	■	■	■
Rose (209)	■	■	■
Sapphire (206)	■	■	■
Scarlet (276)	■	■	■
Siam (208)	■	■	■
Topaz (203)	■	■	■

Crystal Effects

Transparent Effects

Crystal AB (001 AB)	■	■	■
Crystal Bermuda Blue P (001 BB)	■	■	■
Crystal Golden Shadow (001 GSHA)	■	■	■
Crystal Shimmer (001 SHIM)	■	■	■
Crystal Silver Night (001 SINI)	■	■	■
Crystal Vitrail Light P (001 VL)	■	■	■
Crystal Vitrail Medium P (001 VM)	■	■	■

Color Effects

Amethyst Shimmer (204 SHIM)	■	■	■
Aquamarine Shimmer (202 SHIM)	■	■	■
Emerald Shimmer (205 SHIM)	■	■	■
Light Colorado Topaz Shimmer (246 SHIM)	■	■	■
Light Rose Shimmer (223 SHIM)	■	■	■

6435 EMERALD CUT PENDANT



Siz	MM 9,0	MM 11,5	MM 16,0
-----	--------	---------	---------

Crystal

Crystal (001)	■	■	■
---------------	---	---	---

Colors

Plain Colors

Amethyst (204)	■	■	■
Aquamarine (202)	■	■	■
Emerald (205)	■	■	■
Jet (280)	■	■	■
Light Amethyst (212)	■	■	■
Light Colorado Topaz (246)	■	■	■
Light Rose (223)	■	■	■
Light Siam (227)	■	■	■
Majestic Blue (296)	■	■	■
Montana (207)	■	■	■
Peridot (214)	■	■	■
Rose (209)	■	■	■
Sapphire (206)	■	■	■
Scarlet (276)	■	■	■
Siam (208)	■	■	■
Topaz (203)	■	■	■

Crystal Effects

Transparent Effects

Crystal AB (001 AB)	■	■	■
Crystal Bermuda Blue P (001 BB)	■	■	■
Crystal Golden Shadow (001 GSHA)	■	■	■
Crystal Shimmer (001 SHIM)	■	■	■
Crystal Silver Night (001 SINI)	■	■	■
Crystal Vitrail Light P (001 VL)	■	■	■
Crystal Vitrail Medium P (001 VM)	■	■	■

Color Effects

Amethyst Shimmer (204 SHIM)	■	■	■
Aquamarine Shimmer (202 SHIM)	■	■	■
Emerald Shimmer (205 SHIM)	■	■	■
Light Colorado Topaz Shimmer (246 SHIM)	■	■	■
Light Rose Shimmer (223 SHIM)	■	■	■

1 For details about the protective coating, please refer to the chapter 'Basic Information.'

6460 Column Pendant

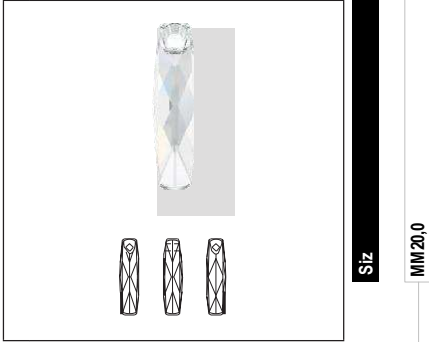

Siz

MM 20,0

Crystal

Crystal (001)

Crystal Effects

Transparent Effects

Crystal AB (001 AB)

Crystal Golden Shadow (001 GSHA)

Crystal Silver Shade (001 SSHA)

6465 Queen Baguette Pendant

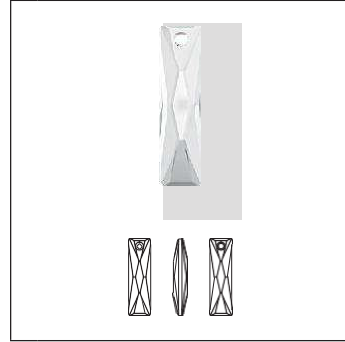

Siz

MM 13,5X 6,0

MM 25,0X 7,0

MM 38,0X 10,0

Crystal

Crystal (001)

Colors

Plain Colors

Aquamarine (202)

Jet (280)

Montana (207)

Crystal Effects

Transparent Effects

Crystal AB (001 AB)

Crystal Bermuda Blue P (001 BB)

Crystal Golden Shadow (001 GSHA)

Crystal Silver Night (001 SIN)

Crystal Vitrail Light P (001 VL)

Crystal Volcano P (001 VOL)

Metallic Effects

Crystal CAL V SI P (001 CAVSI)

¹ For details about the protective coating, please refer to the chapter 'Basic Information.'

6480 Spike Pendant

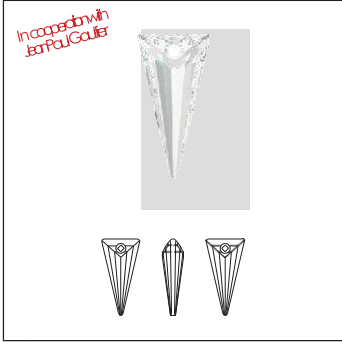

Siz	MM 18,0	MM 28,0	MM 39,0
-----	---------	---------	---------

Crystal	MM 18,0	MM 28,0	MM 39,0
Crystal (001)	■	■	■
Colors			
Plain Colors			
Jet (280)	■	■	■
Crystal Effects			
Transparent Effects			
Crystal Antique Pink (001 ANTP)	■	■	
Crystal AB (001 AB)	■	■	■
Crystal Bermuda Blue P (001 BB)	■	■	■
Crystal Blue Shade (001 BLSH)	■	■	
Crystal Golden Shadow (001 GSHA)	■	■	■
Crystal Silver Night (001 SINI)	■	■	■
Crystal Vitrail Medium P (001 VM)	■	■	■
Metallic Effects			
Crystal Rainbow Dark (001 RABDK)	■	■	
Crystal Patina			
Crystal Rose Patina (001 ROSPA)	■	■	■
Crystal Silver Patina (001 SILPA)	■	■	■
Crystal White Patina (001 WHIPA)	■	■	■

HALF HOLE PENDANTS

6530 Pure Drop Pendant (half hole)

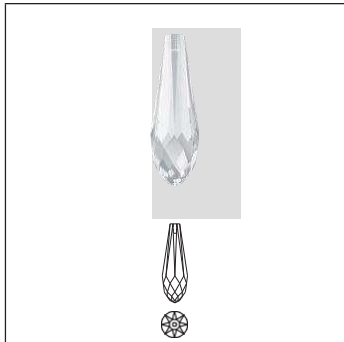

Siz	MM12,0	MM20,0	MM30,0
-----	--------	--------	--------

Crystal			
Crystal (001)	■	■	■
Colors			
Plain Colors			
Amethyst (204)	■	■	■
Aquamarine (202)	■	■	■
Emerald (205)	■	■	■
Jet (280)	■	■	■
Crystal Effects			
Transparent Effects			
Crystal AB (001 AB)	■	■	■
Crystal Golden Shadow (001 GSHA)	■	■	■

6532¹ Pure Drop Pendant (half hole) with trumpet cap



Siz	MM21,0	MM31,5	MM44,0
-----	--------	--------	--------

Crystal			
Crystal RHOD (001)	■	■	■
Crystal GOLD (001)	■	■	■
Colors			
Plain Colors			
Amethyst GOLD (204)	■	■	■
Amethyst RHOD (204)	■	■	■
Aquamarine GOLD (202)	■	■	■
Aquamarine RHOD (202)	■	■	■
Blush Rose GOLD (257)	■	■	■
Blush Rose RHOD (257)	■	■	■
Emerald GOLD (205)	■	■	■
Emerald RHOD (205)	■	■	■
Jet GOLD (280)	■	■	■
Jet RHOD (280)	■	■	■
Ruby RHOD (501)	■	■	■
Ruby GOLD (501)	■	■	■
Siam RHOD (208)	■		
Siam GOLD (208)	■		
Smoky Quartz RHOD (225)	■	■	■
Smoky Quartz GOLD (225)	■	■	■
Crystal Effects			
Transparent Effects			
Crystal AB RHOD (001 AB)	■	■	■
Crystal AB GOLD (001 AB)	■	■	■
Crystal Golden Shadow GOLD (001 GSHA)	■	■	■
Crystal Golden Shadow RHOD (001 GSHA)	■	■	■
Crystal Silver Shade RHOD (001 SSHA)	■	■	■
Crystal Silver Shade GOLD (001 SSHA)	■	■	■

¹ Please note that delivery for these items can take up to three weeks

² fits 6530 12 mm

³ fits 6530 20 mm

⁴ fits 6530 30 mm

HALF HOLE PENDANTS

65M001 Trumpet Cap

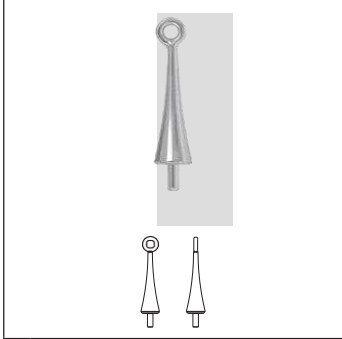

Siz	MM 9,0	MM 11,5	MM 14,0
-----	--------	---------	---------

BRASS	■	■	■
GOLD	■	■	■
GMET	■	■	■
RHOD	■	■	■
ROGL	■	■	■

65M002 Classic Cap

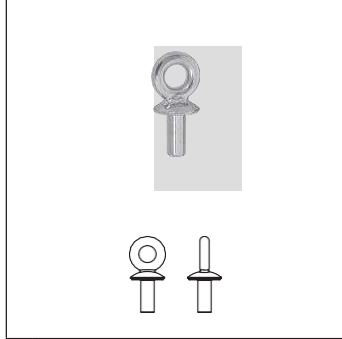

Siz	MM 3,5	MM 4,0
-----	--------	--------

RHOD	■	■
GOLD	■	■
BRASS	■	■
GMET	■	■
ROGL	■	■

¹ Please note that delivery for these items can take up to three weeks

² fits 6530 12 mm

³ fits 6530 20 mm

⁴ fits 6530 30 mm

6533 Raindrop Pendant

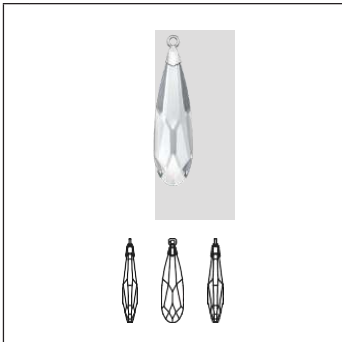

Siz	MM 17,5	MM 23,0	MM 33,0
-----	---------	---------	---------

Crystal

Crystal RHOD (001)	■	■	■
Crystal GOLD (001)	■	■	■

Colors

Plain Colors

Blush Rose RHOD (257)	■	■	■
Blush Rose GOLD (257)	■	■	■
Jet GOLD (280)	■	■	■
Jet RHOD (280)	■	■	■
Tanzanite GOLD (539)	■	■	■
Tanzanite RHOD (539)	■	■	■

Crystal Effects

Transparent Effects

Crystal AB RHOD (001 AB)	■	■	■
Crystal AB GOLD (001 AB)	■	■	■
Crystal Golden Shadow RHOD (001 GSHA)	■	■	■
Crystal Golden Shadow GOLD (001 GSHA)	■	■	■
Crystal Silver Night GOLD (001 SINI)	■	■	■
Crystal Silver Night RHOD (001 SINI)	■	■	■

METALLIC CAP PENDANTS

6565 Metallic Cap Pearshaped Pendant



Siz

MM 18,0

MM 22,0

Crystal Effects

Metallic Effects

Crystal Light Chrome Z MCI (001 LTCHZ)

Color Effects

Amethyst Light Chrome Z MCI (204 LTCHZ)

Aquamarine Light Chrome Z MCI (202 LTCHZ)

Black Diamond Light Chrome Z MCI (215 LT)

Emerald Light Chrome Z MCI (205 LTCHZ)

Jet Light Chrome Z MCI (280 LTCHZ)

Light Colorado Topaz Light Chrome Z MCI (2

Tanzanite Light Chrome Z MCI (539 LTCHZ)

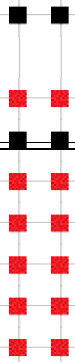

6621 Twist Pendant

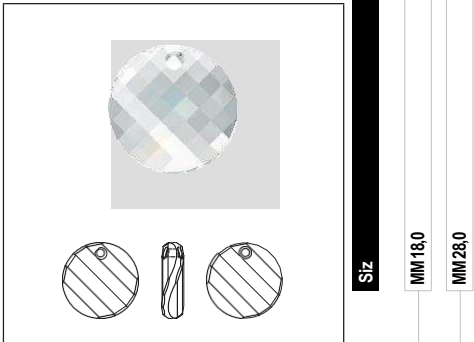

Siz
MM 18,0
MM 28,0

- Crystal**
- Crystal (001)
- Crystal Effects**
- Transparent Effects**
- Crystal Bermuda Blue P (001 BB)
- Crystal Golden Shadow (001 GSHA)
- Crystal Moonlight (001 MOL)
- Crystal Silver Night (001 SINI)
- Crystal Vitrail Medium P (001 VM)
- Metallic Effects**
- Crystal Comet Argent Light V P (001 CAV)

6628 XILION Triangle Pendant

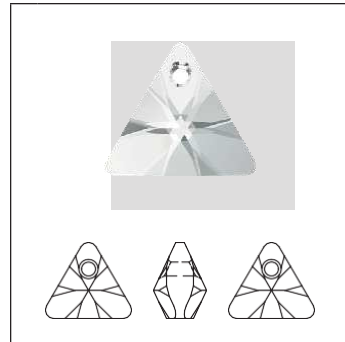

Siz
MM 8,0
MM 12,0
MM 16,0

- Crystal**
- Crystal (001)
- Crystal Effects**
- Transparent Effects**
- Crystal AB (001 AB)
- Crystal Bermuda Blue P (001 BB)
- Crystal Golden Shadow (001 GSHA)
- Crystal Paradise Shine (001 PARSH)
- Crystal Silver Night (001 SINI)
- Crystal Vitrail Light P (001 VL)

6650 Cubist Pendant



Siz
MM 22,0

- Crystal**
- Crystal (001)
- Colors**
- Plain Colors**
- Light Amethyst (212)
- Light Sapphire (211)
- Crystal Effects**
- Transparent Effects**
- Crystal Golden Shadow (001 GSHA)
- Crystal Moonlight (001 MOL)

¹ For details about the protective coating, please refer to the chapter 'Basic Information.'

6656 Galactic Vertical Pendant

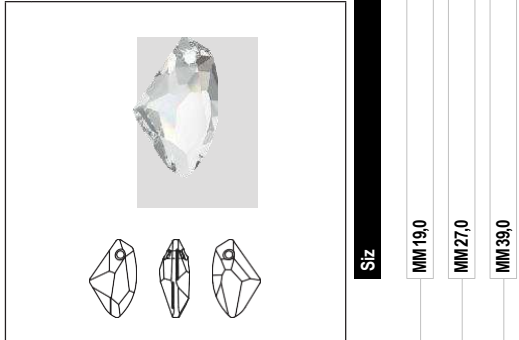

Siz	MM19,0		
	MM27,0		
	MM39,0		

Crystal			
Crystal (001)	■	■	■
Colors			
Plain Colors			
Aquamarine (202)	■	■	
Light Rose (223)	■	■	
Peridot (214)	■	■	
Tanzanite (539)	■	■	
Crystal Effects			
Transparent Effects			
Crystal Bermuda Blue P (001 BB)	■	■	■
Crystal Golden Shadow (001 GSHA)	■	■	■
Crystal Moonlight (001 MOL)	■	■	
Crystal Silver Shade (001 SSHA)	■	■	■

6670 De-Art Pendant

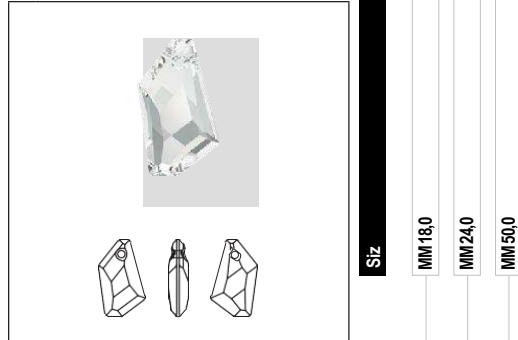

Siz	MM18,0		
	MM24,0		
	MM50,0		

Crystal			
Crystal (001)	■	■	■
Colors			
Plain Colors			
Aquamarine (202)	■	■	
Crystal Effects			
Transparent Effects			
Crystal AB (001 AB)	■	■	
Crystal Bermuda Blue P (001 BB)	■	■	■
Crystal Golden Shadow (001 GSHA)	■	■	■
Crystal Silver Night (001 SINI)	■	■	■

6673 Meteor Pendant

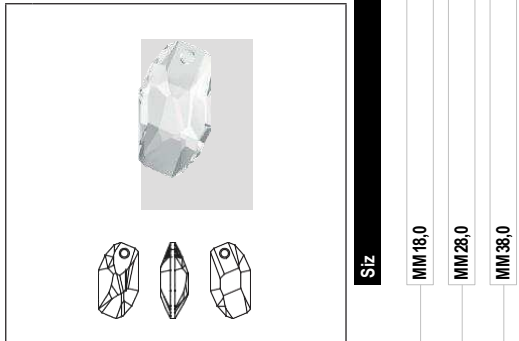

Siz	MM18,0		
	MM28,0		
	MM38,0		

Crystal			
Crystal (001)	■	■	■
Colors			
Plain Colors			
Light Turquoise (263)	■	■	■
Crystal Effects			
Transparent Effects			
Crystal AB (001 AB)	■	■	■
Crystal Golden Shadow (001 GSHA)	■	■	

6680 Cosmic Pendant

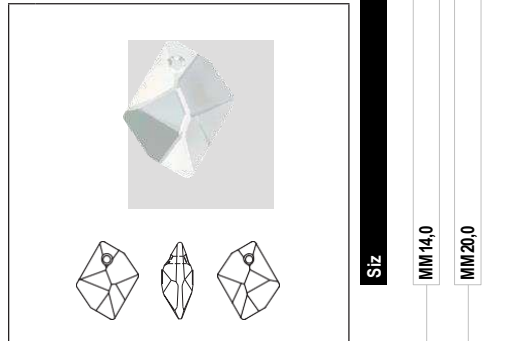

Siz	MM14,0		
	MM20,0		

Crystal			
Crystal (001)	■	■	
Colors			
Plain Colors			
Aquamarine (202)	■	■	
Violet (371)	■	■	
Crystal Effects			
Transparent Effects			
Crystal AB (001 AB)	■	■	
Crystal Golden Shadow (001 GSHA)	■	■	

¹ For details about the protective coating, please refer to the chapter 'Basic Information.'

6685 Graphic Pendant



Siz
MM19,0
MM28,0

- Crystal**
- Crystal (001)
- Colors**
- Plain Colors**
- Amethyst (204)
- Aquamarine (202)
- Denim Blue (266)
- Emerald (205)
- Crystal Effects**
- Transparent Effects**
- Crystal AB (001 AB)
- Crystal Golden Shadow (001 GSHA)

6690 Wing Pendant

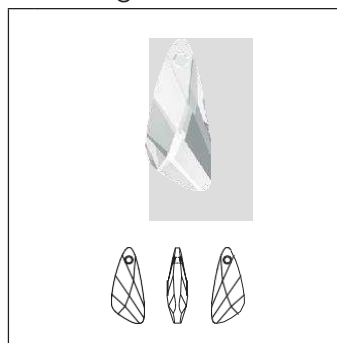

Siz
MM23,0
MM27,0

- Crystal**
- Crystal (001)
- Colors**
- Plain Colors**
- Aquamarine (202)
- Capri Blue (243)
- Tanzanite (539)
- Crystal Effects**
- Transparent Effects**
- Crystal AB (001 AB)
- Crystal Golden Shadow (001 GSHA)
- Crystal Silver Night (001 SINI)

6696 Urban Pendant

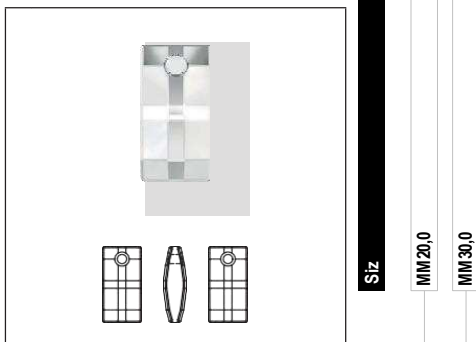

Siz
MM20,0
MM30,0

- Crystal**
- Crystal (001)
- Crystal Effects**
- Transparent Effects**
- Crystal AB (001 AB)
- Crystal Bermuda Blue P (001 BB)
- Crystal Golden Shadow (001 GSHA)
- Crystal Silver Night (001 SINI)
- Metallic Effects**
- Crystal CAL V SI P (001 CAVSI)

6704 Snowflake Pendant

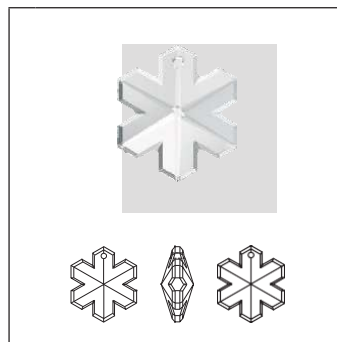

Siz
MM20,0
MM30,0

- Crystal**
- Crystal (001)
- Crystal Effects**
- Transparent Effects**
- Crystal AB (001 AB)
- Crystal Blue Shade (001 BLSH)

¹ For details about the protective coating, please refer to the chapter 'Basic Information.'

6714 Star Pendant

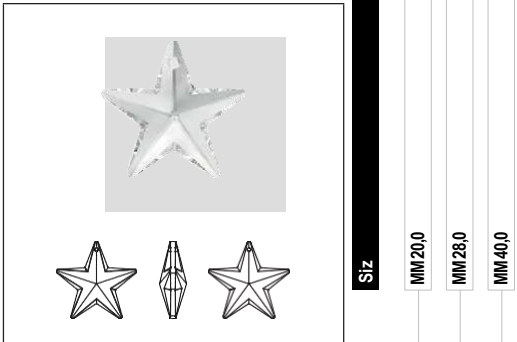

	Siz	MM 20,0	MM 28,0	MM 40,0
Crystal				
Crystal (001)		■	■	■
Colors				
Plain Colors				
Jet (280)		■		
Crystal Effects				
Transparent Effects				
Crystal AB (001 AB)		■	■	■

6721 Starfish Pendant

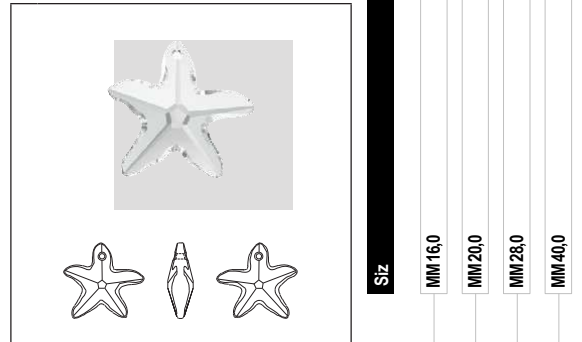

	Siz	MM 16,0	MM 20,0	MM 28,0	MM 40,0
Crystal					
Crystal (001)		■	■	■	■
Colors					
Plain Colors					
Aquamarine (202)		■	■		
Indicolite (379)		■	■		
Crystal Effects					
Transparent Effects					
Crystal AB (001 AB)		■	■	■	■
Crystal Bermuda Blue P (001 BB)		■	■	■	
Crystal Golden Shadow (001 GSHA)		■	■	■	

6722 Moon Pendant

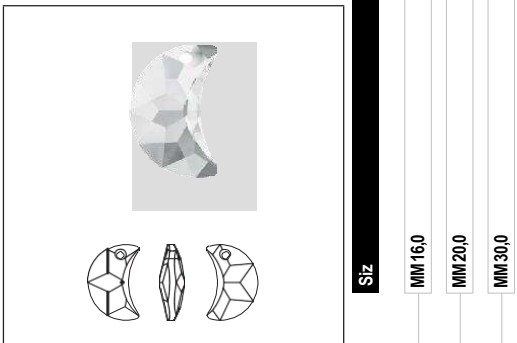

	Siz	MM 16,0	MM 20,0	MM 30,0
Crystal				
Crystal (001)		■	■	■
Crystal Effects				
Transparent Effects				
Crystal AB (001 AB)		■	■	■

6723 Shell Pendant

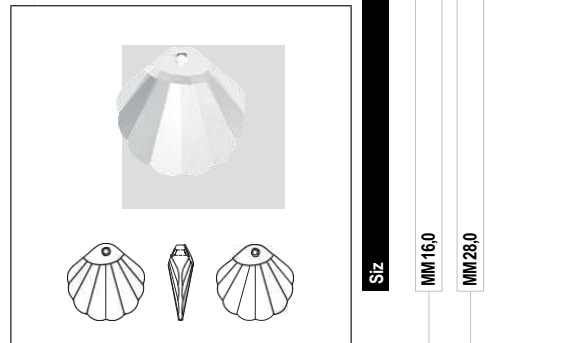

	Siz	MM 16,0	MM 28,0
Crystal			
Crystal (001)		■	■
Colors			
Plain Colors			
Aquamarine (202)		■	
Crystal Effects			
Transparent Effects			
Crystal AB (001 AB)		■	■
Crystal Golden Shadow (001 GSHA)		■	■

¹ For details about the protective coating, please refer to the chapter 'Basic Information.'

6724 Sun Pendant

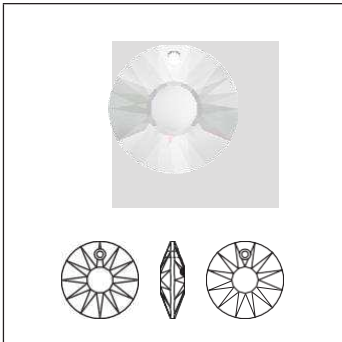

Siz	MM 12,0	MM 19,0	MM 33,0
-----	---------	---------	---------

Crystal

Crystal (001)	■	■	■
Crystal Sahara P (001 SAH)	■	■	■

Crystal Effects

Transparent Effects

Crystal AB (001 AB)	■	■	■
Crystal Bermuda Blue P (001 BB)	■	■	■
Crystal Heliotrope P (001 HEL)	■	■	■
Crystal Silver Night (001 SINI)	■	■	■
Crystal Vitrail Light P (001 VL)	■	■	■
Crystal Vitrail Medium P (001 VM)	■	■	■
Crystal Volcano P (001 VOL)	■	■	■

¹ For details about the protective coating, please refer to the chapter 'Basic Information.'

OCEAN MYSTERIES

DESIGNED BY CÉLINE COUSTEAU

DESIGNER EDITION

Design Story: Above for the sea runs through her veins: Céline Cousteau is a celebrated filmmaker, humanitarian, and environmentalist, as well as the granddaughter of legendary ocean explorer Jacques-Yves Cousteau. She presents her first ever crystal designs for Swarovski, inspired by one of her favorite places, the depths of the ocean. Taking inspiration from nature itself and

leaving its beauty unaltered, her stunningly life-like creatures are not only captivating and spellbinding, they also draw attention toward the mysterious, mostly unseen, and unexplored world beneath the ocean's surface on which all ocean life depends. These mysteries need to be protected for future generations, both above and below the water.

6730 Radiolarian Pendant partly frosted



Size 18x11,5 mm (with cavity)

6730 Radiolarian Pendant partly frosted



Size 34x22 mm (with clearance holes)

DESIGNER EDITION

6730	Size	MM 18,0X 11,5	MM 34,0X 22,0
Crystal			
Crystal (001)		<input checked="" type="checkbox"/>	<input checked="" type="checkbox"/>
Colors			
Plain Colors			
Blush Rose (257)		<input checked="" type="checkbox"/>	<input type="checkbox"/>
Tanzanite (539)		<input checked="" type="checkbox"/>	<input type="checkbox"/>
Opal Colors			
White Opal (234)		<input checked="" type="checkbox"/>	<input type="checkbox"/>
Crystal Effects			
Transparent Effects			
Crystal AB (001 AB)		<input checked="" type="checkbox"/>	<input checked="" type="checkbox"/>
Crystal Bermuda Blue P (001 BB)		<input checked="" type="checkbox"/>	<input checked="" type="checkbox"/>
Crystal Bermuda Blue V P (001 BBV)		<input checked="" type="checkbox"/>	<input checked="" type="checkbox"/>
Crystal Blue Shade (001 BLSH)		<input checked="" type="checkbox"/>	<input checked="" type="checkbox"/>
Crystal Golden Shadow (001 GSHA)		<input checked="" type="checkbox"/>	<input checked="" type="checkbox"/>
Crystal Luminous Green (001 LUMG)		<input checked="" type="checkbox"/>	<input checked="" type="checkbox"/>
Crystal Silver Night (001 SIN)		<input checked="" type="checkbox"/>	<input checked="" type="checkbox"/>
Crystal Silver Night 'V' (001 SINIV)		<input checked="" type="checkbox"/>	<input checked="" type="checkbox"/>
Crystal Silver Shade (001 SSHA)		<input checked="" type="checkbox"/>	<input checked="" type="checkbox"/>

¹ For details about the protective coating, please refer to the chapter 'Basic Information.'

6731 Sea Snail Pendant partly frosted



Size 1.4 mm (with cavity)

6731 Sea Snail Pendant partly frosted



Size 28 mm (with clearance holes)

6731	Siz	
	MM 14,0	MM 28,0
Crystal		
Crystal (001)	■	■
Colors		
Plain Colors		
Blush Rose (257)	■	
Tanzanite (539)	■	
Opal Colors		
White Opal (234)	■	
Crystal Effects		
Transparent Effects		
Crystal AB (001 AB)	■	■
Crystal Bermuda Blue P (001 BB)	■	■
Crystal Bermuda Blue V P (001 BBV)	■	■
Crystal Blue Shade (001 BLSH)	■	■
Crystal Golden Shadow (001 GSHA)	■	■
Crystal Luminous Green (001 LUMG)	■	■
Crystal Silver Night (001 SINI)	■	■
Crystal Silver Night 'V' (001 SINIV)	■	■
Crystal Silver Shade (001 SSHA)	■	■

¹ For details about the protective coating, please refer to the chapter 'Basic Information.'

THE CÉLINE COUSTEAU DESIGNER EDITION FAMILY

1695
10, 14 mm

chapter01 RoundStones
p. 124



1695/S
10, 14 mm

chapter01 RoundStones
p. 124



4195
14, 18,
22 mm

chapter02 FancyStones & Settings
p. 143



4195/S
14, 18,
22 mm

chapter02 FancyStones & Settings
p. 143



6730
18x11.5,
34x22 mm

chapter06 Pendants
p. 348



6731
14, 28 mm

chapter06 Pendants
p. 349

DESIGNER EDITIONS – DISTINCT PACKAGING

This Designer Edition will be labeled with the
"Designer Edition" imprint directly on the packaging.

6734 PureLeafPendant

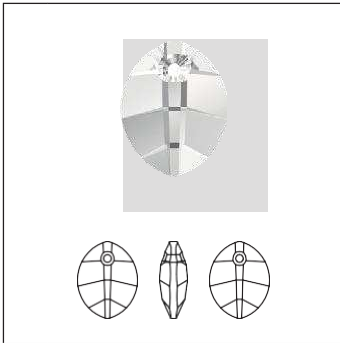

Size 14 mm

6734 PureLeafPendant

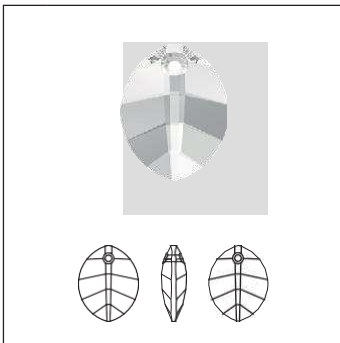

Size 23 mm

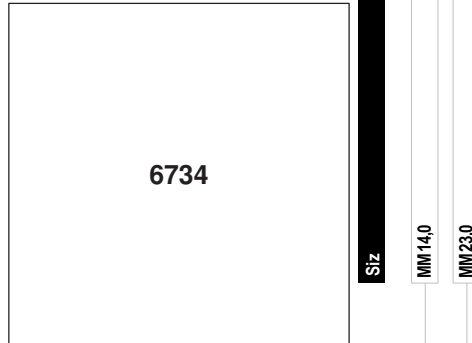

- Crystal**
- Crystal (001)
- Colors**
- Plain Colors
- Fern Green (291)
- Crystal Effects**
- Transparent Effects
- Crystal AB (001 AB)
- Crystal Blue Shade (001 BLSH)
- Crystal Golden Shadow (001 GSHA)
- Crystal Silver Night (001 SINI)

6735 LeafPendant

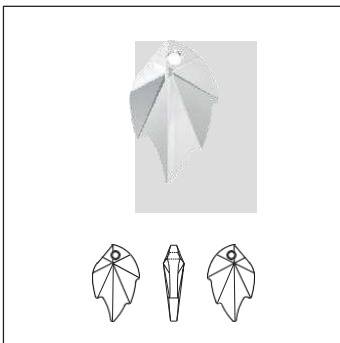

Siz
MM26,0X 16,0

- Crystal**
- Crystal (001)
- Crystal Effects**
- Transparent Effects
- Crystal AB (001 AB)
- Crystal Golden Shadow (001 GSHA)

6744 FlowerPendant

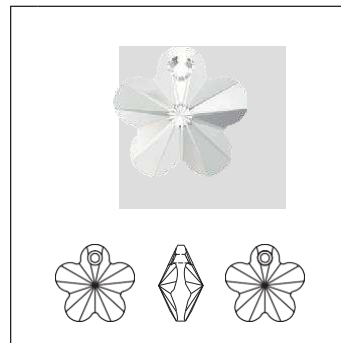

Siz
MM12,0
MM14,0
MM18,0

- Crystal**
- Crystal (001)
- Crystal Effects**
- Transparent Effects
- Crystal AB (001 AB)
- Crystal Golden Shadow (001 GSHA)

6748 Edelweiss Pendant

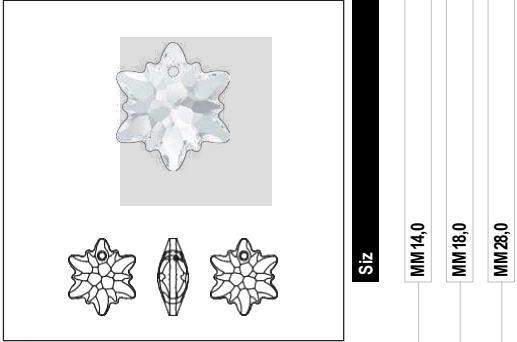

Siz	MM 14,0	MM 18,0	MM 28,0
Crystal			
Crystal (001)	■	■	■
Colors			
Plain Colors			
Amethyst (204)	■	■	■
Aquamarine (202)	■	■	■
Light Siam (227)	■	■	■
Crystal Effects			
Transparent Effects			
Crystal AB (001 AB)	■	■	■
Crystal Blue Shade (001 BLSH)	■	■	■
Crystal Silver Night (001 SINI)	■	■	■

Crystal

Crystal (001)

Colors

Plain Colors

Amethyst (204)

Aquamarine (202)

Light Siam (227)

Crystal Effects

Transparent Effects

Crystal AB (001 AB)

Crystal Blue Shade (001 BLSH)

Crystal Silver Night (001 SINI)

6754 Butterfly Pendant

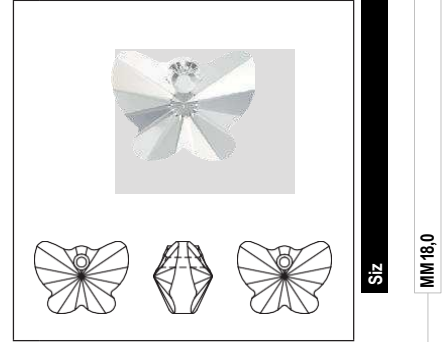

Siz	MM 18,0
Crystal	
Crystal (001)	■
Crystal Effects	
Transparent Effects	
Crystal Golden Shadow (001 GSHA)	■

Crystal

Crystal (001)

Crystal Effects

Transparent Effects

Crystal Golden Shadow (001 GSHA)

6764 Clover Pendant

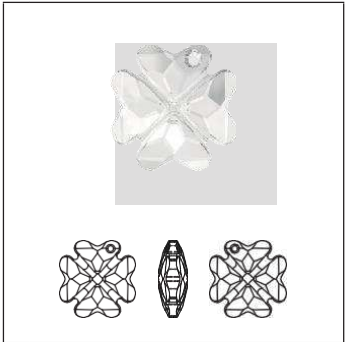

Siz	MM 19,0	MM 23,0
Crystal		
Crystal (001)	■	■
Colors		
Plain Colors		
Emerald (205)	■	■
Crystal Effects		
Transparent Effects		
Crystal AB (001 AB)	■	■
Crystal Golden Shadow (001 GSHA)	■	■

Crystal

Crystal (001)

Colors

Plain Colors

Emerald (205)

Crystal Effects

Transparent Effects

Crystal AB (001 AB)

Crystal Golden Shadow (001 GSHA)

6860

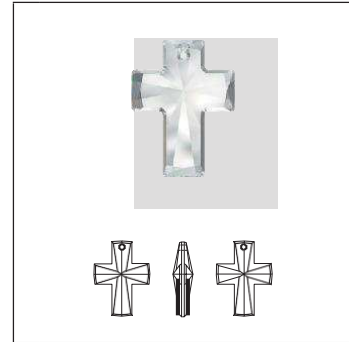

Siz	MM 12,0X 10,0	MM 20,0X 16,0
Crystal		
Crystal (001)	■	■

Crystal

Crystal (001)

6864

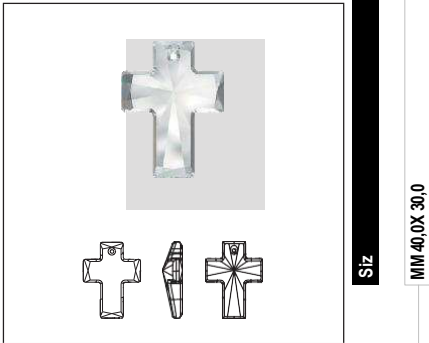

Siz

MM 40,0X 30,0

Crystal

Crystal (001)

Crystal Effects

Transparent Effects

Crystal Aurore Boreale V (001 ABV)

6866

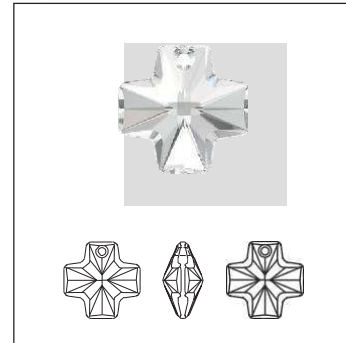

Siz

MM 20,0

Crystal

Crystal (001)

Crystal Effects

Transparent Effects

Crystal AB (001 AB)

Crystal Golden Shadow (001 GSHA)

Crystal Heliotrope (001 HEL)

6867 Greek Cross Pendant

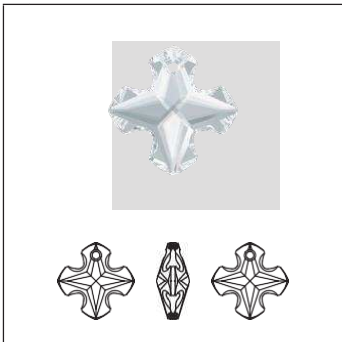

Siz

MM 14,0

MM 18,0

MM 28,0

Crystal

Crystal (001)

Colors

Plain Colors

Jet (280)

Crystal Effects

Transparent Effects

Crystal AB (001 AB)

Crystal Bermuda Blue P (001 BB)

Crystal Golden Shadow (001 GSHA)

Crystal Silver Night (001 SINI)

Crystal Vitrail Medium P (001 VM)

¹ For details about the protective coating, please refer to the chapter 'Basic Information.'

TRIBUTE TO TRIBE COLLECTION DESIGNED BY CÉLINE COUSTEAU

DESIGNER EDITION

Inspired by her project Tribes on the Edge and through experiences with indigenous tribes in the Brazilian rainforest, environmentalist and humanitarian Céline Cousteau presents her second Designer Edition for Swarovski: pristine tribal symbols that celebrate the interconnection of mankind to nature. The *Oval Tribe Fancy Stone* stands for a new design ethos where global references and mediums are mixed and matched to create a

contemporary appreciation of the remote and unknown. The *Rhombus Tribe Fancy Stone* is a beautiful rendition of a tribal inspired design, inviting us to embrace a multi-cultural future. As an international, almost universal symbol, the cross is deeply rooted in every culture. As such, the Cross Tribe Pendant incorporates the message of social responsibility, mutual respect and pluralism.

6868 Cross Tribe Pendant

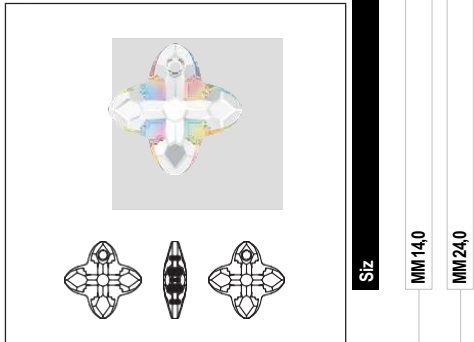
Crystal Effects

Transparent Effects

Crystal Aurore Boreale Z (001 ABZ)

Color Effects

Metallic Effects

Aquamarine Metallic Blue Z (202 MEBLZ)

Graphite Light Chrome Z (253 LTCHZ)

Light Siam Met Lt Gold Z (227 MLGDZ)

Peridot Scarabaeus Green Z (214 SCGRZ)

Topaz Dorado Z (203 DORZ)

Size

MM140

MM240

THE CÉLINE COUSTEAU DESIGNER EDITION FAMILY

- 
4926 Oval Tribe
Fancy Stone
14x10, 19x14 mm
 chapter02 Fancy Stones & Settings
p. 207

- 
4926/S
14x10, 19x14 mm
 chapter02 Fancy Stones & Settings
p. 207

- 
4927 Rhombus Tribe
Fancy Stone
14x12, 19x17 mm
 chapter02 Fancy Stones & Settings
p. 208



- 
4927/S
14x12, 19x17 mm
 chapter02 Fancy Stones & Settings
p. 208

- 
6868 Cross Tribe Pendant
14, 24 mm
 chapter06 Pendants
p. 355

DESIGNER EDITIONS – DISTINCT PACKAGING

This Designer Edition will be labeled with the "Designer Edition" imprint directly on the packaging.

6871 Buddha Pendant

Siz

MM 28,0X 19,8

Crystal

- Crystal (001)

Crystal Effects

Transparent Effects

- Crystal AB (001 AB)
- Crystal Blue Shade (001 BLSH)
- Crystal Golden Shadow (001 GSHA)
- Crystal Luminous Green (001 LUMG)
- Crystal Silver Night (001 SINI)

KAPUTT DESIGNED BY JEAN PAUL GAULTIER

DESIGNER EDITION

Design Story: While the whole world strives for perfection, Swarovski discovers the beauty of imperfection, guided and inspired by none other than design legend Jean Paul Gaultier. Together with Swarovski's own trend, design, and product management experts, Gaultier developed the spectacular Kaputt Collection exclusively for Swarovski. As its name, the German word for "broken," already suggests, the collection presents a technological innovation that deliberately breaks with convention. It celebrates the appeal of being different and unpredictable, which, according to the designer, is much more exciting than the precise and perfect.

Description: Broken and raw, but elegant at the same time, the Kaputt design captivates with distinctively irregular, partly unpolished, or frosted surfaces that give it an all-natural, almost meteoritic appearance. It comes in rich, shimmering metallic colors as well as classics such as Crystal and Crystal Golden Shadow, and boasts the famous Jean Paul Gaultier logo as a laser engraving.

Look: In a world of flawless, artificial beauty, Kaputt mirrors the attractiveness of irregular, natural surfaces for a down-to-earth look that is both rock and chic.

DESIGNER EDITION

6911 Kaputt Oval Pendant

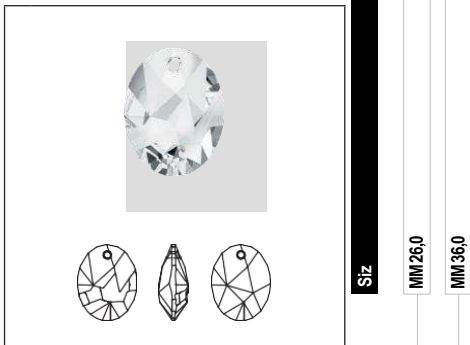

Crystal

Crystal (001)

Crystal Effects

Transparent Effects

Crystal Silver Night (001 SINI)

Crystal Volcano P (001 VOL)

Metallic Effects

Crystal Metallic Blue (001 METBL)

Crystal Scarabaeus Green (001 SCGR)

6913 Kaputt Pendant



Crystal

Crystal (001)

Crystal Effects

Transparent Effects

Crystal Silver Night (001 SINI)

Crystal Volcano P (001 VOL)

Metallic Effects

Crystal Metallic Blue (001 METBL)

Crystal Scarabaeus Green (001 SCGR)

*** designed by Jean Paul Gaultier

¹ For details about the protective coating, please refer to the chapter 'Basic Information.'

THE KAPUTT DESIGNER EDITION FAMILY



4921 Kaputt Oval
Fancy Stone
23x18, 29x22.5 mm

chapter02 Fancy Stones & Settings
p. 205



4925 Kaputt Baguette
Fancy Stone
23x9, 29x11.5 mm

chapter02 Fancy Stones & Settings
p. 206



4921/S
23x18, 29x22.5 mm

chapter02 Fancy Stones & Settings
p. 205



4925/S
23x9, 29x11.5 mm

chapter02 Fancy Stones & Settings
p. 206



4923 Kaputt Fancy Stone
28x24, 38x33 mm

chapter02 Fancy Stones & Settings
p. 205



6911 Kaputt Oval Pendant
26, 36 mm

chapter06 Pendants
p. 356



4923/S
28x24, 38x33 mm

chapter02 Fancy Stones & Settings
p. 205



6913 Kaputt Pendant
28, 40 mm

chapter06 Pendants
p. 356

DESIGNER EDITIONS – DISTINCT PACKAGING

This Designer Edition will be labeled with the
“Designer Edition” imprint directly on the packaging.

YOKO ONO

DESIGNER EDITION

Yoko Ono is a multimedia artist whose thought-provoking work challenges people's understanding of art and the world around them. Her work as a conceptualist has encompassed performance, instructions, film, music, writing, and now jewelry inspiration for Swarovski.

Born in Tokyo in 1933, she moved to New York in 1953, where she became part of the city's vibrant avant-garde scene. She went on to perform and exhibit what have now become legendary works

in the history of contemporary art, including her famous 1969 collaboration, *Bed-In*, with husband John Lennon.

She has had numerous exhibitions in museums, and in 2009, received the Golden Lion for Lifetime Achievement from the Venice Biennale. In 2011 Ono was honored with the prestigious 8th Hiroshima Art Prize for her dedicated peace activism, and in 2012 received the Oskar Kokoschka Prize in Vienna.

THE COOPERATION

A memorable key-shaped crystal pendant, inspired by Yoko Ono, has been designed for Swarovski. The design itself is a technical masterpiece and tells us a wonderful story around the symbol of the key.

THE STORY

**"Imagine a key that unlocks the door
to the forest with its secrets,
to the sky with its peacefulness,
to the universe with its infinity,
to a future with the promise of a better life."**

Yoko Ono

This concept by Yoko Ono has been created as a crystal "KEY TO OPEN THE FOREST" exclusively for our Swarovski collection. It embodies the spirits of earth and sky, and reflects the multiple colors of nature. "Make a promise to a tree. Ask it to be passed on

to other trees." When you wear it you will be sharing Yoko's dream of peaceful interaction with the world around you. "Whisper your dream to a cloud. Ask the cloud to remember it."

6919 KeyPendant

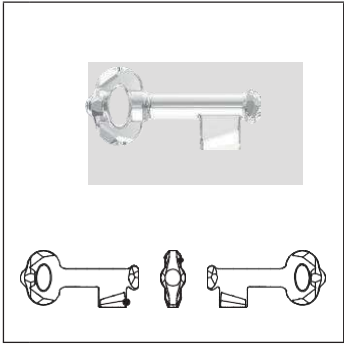

	Siz	
	MM 30,0	MM 50,0
Crystal		
Crystal (001)	■	■
Colors		
Plain Colors		
Indian Sapphire (217)	■	
Crystal Effects		
Transparent Effects		
Crystal AB (001 AB)	■	■
Crystal Golden Shadow (001 GSHA)	■	
Crystal Silver Night (001 SINI)	■	■
Crystal Silver Shade (001 SSHA)	■	

DESIGNER EDITIONS – DISTINCT PACKAGING

This Designer Edition will be labeled with the "Designer Edition" imprint directly on the packaging.

GROWING CRYSTAL

DESIGNED BY IRIS VAN HERPEN

DESIGNER EDITION

Iris van Herpen boldly envisions the future of fashion. For Swarovski's Designer Edition Series, van Herpen imagined two pendants inspired by the creative power of nature. The first, Growing Crystal Rhombus, pays homage to the fractured and fissured elegance of crystals shaped by tectonic forces. The second, Growing Crystal Rectangle, resembles the cross section of a druse crystal in both brilliance and complexity. In each instance, van Herpen highlighted the metamorphosis of crystalline forms under the influence of time: "For beauty yet becoming."

In addition to the pendants she created for the Designer Edition Series, the collaboration with van Herpen also triggered Swarovski to create special 3D Studs, which make it simple to achieve eye-catching relief. Available in three heights, three different plating options, two different cuts, and twenty color and effect options, they are ideal for adding texture and depth to garments for added design freedom.

6925 Growing Crystal Rectangle Pendant

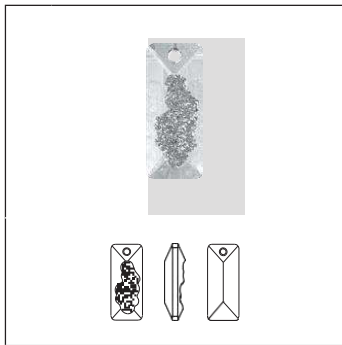

Size 26mm*

6925 Growing Crystal Rectangle Pendant

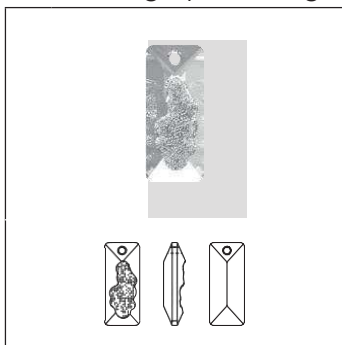

Size 36mm*

6925		Size	
		MM 26,0	MM 36,0
Crystal			
<input type="checkbox"/>	Crystal (001)	<input type="checkbox"/>	<input type="checkbox"/>
Colors			
Plain Colors			
<input type="checkbox"/>	Jet (280)	<input type="checkbox"/>	<input type="checkbox"/>
Crystal Effects			
Transparent Effects			
<input type="checkbox"/>	Crystal AB (001 AB)	<input type="checkbox"/>	<input type="checkbox"/>
<input type="checkbox"/>	Crystal Bermuda Blue P (001 BB)	<input type="checkbox"/>	<input type="checkbox"/>
<input type="checkbox"/>	Crystal Golden Shadow (001 GSHA)	<input type="checkbox"/>	<input type="checkbox"/>
<input type="checkbox"/>	Crystal Silver Night (001 SINI)	<input type="checkbox"/>	<input type="checkbox"/>
<input type="checkbox"/>	Crystal Vitrail Light P (001 VL)	<input type="checkbox"/>	<input type="checkbox"/>

*Art. 6925 in size 26 mm and 36 mm "with cavity" (decorative only)

† For details about the protective coating, please refer to the chapter 'Basic Information.'

6926 Growing Crystal Rhombus Pendant

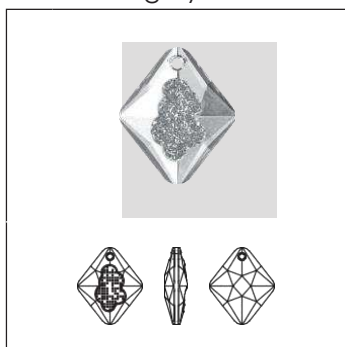

Size 26mm*

6926 Growing Crystal Rhombus Pendant

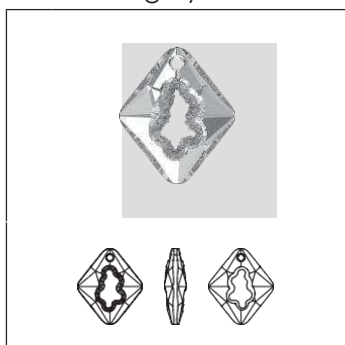

Size 36mm**

6926

	Siz		MM 26,0		MM 36,0
Crystal					
<input type="checkbox"/>	Crystal (001)	<input type="checkbox"/>	<input type="checkbox"/>	<input type="checkbox"/>	<input type="checkbox"/>
Colors					
Plain Colors					
<input type="checkbox"/>	Jet (280)	<input type="checkbox"/>	<input type="checkbox"/>	<input type="checkbox"/>	<input type="checkbox"/>
Crystal Effects					
Transparent Effects					
<input type="checkbox"/>	Crystal AB (001 AB)	<input type="checkbox"/>	<input type="checkbox"/>	<input type="checkbox"/>	<input type="checkbox"/>
<input type="checkbox"/>	Crystal Bermuda Blue P (001 BB)	<input type="checkbox"/>	<input type="checkbox"/>	<input type="checkbox"/>	<input type="checkbox"/>
<input type="checkbox"/>	Crystal Golden Shadow (001 GSHA)	<input type="checkbox"/>	<input type="checkbox"/>	<input type="checkbox"/>	<input type="checkbox"/>
<input type="checkbox"/>	Crystal Silver Night (001 SINI)	<input type="checkbox"/>	<input type="checkbox"/>	<input type="checkbox"/>	<input type="checkbox"/>
<input type="checkbox"/>	Crystal Vitrail Light P (001 VL)	<input type="checkbox"/>	<input type="checkbox"/>	<input type="checkbox"/>	<input type="checkbox"/>

* Art. 6926 in size 26 mm "with cavity" (decorative only)

** Art. 6926 in size 36 mm "with decorative clearance hole"

† For details about the protective coating, please refer to the chapter "Basic Information."

PRODUCT DETAILS

Article Size	Packing Unit = Minimum Order Quantity in Pieces	Average Net Weight in Gram per Packing Unit Crystal (001)	Average Gross Weight in Gram per Packing Unit Crystal (001)
6000			
11x5.5 mm	288	99.8	123.1
13x6.5 mm	288	156.9	197.5
15x7.5 mm	144	129.8	153.4
22x11 mm	48	129.4	151.3
6002			
10x7 mm	144	91.4	109.3
15x11.5 mm	72	175.4	197.3
6007			
7x4 mm	360	46.7	55.8
9x5 mm	288	77.1	104.2
6010			
11x5.5 mm	144	57.4	75.9
13x6.5 mm	144	91.1	109.0
17x8.5 mm	36	57.3	77.2
21x10.5 mm	24	66.3	83.4
6012			
11x10 mm	144	94.2	120.0
15.4x14 mm	72	126.0	157.3
6015			
17 mm	72	93.2	111.5
21 mm	48	105.9	129.3
50 mm	6	173.7	222.8
6017/G			
30 mm	12	25.0	45.6
56 mm	6	67.5	91.4
6020			
18 mm	36	49.7	72.1
30 mm	12	74.3	95.5
37 mm	6	76.4	82.5
6022			
14 mm	72	77.2	97.0
24 mm	24	133.9	155.5
6028			
8 mm	144	31.8	40.9
10 mm	192	71.0	97.7
12 mm	108	68.9	92.9
18 mm	72	146.5	170.3
6039			
25 mm	24	88.4	117.5
38 mm	9	92.7	123.8
6040			
20 mm	72	66.3	92.8
30 mm	30	85.4	116.4
40 mm	6	41.7	61.4
6041			
18 mm	30	38.3	63.1
28 mm	12	57.9	80.2
38 mm	6	65.3	88.3

Article Size	Packing Unit = Minimum Order Quantity in Pieces	Average Net Weight in Gram per Packing Unit Crystal (001)	Average Gross Weight in Gram per Packing Unit Crystal (001)
6049			
20 mm	72	170.5	200.4
30 mm	24	166.7	209.2
6090			
16x11 mm	72	55.8	75.8
22x15 mm	48	102.2	136.7
6100			
24x12 mm	36	54.5	83.9
6106			
16 mm	144	129.9	158.3
22 mm	96	208.1	248.5
28 mm	36	171.8	201.1
38 mm	9	91.1	121.6
6128			
8 mm	144	23.2	34.0
10 mm	144	52.3	80.0
12 mm	144	81.8	101.3
6150			
30 mm	48	140.6	174.5
6210			
12 mm	144	67.8	90.9
17 mm	72	98.8	122.0
6215			
18 mm	72	183.2	210.5
6225			
10 mm	144	48.3	68.4
18 mm	24	41.6	59.0
28 mm	24	160.7	206.2
6228			
10.3x10 mm	288	124.6	152.6
14.4x14 mm	144	181.4	210.5
18x17.5 mm	72	188.0	211.7
28 mm	16	124.0	158.7
40 mm	6	137.9	169.2
6240			
12 mm	108	63.3	83.5
17 mm	72	116.4	137.0
27 mm	24	142.6	147.8
6261			
17 mm	48	48.2	76.6
27 mm	20	77.0	102.6
36 mm	12	112.5	135.3
6262			
17 mm	48	67.9	91.9
26 mm	16	74.0	92.5
34 mm	6	53.7	80.3

Article Size	Packing Unit = Minimum Order Quantity in Pieces	Average Net Weight in Gram per Packing Unit Crystal (001)	Average Gross Weight in Gram per Packing Unit Crystal (001)
6264			
18 mm	48	93.4	109.1
28 mm	16	93.7	118.2
6320			
14 mm	96	48.2	70.0
19 mm	48	61.6	78.3
27 mm	24	89.1	101.3
6328			
6 mm	360	78.5	89.5
8 mm	288	153.2	173.2
6401			
8 mm	288	106.8	123.8
12 mm	144	164.9	182.7
6428			
6 mm	720	80.1	89.5
8 mm	144	37.4	46.7
12 mm	144	121.8	141.6
6430			
8 mm	72	23.7	42.1
10 mm	48	31.7	51.9
14 mm	24	40.9	61.6
6460			
20 mm	72	60.3	83.1
6465			
13.5x6 mm	72	40.3	61.4
25x7 mm	36	51.9	75.6
38x10 mm	24	89.3	125.7
6480			
18 mm	48	42.7	64.1
28 mm	36	101.6	130.5
39 mm	16	105.6	133.7
6530			
12 mm	96	55.7	73.0
20 mm	48	67.7	87.8
30 mm	24	74.6	95.3
65M001			
9 mm	96	15.9	34.4
11.5 mm	48	11.7	30.0
14 mm	24	7.9	23.2
65M002			
3.5 mm	48	2.7	18.0
4 mm	24	2.1	17.3
6532			
21 mm	24	17.9	38.5
31.5 mm	20	33.1	55.7
44 mm	16	55.0	88.4

Article Size	Packing Unit = Minimum Order Quantity in Pieces	Average Net Weight in Gram per Packing Unit Crystal (001)	Average Gross Weight in Gram per Packing Unit Crystal (001)
6533			
17.5 mm	36	11.6	31.8
23 mm	24	14.6	35.4
33 mm	12	22.7	43.4
6565			
18 mm	36	43.6	64.2
22 mm	24	54.9	75.0
6621			
18 mm	72	192.8	212.7
28 mm	24	190.8	217.8
6628			
8 mm	288	72.6	72.8
12 mm	144	101.6	126.9
16 mm	72	128.2	155.1
6650			
22 mm	24	101.5	119.7
6656			
19 mm	48	72.3	94.2
27 mm	30	126.1	159.6
39 mm	6	61.8	82.0
6670			
18 mm	72	68.4	104.6
24 mm	48	105.5	161.9
50 mm	6	104.7	126.8
6673			
18 mm	48	59.7	80.7
28 mm	20	89.0	112.2
38 mm	6	69.5	87.1
6680			
14 mm	144	118.7	145.1
20 mm	72	167.5	191.1
6685			
19 mm	48	104.5	127.4
28 mm	24	168.7	175.4
6690			
23 mm	36	54.5	88.6
27 mm	36	99.4	130.5
6696			
20 mm	24	53.5	70.6
30 mm	10	59.6	83.3
6704			
20 mm	48	131.4	155.0
30 mm	16	128.1	164.1

Article Size	Packing Unit = Minimum Order Quantity in Pieces	Average Net Weight in Gram per Packing Unit Crystal (001)	Average Gross Weight in Gram per Packing Unit Crystal (001)
6714			
20 mm	48	48.2	73.1
28 mm	24	112.5	156.1
40 mm	6	56.1	87.4
6721			
16 mm	72	105.1	131.7
20 mm	30	76.8	113.6
28 mm	12	66.3	93.7
40 mm	6	83.9	113.5
6722			
16 mm	72	63.9	87.2
20 mm	48	64.3	102.4
30 mm	20	113.8	131.3
6723			
16 mm	96	176.8	215.0
28 mm	18	126.6	160.3
6724			
12 mm	144	104.4	131.7
19 mm	45	127.7	157.8
33 mm	6	79.9	105.8
6730			
18x11.5 mm	24	31.7	52.3
34x22 mm	8	55.6	76.7
6731			
14 mm	36	35.1	64.0
28 mm	8	76.4	98.2
6734			
14 mm	108	82.6	104.2
23 mm	30	88.5	111.6
6735			
26x16 mm	30	73.3	110.0
6744			
12 mm	144	118.7	145.4
14 mm	144	172.9	204.5
18 mm	72	174.8	207.2
6748			
14 mm	72	65.3	90.0
18 mm	48	88.3	110.2
28 mm	18	115.7	145.4
6754			
18 mm	72	217.0	248.3
6764			
19 mm	48	114.5	131.8
23 mm	24	95.76	138.4
6860			
12x10 mm	144	31.2	54.5
20x16 mm	72	48.2	73.1

Article Size	Packing Unit = Minimum Order Quantity in Pieces	Average Net Weight in Gram per Packing Unit Crystal (001)	Average Gross Weight in Gram per Packing Unit Crystal (001)
6864			
40x30 mm	9	109.2	142.2
6866			
20 mm	72	249.5	272.8
6867			
14 mm	72	55.7	79.1
18 mm	48	77.7	101.4
28 mm	24	130.2	164.9
6868			
14 mm	36	21.4	39.8
24 mm	15	41.1	58.8
6871			
28 x 19.8mm	10	34.7	57.3
6911			
26 mm	20	141.3	165.3
36 mm	9	150.4	180.5
6913			
28 mm	15	36.9	62.7
40 mm	8	58.2	80.5
6919			
30 mm	36	63.8	88.6
50 mm	6	43.6	66.5
6925			
26 mm	12	25.0	45.8
36 mm	6	32.0	56.8
6926			
26 mm	15	50.8	75.5
36 mm	8	58.7	80.5



FLAT BACKS NO HOTFIX

Flat Backs No Hotfix are loose crystal elements backed with platinum foiling for extra brilliance and protection. These Flat Backs are easy to apply to a variety of carrier materials using standard one- or two-component glues. They are available in a multitude of sizes, colors, shapes, and cuts.

The most innovative single item in this product group is art. 2088 XIRIUS Rose, with the most progressive and unique cut on the market: multilayer cut technology

creates the inspiring XIRIUS star design. Superior shine and rich, well-balanced refraction of light redefine the market standard.



Swarovski's outstanding quality in crystal elements is underlined by the highest precision in table size and diameter.

Communication on Product-Assortment changes*

IMPORTANT INFORMATION ON ASSORTMENT ADJUSTMENTS

We would kindly like to inform you about overall portfolio streamlining as well as discontinuations of selected product lines, effective as of November 23rd, 2020.





















































































In order to allow you sufficient time to prepare, upcoming changes are already visible in our B2B e-commerce platform. During this transition phase the collection has been marked with the following caption:

Caption - SUMMARY	
	OUT OF ASSORTMENT
	CHANGES IN THE ASSORTMENT
	NO CHANGES IN THE ASSORTMENT

Caption - MATRIX	
	OUT OF ASSORTMENT
	FUTURE MADE TO ORDER ITEM - MTO
	FUTURE MADE TO STOCK ITEM - MTS

*ASSORTMENT WILL BE VALID DURING THE TRANSITION PHASE: **NOV 23rd 2020 – March 31st 2021**
SMALL CHANGES CAN ACCURE DURING THIS TRANSITION PHASE

SUMMARY

1 2	2000 SS 3, 4	1 2	COREASSORTMENT 2300 8x4.8, 10x6 mm	1 2	2555 8x2.6, 12x4, 15x5 mm
 	2006 10, 12, 14, 16 mm	 	2303 8x5, 14x9 mm	 	2570 50x16 mm
 	2019 4, 5, 6 mm	 	2304 6x1.7, 10x2.8, 14x3.9 mm	 	2585 8, 10 mm
 	2034 SS 10, 20, 48	 	COREASSORTMENT 2400 2.2, 3, 4, 6, 10 mm	 	2602 8x5.5, 14x10 mm
 	2035 6, 10, 14, 20, 30, 40 mm	 	2402 4, 6, 10 mm	 	2709 10x6, 13x8 mm
 	COREASSORTMENT 2058 SS 5, 6, 7, 8, 9, 10	 	2403 4, 6, 10 mm	 	2711 3, 3 mm
 	2072 8, 10, 12 mm	 	2419 4, 5, 6 mm	 	2714 6, 10 mm
 	COREASSORTMENT 2088 SS 12, 14, 16, 20, 24, 30, 34, 40, 48	 	2420 10, 25 mm	 	2716 5 mm
 	2088/1 SS 16, 20, 34	 	2471 5, 7, 10 mm	 	2720 7.5, 9, 12.5 mm
 	2196/4 30x22.7 mm	 	2483 10, 25 mm	 	2738 10x5, 12x6 mm
 	COREASSORTMENT 2200 4x2, 8x4 mm	 	2493 8, 10, 20 mm	 	2739 5.8x5.3, 7x6.5 mm
 	2201 8x3.5, 14x6 mm	 	2494 6, 8 mm	 	2510 3.7x1.9 mm
 	2204 6x4.8, 10x8 mm	 	2520 8x6, 10x8, 14x10 mm	 	2540 7x5.5 mm
 	2205 7.5, 10, 14 mm	 	2364 6x3.7, 10x6, 14x8.5 mm	 	2408/4 4, 6, 8 mm
 	2208/4 8x4.5, 10x5.5 mm	 	2365 6x3.7, 10x6, 14x8.5 mm		
 	2308/4 8x5, 10x6 mm				

1 Top view 2 Side view

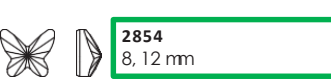
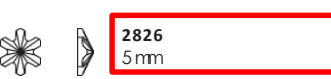
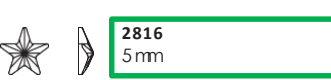
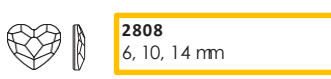
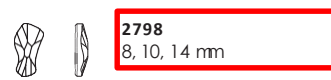
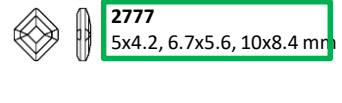
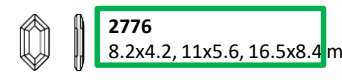
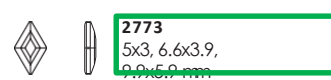
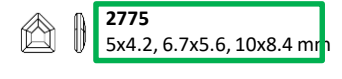
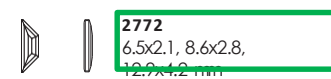
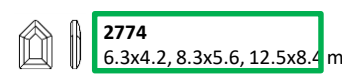
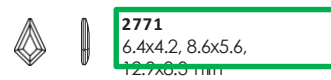
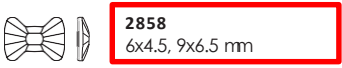
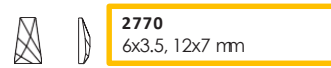
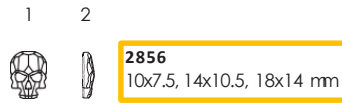
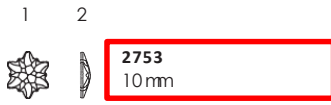

SUMMARY

2000 Rose Flat Back

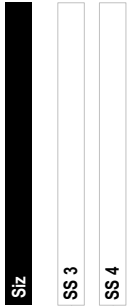
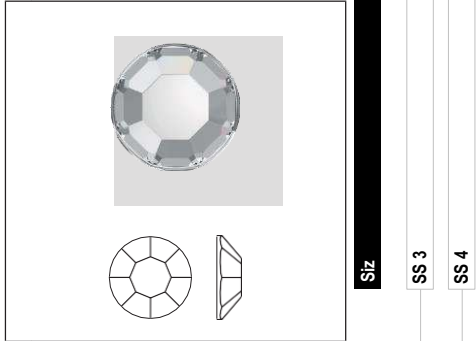

Crystal

Crystal F (001)

Colors

Plain Colors

Amethyst F (204)

Aquamarine F (202)

Black Diamond F (215)

Indian Siam F (327)

Jet (280)

Jonquil F (213)

Light Colorado Topaz F (246)

Light Rose F (223)

Montana F (207)

Peridot F (214)

Smoked Topaz F (220)

Crystal Effects

Transparent Effects

Crystal AB F (001 AB)

Crystal Golden Shadow F (001 GSHA)

Crystal Silver Shade F (001 SSHA)

Metallic Effects

Crystal Metallic Light Gold F (001 MLGLD)

Crystal Rose Gold F (001 ROGL)

Color Effects

Jet Hematite F (280 HEM)

2006 Rivoli Flat Back

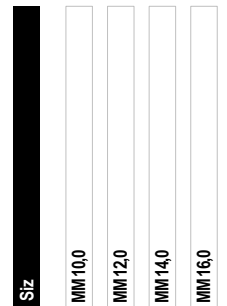
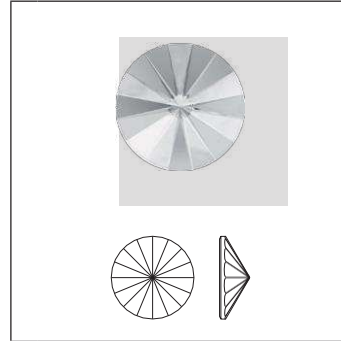

Crystal

Crystal F (001)

2019 ROUND SPIKE FLAT BACK



Siz	MM 4,0X 4,0	MM 5,0X 5,0	MM 6,0X 6,0
-----	-------------	-------------	-------------

Crystal

Crystal F (001)	■	■	■
-----------------	---	---	---

Crystal Effects

Transparent Effects

Crystal AB F (001 AB)	■	■	■
-----------------------	---	---	---

Crystal Blue Shade F (001 BLSH)	■	■	■
---------------------------------	---	---	---

Crystal Golden Shadow F (001 GSHA)	■	■	■
------------------------------------	---	---	---

Crystal Volcano F (001 VOL)	■	■	■
-----------------------------	---	---	---

Color Effects

Black Diamond Shimmer F (215 SHIM)	■	■	■
------------------------------------	---	---	---

Light Topaz Shimmer F (226 SHIM)	■	■	■
----------------------------------	---	---	---

¹ Coated on faceted side.

2034 Concise Flat Back

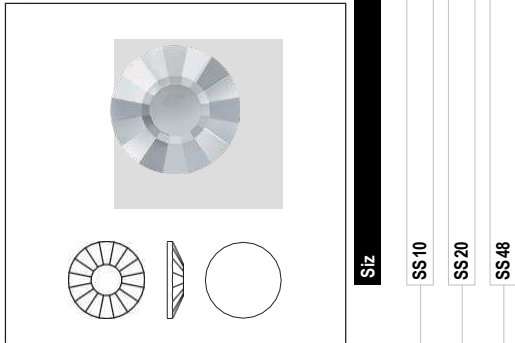

Siz SS 10 SS 20 SS 48

Crystal

Crystal F (001)

Colors

Plain Colors

Jet F (280)

Light Siam F (227)

Crystal Effects

Transparent Effects

Crystal AB F (001 AB)

Crystal Golden Shadow F (001 GSHA)

Metallic Effects

Crystal Light Chrome F (001 LTCH)

Crystal Patina

Crystal Black Patina F (001 BLAPA)

Crystal Rose Patina F (001 ROSPA)

Color Effects

Light Siam AB F (227 AB)

2035 Chessboard Circle Flat Back

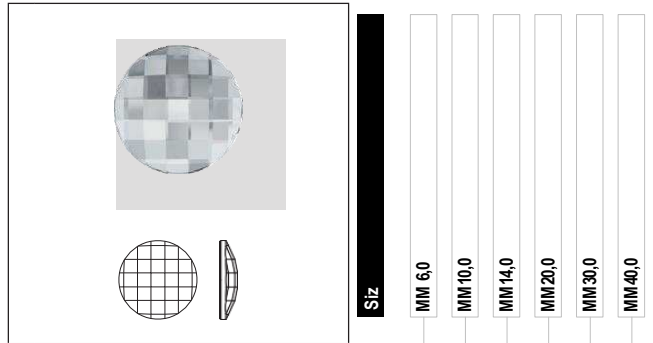

Siz MM 6,0 MM 10,0 MM 14,0 MM 20,0 MM 30,0 MM 40,0

Crystal

Crystal F (001)

Colors

Plain Colors

Jet (280)

Crystal Effects

Transparent Effects

Crystal AB F (001 AB)

Crystal Golden Shadow F (001 GSHA)

Metallic Effects

Crystal CAL V SI (001 CAVSI)

¹ Coated on faceted side.

CORE ASSORTMENT

2058 XILION Rose Enhanced

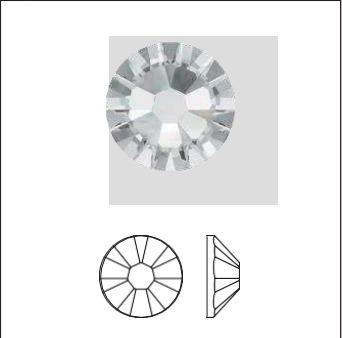

Size	SS 5	SS 6	SS 7	SS 8	SS 9	SS 10
------	------	------	------	------	------	-------

Crystal

Crystal F (001)	■	■	■	■	■	■
-----------------	---	---	---	---	---	---

Colors

Plain Colors

Amethyst F (204)	■	■	■	■	■	■
Aquamarine F (202)	■	■	■	■	■	■
Black Diamond F (215)	■	■	■	■	■	■
Blue Zircon F (229)	■	■	■	■	■	■
Blush Rose F (257)	■	■	■	■	■	■
Burgundy F (515)	■	■	■	■	■	■
Capri Blue F (243)	■	■	■	■	■	■
Chrysolite F (238)	■	■	■	■	■	■
Citrine F (249)	■	■	■	■	■	■
Cobalt F (369)	■	■	■	■	■	■
Dark Indigo F (288)	■	■	■	■	■	■
Denim Blue F (266)	■	■	■	■	■	■
Emerald F (205)	■	■	■	■	■	■
Erinite F (360)	■	■	■	■	■	■
Fern Green F (291)	■	■	■	■	■	■
Fuchsia F (502)	■	■	■	■	■	■
Graphite F (253)	■	■	■	■	■	■
Greige F (284)	■	■	■	■	■	■
Hyacinth F (236)	■	■	■	■	■	■
Indian Pink F (289)	■	■	■	■	■	■
Indian Siam F (327)	■	■	■	■	■	■
Iris F (219)	■	■	■	■	■	■
Jet (280)	■	■	■	■	■	■
Jet F (280)	■	■	■	■	■	■
Jonquil F (213)	■	■	■	■	■	■
Light Amethyst F (212)	■	■	■	■	■	■
Light Colorado Topaz F (246)	■	■	■	■	■	■
Light Peach F (362)	■	■	■	■	■	■
Light Rose F (223)	■	■	■	■	■	■
Light Sapphire F (211)	■	■	■	■	■	■
Light Siam F (227)	■	■	■	■	■	■

2058		Siz						
		SS 5	SS 6	SS 7	SS 8	SS 9	SS 10	
Light Silk F (261)		■		■		■		
Light Topaz F (226)		■		■		■		
Light Turquoise F (263)		■		■		■		
Majestic Blue F (296)		■		■		■		
Montana F (207)		■		■		■		
Olivine F (228)		■	■	■		■		
Padparadscha F (542)		■		■		■		
Peridot F (214)		■		■		■	■	
Provence Lavender F (283)		■		■		■		
Purple Velvet F (277)		■		■		■		
Rose F (209)		■	■	■		■	■	
Rose Peach F (262)		■		■		■		
Ruby F (501)		■		■		■	■	
Sapphire F (206)		■	■	■		■	■	
Scarlet F (276)		■	■	■	■	■		
Siam F (208)		■		■		■	■	
Silk F (391)		■		■		■		
Smoked Topaz F (220)		■		■		■		
Sunflower F (292)		■		■		■		
Tangerine F (259)		■		■		■		
Tanzanite F (539)		■		■		■		
Topaz F (203)		■		■		■		
Vintage Rose F (319)		■		■		■		
Opal Colors								
Air Blue Opal F (285)		■		■		■		
Chrysolite Opal F (294)		■		■		■		
Pacific Opal F (390)		■		■		■		
White Opal F (234)		■		■		■		
Yellow Opal F (231)		■		■		■		
Crystal Effects								
Transparent Effects								
Crystal Antique Pink F (001 ANTP)		■		■		■		
Crystal AB F (001 AB)		■	■	■	■	■	■	
Crystal Blue Shade F (001 BLSH)		■		■		■		
Crystal Copper F (001 COP)		■		■		■		

2058		Siz	SS 5	SS 6	SS 7	SS 8	SS 9	SS 10
	Crystal Golden Shadow F (001 GSHA)		■		■		■	
	Crystal Luminous Green F (001 LUMG)		■		■		■	
	Crystal Meridian Blue F (001 MBLUE)		■		■		■	
	Crystal Moonlight F (001 MOL)		■		■		■	
	Crystal Paradise Shine F (001 PARSH)		■		■		■	
	Crystal Shimmer F (001 SHIM)		■		■		■	
	Crystal Silver Night F (001 SINI)		■		■		■	
	Crystal Silver Shade F (001 SSHA)		■		■		■	
	Crystal Volcano F (001 VOL)		■		■		■	
Metallic Effects								
	Crystal Dorado F (001 DOR)		■		■		■	
	Crystal Iridescent Green F (001 IRIG)		■		■		■	
	Crystal Light Chrome F (001 LTCH)		■		■		■	
	Crystal Metallic Blue F (001 METBL)		■		■		■	
	Crystal Metallic Light Gold F (001 MLGLD)		■		■		■	
	Crystal Metallic Sunshine F (001 METSH)		■		■		■	
	Crystal Rainbow Dark F (001 RABDK)		■		■		■	
	Crystal Rose Gold F (001 ROGL)		■		■		■	
	Crystal Scarabaeus Green F (001 SCGR)		■		■		■	
Color Effects								
	Aquamarine AB F (202 AB)		■		■		■	
	Black Diamond Shimmer F (215 SHIM)		■		■		■	
	Blue Zircon Shimmer F (229 SHIM)		■		■		■	
	Citrine Shimmer F (249 SHIM)		■		■		■	
	Cobalt Shimmer F (369 SHIM)		■		■		■	
	Erinite Shimmer F (360 SHIM)		■		■		■	
	Fuchsia Shimmer F (502 SHIM)		■		■		■	
	Hyacinth Shimmer F (236 SHIM)		■		■		■	
	Jonquil AB F (213 AB)		■		■		■	
	Light Colorado Topaz Shimmer F (246 SHIM)		■		■		■	
	Light Rose AB F (223 AB)		■		■		■	
	Light Rose Shimmer F (223 SHIM)		■		■		■	
	Light Sapphire Shimmer F (211 SHIM)		■		■		■	
	Light Siam AB F (227 AB)		■		■		■	
	Light Siam Shimmer F (227 SHIM)		■		■		■	

2058		Siz	SS 5	SS 6	SS 7	SS 8	SS 9	SS 10
	Light Topaz Shimmer F (226 SHIM)		■		■		■	
	Peridot AB F (214 AB)		■		■		■	
	Peridot Shimmer F (214 SHIM)		■		■		■	
	Rose AB F (209 AB)		■		■		■	
	Rose Peach Shimmer F (262 SHIM)		■		■		■	
	Sapphire AB F (206 AB)		■		■		■	
	Siam Shimmer F (208 SHIM)		■		■		■	
	Silk Shimmer F (391 SHIM)		■		■		■	
	Tangerine Shimmer F (259 SHIM)		■		■		■	
	Tanzanite Shimmer F (539 SHIM)		■		■		■	
	Topaz AB F (203 AB)		■		■		■	
	Topaz Shimmer F (203 SHIM)		■		■		■	
	Jet Hematite (280 HEM)		■		■		■	■
	Jet Hematite F (280 HEM)		■		■		■	■

2072 Rose Cut Flat Back

2072 Rose Cut Flat Back		Siz	MM 8,0	MM 10,0	MM 12,0
	Crystal F (001)		■	■	■

CORE ASSORTMENT

2088 XIRIUS Rose

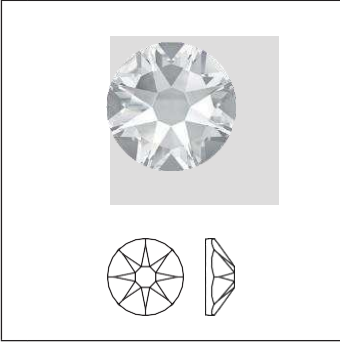

Siz	SS 12	SS 14	SS 16	SS 20	SS 24	SS 30	SS 34	SS 40	SS 48
-----	-------	-------	-------	-------	-------	-------	-------	-------	-------

Crystal

Crystal F (001)

Colors

Plain Colors

- Amethyst F (204)
- Aquamarine F (202)
- Black Diamond F (215)
- Blue Zircon F (229)
- Blush Rose F (257)
- Burgundy F (515)
- Capri Blue F (243)
- Chrysolite F (238)
- Citrine F (249)
- Cobalt F (369)
- Dark Indigo F (288)
- Denim Blue F (266)
- Emerald F (205)
- Erinite F (360)
- Fern Green F (291)
- Fireopal F (237)
- Fuchsia F (502)
- Graphite F (253)
- Greige F (284)
- Hyacinth F (236)
- Indian Pink F (289)
- Indian Siam F (327)
- Iris F (219)
- Jet (280)
- Jet F (280)
- Jonquil F (213)
- Light Amethyst F (212)
- Light Colorado Topaz F (246)
- Light Peach F (362)
- Light Rose F (223)
- Light Sapphire F (211)

Crystal F (001)	■	■	■	■	■	■	■	■	■
Amethyst F (204)	■	■	■	■	■	■	■	■	■
Aquamarine F (202)	■	■	■	■	■	■	■	■	■
Black Diamond F (215)	■	■	■	■	■	■	■	■	■
Blue Zircon F (229)	■	■	■	■	■	■	■	■	■
Blush Rose F (257)	■	■	■	■	■	■	■	■	■
Burgundy F (515)	■	■	■	■	■	■	■	■	■
Capri Blue F (243)	■	■	■	■	■	■	■	■	■
Chrysolite F (238)	■	■	■	■	■	■	■	■	■
Citrine F (249)	■	■	■	■	■	■	■	■	■
Cobalt F (369)	■	■	■	■	■	■	■	■	■
Dark Indigo F (288)	■	■	■	■	■	■	■	■	■
Denim Blue F (266)	■	■	■	■	■	■	■	■	■
Emerald F (205)	■	■	■	■	■	■	■	■	■
Erinite F (360)	■	■	■	■	■	■	■	■	■
Fern Green F (291)	■	■	■	■	■	■	■	■	■
Fireopal F (237)	■	■	■	■	■	■	■	■	■
Fuchsia F (502)	■	■	■	■	■	■	■	■	■
Graphite F (253)	■	■	■	■	■	■	■	■	■
Greige F (284)	■	■	■	■	■	■	■	■	■
Hyacinth F (236)	■	■	■	■	■	■	■	■	■
Indian Pink F (289)	■	■	■	■	■	■	■	■	■
Indian Siam F (327)	■	■	■	■	■	■	■	■	■
Iris F (219)	■	■	■	■	■	■	■	■	■
Jet (280)	■	■	■	■	■	■	■	■	■
Jet F (280)	■	■	■	■	■	■	■	■	■
Jonquil F (213)	■	■	■	■	■	■	■	■	■
Light Amethyst F (212)	■	■	■	■	■	■	■	■	■
Light Colorado Topaz F (246)	■	■	■	■	■	■	■	■	■
Light Peach F (362)	■	■	■	■	■	■	■	■	■
Light Rose F (223)	■	■	■	■	■	■	■	■	■
Light Sapphire F (211)	■	■	■	■	■	■	■	■	■

2088

	Siz	SS 12	SS 14	SS 16	SS 20	SS 24	SS 30	SS 34	SS 40	SS 48
Light Siam F (227)		■		■	■		■	■		
Light Silk F (261)		■		■	■		■	■		
Light Topaz F (226)		■		■	■		■	■		
Light Turquoise F (263)		■		■	■		■	■		
Majestic Blue F (296)		■		■	■		■	■		
Montana F (207)		■		■	■		■	■		
Olivine F (228)		■	■	■	■		■	■		
Padparadscha F (542)		■		■	■		■	■		
Peridot F (214)		■		■	■		■	■		
Provence Lavender F (283)		■		■	■		■	■		
Purple Velvet F (277)		■		■	■		■	■		
Rose F (209)		■		■	■		■	■		
Rose Peach F (262)		■		■	■		■	■		
Ruby F (501)		■		■	■		■	■		
Sapphire F (206)		■		■	■		■	■		
Scarlet F (276)		■	■	■	■		■	■		
Siam F (208)		■		■	■		■	■		
Silk F (391)		■		■	■		■	■		
Smoked Topaz F (220)		■		■	■		■	■		
Sunflower F (292)		■		■	■		■	■		
Tangerine F (259)		■		■	■		■	■		
Tanzanite F (539)		■		■	■		■	■		
Topaz F (203)		■		■	■		■	■		
Vintage Rose F (319)		■		■	■		■	■		
Opal Colors										
Air Blue Opal F (285)		■		■	■		■	■		
Chrysolite Opal F (294)		■		■	■		■	■		
Pacific Opal F (390)		■		■	■		■	■		
White Opal F (234)		■		■	■		■	■		
Yellow Opal F (231)		■		■	■		■	■		
Crystal Effects										
Transparent Effects										
Crystal Antique Pink F (001 ANTP)		■		■	■		■	■		
Crystal AB F (001 AB)		■	■	■	■	■	■	■	■	■
Crystal Blue Shade F (001 BLSH)		■		■	■		■	■		

2088		Siz									
		SS 12	SS 14	SS 16	SS 20	SS 24	SS 30	SS 34	SS 40	SS 48	
	Crystal Copper F (001 COP)	■		■	■		■	■			
	Crystal Golden Shadow F (001 GSHA)	■		■	■		■	■			
	Crystal Luminous Green F (001 LUMG)	■		■	■		■	■			
	Crystal Meridian Blue F (001 MBLUE)	■		■	■		■	■			
	Crystal Moonlight F (001 MOL)	■		■	■		■	■			
	Crystal Paradise Shine F (001 PARSH)	■		■	■		■	■			
	Crystal Shimmer F (001 SHIM)	■		■	■		■	■			
	Crystal Silver Night F (001 SINI)	■		■	■		■	■			
	Crystal Silver Shade F (001 SSHA)	■		■	■		■	■			
	Crystal Volcano F (001 VOL)	■		■	■		■	■			
Metallic Effects											
	Crystal Dorado F (001 DOR)	■		■	■		■	■			
	Crystal Iridescent Green F (001 IRIG)	■		■	■		■	■			
	Crystal Light Chrome F (001 LTCH)	■		■	■		■	■			
	Crystal Metallic Blue F (001 METBL)	■		■	■		■	■			
	Crystal Metallic Light Gold F (001 MLGLD)	■		■	■		■	■			
	Crystal Metallic Sunshine F (001 METSH)	■		■	■		■	■			
	Crystal Rainbow Dark F (001 RABDK)	■		■	■		■	■			
	Crystal Rose Gold F (001 ROGL)	■		■	■		■	■			
	Crystal Scarabaeus Green F (001 SCGR)	■		■	■		■	■			
Crystal Lacquer ^{Pro}											
	Crystal Army Green DeLite (001 L130D)	■		■	■		■	■			
	Crystal Azure Blue (001 L112S)	■		■	■		■	■			
	Crystal Burgundy DeLite (001 L132D)	■		■	■		■	■			
	Crystal Buttercup (001 L124S)	■		■	■		■	■			
	Crystal Cappuccino DeLite (001 L133D)	■		■	■		■	■			
	Crystal Dark Grey (001 L111S)	■		■	■		■	■			
	Crystal Dark Red (001 L108S)	■		■	■		■	■			
	Crystal Elect. Blue DeLite (001 L134D)	■		■	■		■	■			
	Crystal Elect. Green DeLite (001 L135D)	■		■	■		■	■			
	Crystal Elect. Orange DeLite (001 L136D)	■		■	■		■	■			
	Crystal Elect. Pink DeLite (001 L137D)	■		■	■		■	■			
	Crystal Elect. Violet DeLite (001 L148D)	■		■	■		■	■			
	Crystal Elect. White DeLite (001 L139D)	■		■	■		■	■			
	Crystal Elect. Yellow DeLite (001 L138D)	■		■	■		■	■			

2088

	SS 12	SS 14	SS 16	SS 20	SS 24	SS 30	SS 34	SS 40	SS 48
Crystal Electric Blue (001 L134S)	■		■	■		■			
Crystal Electric Green (001 L135S)	■		■	■		■			
Crystal Electric Orange (001 L136S)	■		■	■		■			
Crystal Electric Pink (001 L137S)	■		■	■		■			
Crystal Electric Violet (001 L148S)	■		■	■		■			
Crystal Electric White (001 L139S)	■		■	■		■			
Crystal Electric Yellow (001 L138S)	■		■	■		■			
Crystal Ivory Cream (001 L106S)	■	■	■	■		■			
Crystal Laguna DeLite (001 L142D)	■		■	■		■			
Crystal Lavender DeLite (001 L144D)	■		■	■		■			
Crystal Light Coral (001 L116S)	■	■	■	■		■			
Crystal Light Grey DeLite (001 L129D)	■	■	■	■		■			
Crystal Lilac (001 L126S)	■	■	■	■		■			
Crystal Lime (001 L125S)	■	■	■	■		■	■		
Crystal Lotus Pink DeLite (001 L145D)	■		■	■		■			
Crystal Mint Green (001 L115S)	■	■	■	■		■			
Crystal Ocean DeLite (001 L143D)	■		■	■		■			
Crystal Ochre DeLite (001 L131D)	■	■	■	■		■			
Crystal Orange Glow DeLite (001 L146D)	■		■	■		■			
Crystal Peach DeLite (001 L140D)	■	■	■	■		■			
Crystal Peony Pink (001 L113S)	■	■	■	■		■			
Crystal Royal Blue (001 L110S)	■	■	■	■		■			
Crystal Royal Blue DeLite (001 L110D)	■		■	■		■			
Crystal Royal Green (001 L109S)	■	■	■	■		■			
Crystal Royal Red (001 L107S)	■	■	■	■		■			
Crystal Royal Red DeLite (001 L107D)	■		■	■		■			
Crystal Silky Sage DeLite (001 L147D)	■		■	■		■			
Crystal Summer Blue (001 L114S)	■	■	■	■		■			
Crystal Sunshine DeLite (001 L141D)	■	■	■	■		■			
Color Effects									
Aquamarine AB F (202 AB)	■	■	■	■		■			
Black Diamond Shimmer F (215 SHIM)	■		■	■		■			
Blue Zircon Shimmer F (229 SHIM)	■		■	■		■			
Citrine Shimmer F (249 SHIM)	■	■	■	■		■			
Cobalt Shimmer F (369 SHIM)	■	■	■	■		■			

2088	Siz								
	SS 12	SS 14	SS 16	SS 20	SS 24	SS 30	SS 34	SS 40	SS 48
Erinite Shimmer F (360 SHIM)	■		■	■		■			
Fuchsia Shimmer F (502 SHIM)	■		■	■		■			
Hyacinth Shimmer F (236 SHIM)	■		■	■		■			
Jonquil AB F (213 AB)	■		■	■		■			
Light Colorado Topaz Shimmer F (246 SHIM)	■		■	■		■			
Light Rose AB F (223 AB)	■		■	■		■			
Light Rose Shimmer F (223 SHIM)	■		■	■		■			
Light Sapphire Shimmer F (211 SHIM)	■		■	■		■			
Light Siam AB F (227 AB)	■		■	■		■			
Light Siam Shimmer F (227 SHIM)	■		■	■		■			
Light Topaz Shimmer F (226 SHIM)	■		■	■		■			
Peridot AB F (214 AB)	■		■	■		■			
Peridot Shimmer F (214 SHIM)	■		■	■		■			
Rose AB F (209 AB)	■		■	■		■			
Rose Peach Shimmer F (262 SHIM)	■		■	■		■			
Sapphire AB F (206 AB)	■		■	■		■			
Siam Shimmer F (208 SHIM)	■		■	■		■			
Silk Shimmer F (391 SHIM)	■		■	■		■			
Tangerine Shimmer F (259 SHIM)	■	■	■	■		■			
Tanzanite Shimmer F (539 SHIM)	■		■	■		■			
Topaz AB F (203 AB)	■		■	■		■			
Topaz Shimmer F (203 SHIM)	■		■	■		■			
Jet Hematite (280 HEM)	■		■	■		■		■	
Jet Hematite F (280 HEM)	■		■	■		■		■	

2088/I RhmedXIRIUS Rose

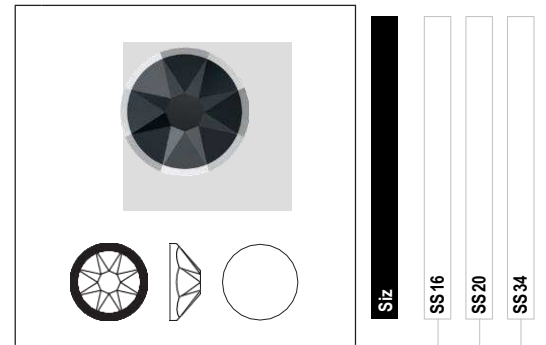

Crystal Effects

Metallic Effects

	SS 16	SS 20	SS 34
Crystal Dorado Z F (001 DORZ)	■	■	■
Crystal Light Chrome Z F (001 LTCHZ)	■	■	■
Color Effects			
Black Diamond Dorado Z F (215 DORZ)	■	■	■
Black Diamond Light Chrome Z F (215 LTCHZ)	■	■	■
Burgundy Dorado Z F (515 DORZ)	■	■	■
Burgundy Light Chrome Z F (515 LTCHZ)	■	■	■
Denim Blue Dorado Z F (266 DORZ)	■	■	■
Denim Blue Light Chrome Z F (266 LTCHZ)	■	■	■
Greige Dorado Z F (284 DORZ)	■	■	■
Greige Light Chrome Z F (284 LTCHZ)	■	■	■
Jet Dorado Z (280 DORZ)	■	■	■
Jet Light Chrome Z (280 LTCHZ)	■	■	■
Khaki Dorado Z F (550 DORZ)	■	■	■
Khaki Light Chrome Z F (550 LTCHZ)	■	■	■
Light Siam Dorado Z F (227 DORZ)	■	■	■
Light Siam Light Chrome Z F (227 LTCHZ)	■	■	■
White Opal Dorado Z F (234 DORZ)	■	■	■
White Opal Light Chrome Z F (234 LTCHZ)	■	■	■

CORE ASSORTMENT

2200 Navette Flat Back



Siz

MM 4,0X 2,0

MM 8,0X 4,0

- Crystal**
- Crystal F (001) ■ ■
- Colors**
- Plain Colors**
- Amethyst F (204) ■ ■
- Aquamarine F (202) ■ ■
- Emerald F (205) ■ ■
- Jet (280) ■ ■
- Light Colorado Topaz F (246) ■ ■
- Light Rose F (223) ■ ■
- Scarlet F (276) ■ ■
- Crystal Effects**
- Transparent Effects**
- Crystal AB F (001 AB) ■ ■
- Crystal Golden Shadow F (001 GSHA) ■ ■

2201 Marquise Flat Back

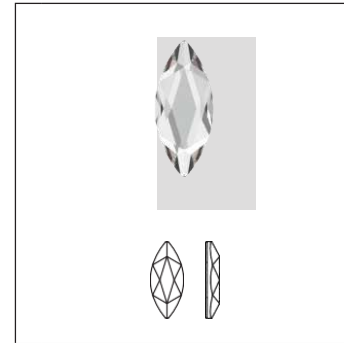

Siz

MM 8,0X 3,5

MM 14,0X 6,0

- Crystal**
- Crystal F (001) ■ ■
- Colors**
- Plain Colors**
- Aquamarine F (202) ■ ■
- Emerald F (205) ■ ■
- Graphite F (253) ■ ■
- Jet (280) ■ ■
- Sapphire F (206) ■ ■
- Scarlet F (276) ■ ■
- Sunflower F (292) ■ ■
- Vintage Rose F (319) ■ ■
- Crystal Effects**
- Transparent Effects**
- Crystal AB F (001 AB) ■ ■
- Crystal Golden Shadow F (001 GSHA) ■ ■
- Crystal Silver Shade F (001 SSHA) ■ ■
- Color Effects**
- Aquamarine Shimmer F (202 SHIM) ■ ■
- Scarlet Shimmer F (276 SHIM) ■ ■
- Vintage Rose Shimmer F (319 SHIM) ■ ■

2204 Pure Leaf Flat Back

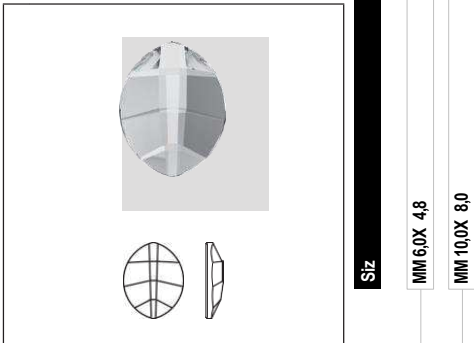

Siz

MM 6,0X 4,8

MM 10,0X 8,0

- Crystal**
- Crystal F (001) ■ ■
- Crystal Effects**
- Transparent Effects**
- Crystal AB F (001 AB) ■ ■

2205 Flame FlatBack



Siz	MM 7,5	MM 10,0	MM 14,0
-----	--------	---------	---------

Crystal			
Crystal F (001)	■	■	■
Colors			
Plain Colors			
Fireopal F (237)	■	■	■
Jet (280)	■	■	■
Light Colorado Topaz F (246)	■	■	■
Light Siam F (227)	■	■	■
Opal Colors			
White Opal F (234)	■	■	■
Crystal Effects			
Transparent Effects			
Crystal AB F (001 AB)	■	■	■
Crystal Golden Shadow F (001 GSHA)	■	■	■
Crystal Silver Night (001 SINI)	■	■	■
Metallic Effects			
Crystal Iridescent Green F (001 IRIG)	■	■	■

CORE ASSORTMENT

2300 Drop FlatBack

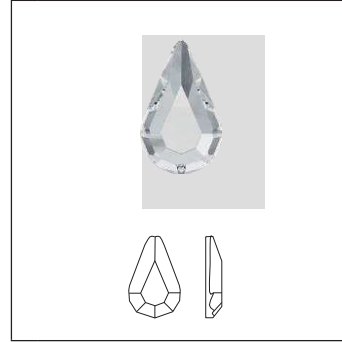

Siz	MM 8,0X 4,8	MM 10,0X 6,0
-----	-------------	--------------

Crystal		
Crystal F (001)	■	■
Colors		
Plain Colors		
Amethyst F (204)	■	■
Aquamarine F (202)	■	■
Emerald F (205)	■	■
Jet (280)	■	■
Light Colorado Topaz F (246)	■	■
Light Rose F (223)	■	■
Scarlet F (276)	■	■

2303 PearFlatBack

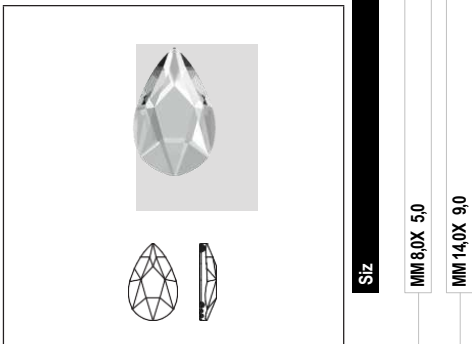

Crystal		MM 8,0X 5,0	MM 14,0X 9,0
Crystal F (001)		■	■
Colors			
Plain Colors			
Aquamarine F (202)		■	■
Emerald F (205)		■	■
Graphite F (253)		■	■
Jet (280)		■	■
Sapphire F (206)		■	■
Scarlet F (276)		■	■
Sunflower F (292)		■	■
Vintage Rose F (319)		■	■
Crystal Effects			
Transparent Effects			
Crystal AB F (001 AB)		■	■
Crystal Golden Shadow F (001 GSHA)		■	■
Crystal Silver Shade F (001 SSHA)		■	■
Color Effects			
Aquamarine Shimmer F (202 SHIM)		■	■
Light Siam Shimmer F (227 SHIM)		■	■
Scarlet Shimmer F (276 SHIM)		■	■
Silk Shimmer F (391 SHIM)		■	■
Vintage Rose Shimmer F (319 SHIM)		■	■

2304 Raindrop FlatBack



Crystal		MM 6,0X 1,7	MM 10,0X 2,8	MM 14,0X 3,9
Crystal F (001)		■	■	■
Colors				
Plain Colors				
Blush Rose F (257)		■	■	■
Jet (280)		■	■	■
Light Siam F (227)		■	■	■
Crystal Effects				
Transparent Effects				
Crystal AB F (001 AB)		■	■	■
Crystal Blue Shade F (001 BLSH)		■	■	■
Crystal Golden Shadow F (001 GSHA)		■	■	■
Crystal Luminous Green F (001 LUMG)		■	■	■
Crystal Silver Night (001 SINI)		■	■	■

2364 PASLEYXFLATBACK



Siz	MM 6,0X 3,7	MM 10,0X 6,0	MM 14,0X 8,5
Crystal			
Crystal F (001)	■	■	■
Colors			
Plain Colors			
Jet (280)	■		
Light Colorado Topaz F (246)	■		
Majestic Blue F (296)	■	■	■
Scarlet F (276)	■	■	■
Crystal Effects			
Transparent Effects			
Crystal AB F (001 AB)	■	■	■
Crystal Golden Shadow F (001 GSHA)	■	■	■
Crystal Silver Night (001 SINI)	■	■	■
Crystal Silver Shade F (001 SSHA)	■	■	■

Crystal

Crystal F (001)

Colors

Plain Colors

Jet (280)

Light Colorado Topaz F (246)

Majestic Blue F (296)

Scarlet F (276)

Crystal Effects

Transparent Effects

Crystal AB F (001 AB)

Crystal Golden Shadow F (001 GSHA)

Crystal Silver Night (001 SINI)

Crystal Silver Shade F (001 SSHA)

2365 PAISLEYFLATBACK

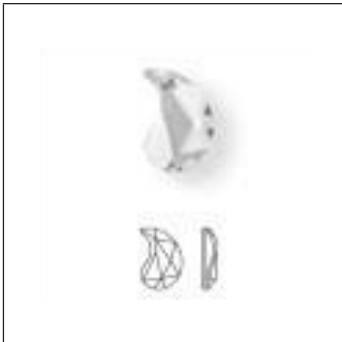

Siz	MM 6,0X 3,7	MM 10,0X 6,0	MM 14,0X 8,5
-----	-------------	--------------	--------------

Crystal

Crystal F (001)	■	■	■
-----------------	---	---	---

Colors

Plain Colors

Jet (280)	■		
Light Colorado Topaz F (246)	■		
Majestic Blue F (296)	■	■	■
Scarlet F (276)	■	■	■

Crystal Effects

Transparent Effects

Crystal AB F (001 AB)	■	■	■
Crystal Golden Shadow F (001 GSHA)	■	■	■
Crystal Silver Night (001 SINI)	■	■	■
Crystal Silver Shade F (001 SSHA)	■	■	■

SQUARE FAMILY

CORE ASSORTMENT

2400 Square Flat Back

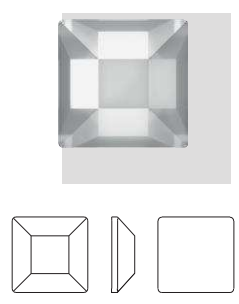

	Siz	MM 2.2	MM 3.0	MM 4.0	MM 6.0	MM 10.0
Crystal						
Crystal F (001)		■	■	■	■	■
Colors						
Plain Colors						
Amethyst F (204)		■	■	■	■	
Aquamarine F (202)		■	■	■	■	
Emerald F (205)			■	■	■	
Jet (280)		■	■	■	■	■
Light Colorado Topaz F (246)		■	■	■	■	
Light Rose F (223)			■	■	■	
Scarlet F (276)			■	■	■	
Crystal Effects						
Transparent Effects						
Crystal AB F (001 AB)		■	■	■	■	
Crystal Golden Shadow F (001 GSHA)		■	■	■	■	
Crystal Silver Night (001 SINI)			■	■	■	
Metallic Effects						
Crystal Dorado F (001 DOR)				■	■	
Crystal Light Chrome F (001 LTCH)			■	■	■	
Color Effects						
Jet Hematite (280 HEM)				■	■	
Jet Hematite F (280 HEM)			■			

2402 Base Flat Back

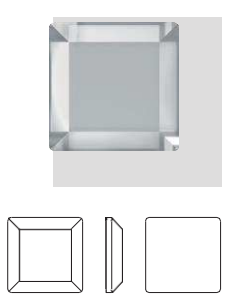

	Siz	MM 4.0	MM 6.0	MM 10.0
Crystal				
Crystal F (001)		■	■	■
Colors				
Plain Colors				
Jet (280)		■	■	■
Crystal Effects				
Transparent Effects				
Crystal AB F (001 AB)		■	■	
Crystal Golden Shadow F (001 GSHA)		■	■	
Crystal Silver Night (001 SINI)		■	■	
Metallic Effects				
Crystal Dorado F (001 DOR)		■	■	
Crystal Light Chrome F (001 LTCH)		■	■	
Color Effects				
Jet Hematite (280 HEM)		■	■	

2403 Pyramid FlatBack

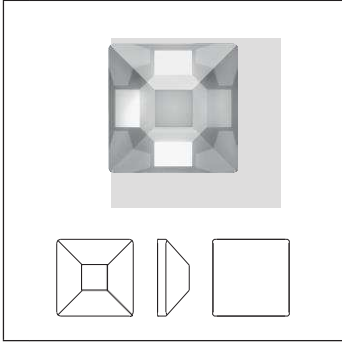

Siz	MM 4,0	MM 6,0	MM 10,0
-----	--------	--------	---------

Crystal

Crystal F (001)	■	■	■
-----------------	---	---	---

Colors

Plain Colors

Jet (280)	■	■	■
-----------	---	---	---

Crystal Effects

Transparent Effects

Crystal AB F (001 AB)	■	■	
-----------------------	---	---	--

Crystal Golden Shadow F (001 GSHA)	■	■	
------------------------------------	---	---	--

Crystal Silver Night (001 SINI)	■	■	
---------------------------------	---	---	--

Metallic Effects

Crystal Dorado F (001 DOR)	■	■	
----------------------------	---	---	--

Crystal Light Chrome F (001 LTCH)	■	■	
-----------------------------------	---	---	--

Color Effects

Jet Hematite (280 HEM)	■	■	
------------------------	---	---	--

SQUAR FAMILY

2419 SQUARE SPIKEFLAT BACK

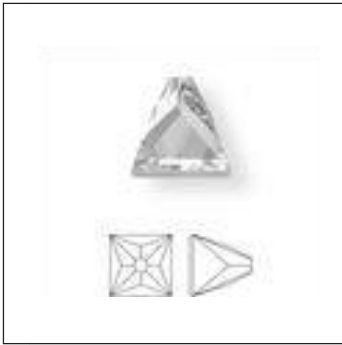

Siz	MM 4,0X 4,0	MM 5,0X 5,0	MM 6,0X 6,0
Crystal			
Crystal F (001)	■	■	■
Crystal Effects			
Transparent Effects			
Crystal AB F (001 AB)	■	■	■
Crystal Blue Shade F (001 BLSH)	■	■	■
Crystal Golden Shadow F (001 GSHA)	■	■	■
Crystal Volcano F (001 VOL)	■	■	■
Color Effects			
Black Diamond Shimmer F (215 SHIM)	■	■	■
Light Topaz Shimmer F (226 SHIM)	■	■	■

Crystal

Crystal F (001)

Crystal Effects

Transparent Effects

Crystal AB F (001 AB)

Crystal Blue Shade F (001 BLSH)

Crystal Golden Shadow F (001 GSHA)

Crystal Volcano F (001 VOL)

Color Effects

Black Diamond Shimmer F (215 SHIM)

Light Topaz Shimmer F (226 SHIM)

2471 CUSHION FLATBACK



Size	MM		
	5,0	7,0	10,0
Crystal			
Crystal F (001)	■	■	■
Colors			
Plain Colors			
Aquamarine F (202)	■	■	■
Emerald F (205)	■	■	■
Graphite F (253)	■	■	■
Jet (280)	■	■	■
Sapphire F (206)	■	■	■
Scarlet F (276)	■	■	■
Sunflower F (292)	■	■	■
Vintage Rose F (319)	■	■	■
Crystal Effects			
Transparent Effects			
Crystal AB F (001 AB)	■	■	■
Crystal Golden Shadow F (001 GSHA)	■	■	■
Crystal Silver Shade F (001 SSHA)	■	■	■
Color Effects			
Aquamarine Shimmer F (202 SHIM)	■	■	■
Scarlet Shimmer F (276 SHIM)	■	■	■
Vintage Rose Shimmer F (319 SHIM)	■	■	■

SQUARE FAMILY

2420 Asymmetric Square Flat Back

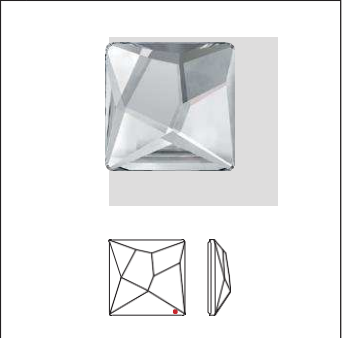

Siz

MM 10,0

MM 25,0

Crystal

- Crystal F (001)

Crystal Effects

Metallic Effects

- Crystal CAL V SI (001 CAVSI)

2483 Classic Square Flat Back

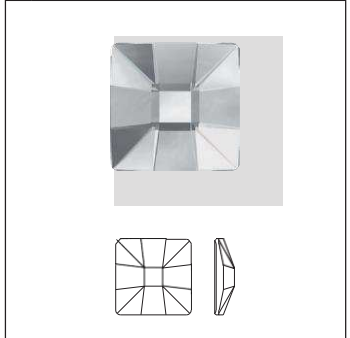

Siz

MM 10,0

MM 25,0

Crystal

- Crystal F (001)

Crystal Effects

Metallic Effects

- Crystal CAL SI (001 CASI)
- Crystal CAL V SI (001 CAVSI)

2493 Chessboard Flat Back

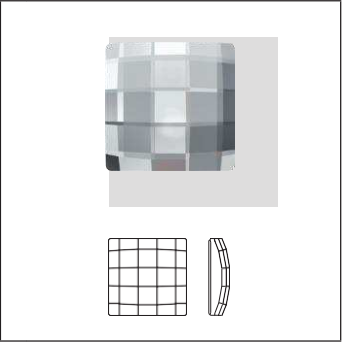

Siz

MM 8,0

MM 10,0

MM 20,0

Crystal

- Crystal F (001)

Colors

Plain Colors

- Black Diamond F (215)
- Jet F (280)

Crystal Effects

Transparent Effects

- Crystal AB F (001 AB)
- Crystal Golden Shadow F (001 GSHA)

2494 Starlet Flat Back



Siz

MM 6,0

MM 8,0

Crystal

- Crystal F (001)

Crystal Effects

Transparent Effects

- Crystal AB F (001 AB)
- Crystal Golden Shadow F (001 GSHA)

¹ Coated on faceted side.

2510 Asymmetric Square Flat Back¹



Siz

MM 3,7X 1,9

Crystal

Crystal F (001)

Colors

Plain Colors

Jet (280)

Crystal Effects

Transparent Effects

Crystal AB F (001 AB)

Crystal Golden Shadow F (001 GSHA)

¹ Coated on faceted side.

2520 CosmicFlatBack

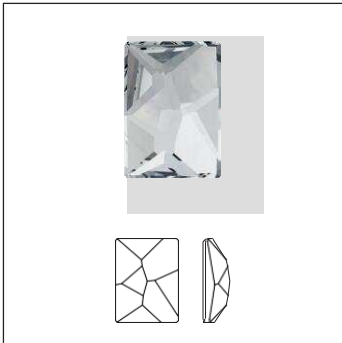

Siz	MM 8,0X 6,0	MM 10,0X 8,0	MM 14,0X 10,0
Crystal			
Crystal F (001)	■	■	■
Colors			
Plain Colors			
Jet (280)	■	■	■
Crystal Effects			
Transparent Effects			
Crystal AB F (001 AB)	■	■	■
Crystal Golden Shadow F (001 GSHA)	■	■	■

- Crystal
- Crystal F (001)
- Colors
- Plain Colors
- Jet (280)
- Crystal Effects
- Transparent Effects
- Crystal AB F (001 AB)
- Crystal Golden Shadow F (001 GSHA)

2540 CurvyFlatBack

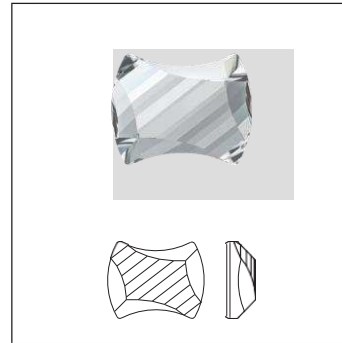

Siz	MM 7,0X 5,5
Crystal	
Crystal F (001)	■
Crystal Effects	
Transparent Effects	
Crystal AB F (001 AB)	■
Crystal Paradise Shine F (001 PARSH)	■

- Crystal
- Crystal F (001)
- Crystal Effects
- Transparent Effects
- Crystal AB F (001 AB)
- Crystal Paradise Shine F (001 PARSH)

2555 CosmicBaguetteFlatBack

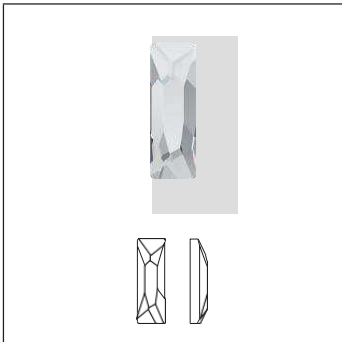

Siz	MM 8,0X 2,6	MM 12,0X 4,0	MM 15,0X 5,0
Crystal			
Crystal F (001)	■	■	■
Colors			
Plain Colors			
Jet (280)	■	■	■
Crystal Effects			
Transparent Effects			
Crystal Golden Shadow F (001 GSHA)	■	■	■

- Crystal
- Crystal F (001)
- Colors
- Plain Colors
- Jet (280)
- Crystal Effects
- Transparent Effects
- Crystal Golden Shadow F (001 GSHA)

2570 VigourRectangleFlat Back¹

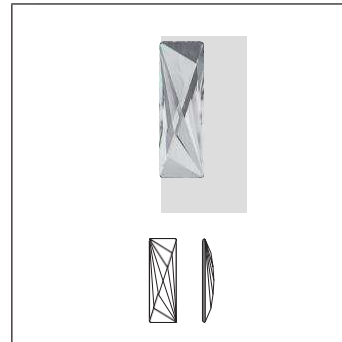

Siz	MM 50,0X 16,0
Crystal	
Crystal F (001)	■
Crystal Effects	
Metallic Effects	
Crystal CAL SI (001 CASI)	■
Crystal CAL V SI (001 CAVSI)	■

- Crystal
- Crystal F (001)
- Crystal Effects
- Metallic Effects
- Crystal CAL SI (001 CASI)
- Crystal CAL V SI (001 CAVSI)

¹ Coated on faceted side.

2585 Graphic FlatBack

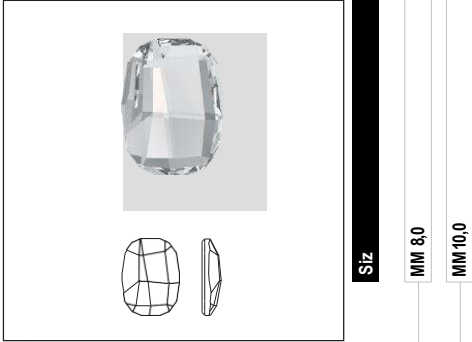

Siz

MM 8,0

MM 10,0

Crystal

Crystal F (001)

Crystal Effects

Transparent Effects

Crystal AB F (001 AB)

2602 Emerald Cut Flat Back

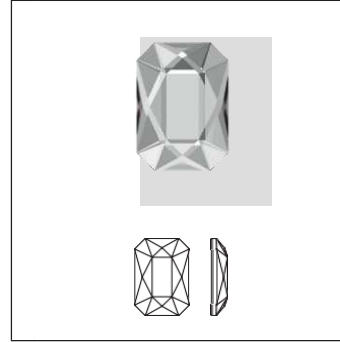

Siz

MM 8,0X 5,5

MM 14,0X 10,0

Crystal

Crystal F (001)

Colors

Plain Colors

Aquamarine F (202)

Emerald F (205)

Graphite F (253)

Jet (280)

Sapphire F (206)

Scarlet F (276)

Sunflower F (292)

Vintage Rose F (319)

Crystal Effects

Transparent Effects

Crystal AB F (001 AB)

Crystal Golden Shadow F (001 GSHA)

Crystal Silver Shade F (001 SSHA)

Color Effects

Aquamarine Shimmer F (202 SHIM)

Fuchsia Shimmer F (502 SHIM)

Light Sapphire Shimmer F (211 SHIM)

Light Siam Shimmer F (227 SHIM)

Light Topaz Shimmer F (226 SHIM)

Scarlet Shimmer F (276 SHIM)

Silk Shimmer F (391 SHIM)

Vintage Rose Shimmer F (319 SHIM)

2709 Rhombus Flat Back

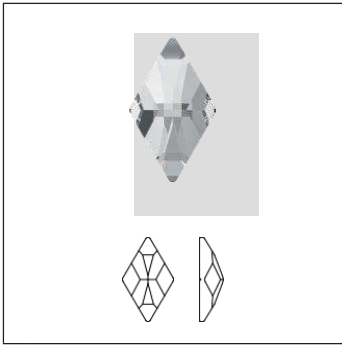

Siz
MM 10.0X 6.0
MM 13.0X 8.0

- Crystal**
- Crystal F (001)
- Colors**
- Plain Colors**
- Aquamarine F (202)
- Black Diamond F (215)
- Light Rose F (223)
- Light Siam F (227)
- Crystal Effects**
- Transparent Effects**
- Crystal AB F (001 AB)
- Crystal Golden Shadow F (001 GSHA)
- Crystal Silver Shade F (001 SSHA)

2711 Triangle Flat Back

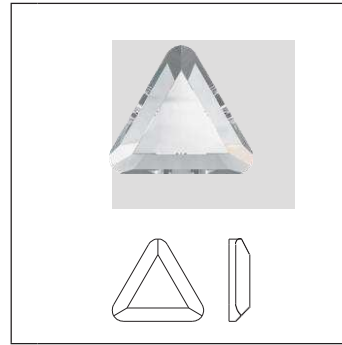

Siz
MM 3.3

- Crystal**
- Crystal F (001)
- Colors**
- Plain Colors**
- Amethyst F (204)
- Aquamarine F (202)
- Emerald F (205)
- Jet (280)
- Light Colorado Topaz F (246)
- Crystal Effects**
- Transparent Effects**
- Crystal AB F (001 AB)
- Crystal Golden Shadow F (001 GSHA)

2714 FanFlatBack

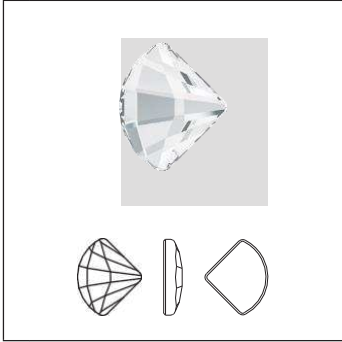

Siz

MM 6,0

MM 10,0

- Crystal**
- Crystal F (001)
- Crystal Effects**
- Transparent Effects**
- Crystal AB F (001 AB)

2716 Rivoli Triangle Flat Back

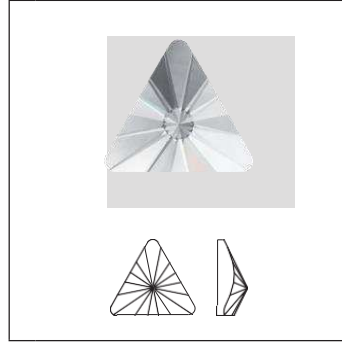

Siz

MM 5,0

- Crystal**
- Crystal F (001)
- Crystal Effects**
- Transparent Effects**
- Crystal AB F (001 AB)

2720 CosmicDeltaFlat Back

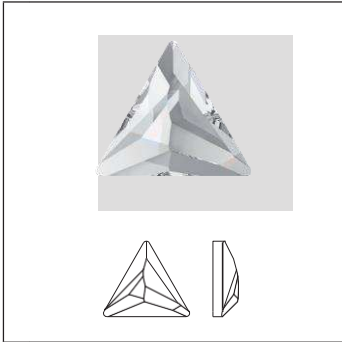

Siz

MM 7,5

MM 9,0

MM 12,5

- Crystal**
- Crystal F (001)

TRIANGLE FAMILY

2738 Triangle Alpha Flat Back

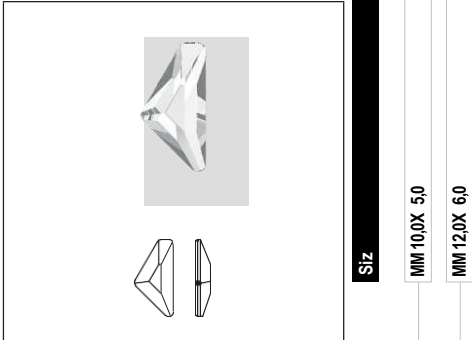

Siz

MM 10,0X 5,0

MM 12,0X 6,0

Crystal		
<input type="checkbox"/>	Crystal F (001)	<input type="checkbox"/>
Colors		
Plain Colors		
<input type="checkbox"/>	Blush Rose F (257)	<input type="checkbox"/>
<input type="checkbox"/>	Jet (280)	<input type="checkbox"/>
<input type="checkbox"/>	Light Colorado Topaz F (246)	<input type="checkbox"/>
<input type="checkbox"/>	Light Sapphire F (211)	<input type="checkbox"/>
<input type="checkbox"/>	Light Siam F (227)	<input type="checkbox"/>
Crystal Effects		
Transparent Effects		
<input type="checkbox"/>	Crystal AB F (001 AB)	<input type="checkbox"/>
<input type="checkbox"/>	Crystal Golden Shadow F (001 GSHA)	<input type="checkbox"/>
<input type="checkbox"/>	Crystal Silver Night (001 SINI)	<input type="checkbox"/>
Crystal Lacquer ^{Pro}		
<input type="checkbox"/>	Crystal Dark Grey (001 L111S)	<input type="checkbox"/>
<input type="checkbox"/>	Crystal Dark Red (001 L108S)	<input type="checkbox"/>
<input type="checkbox"/>	Crystal Ivory Cream (001 L106S)	<input type="checkbox"/>
Color Effects		
<input type="checkbox"/>	Light Colorado Topaz Shimmer F (246 SHIM)	<input type="checkbox"/>
<input type="checkbox"/>	Light Sapphire Shimmer F (211 SHIM)	<input type="checkbox"/>
<input type="checkbox"/>	Light Siam Shimmer F (227 SHIM)	<input type="checkbox"/>

2739 Triangle Beta Flat Back

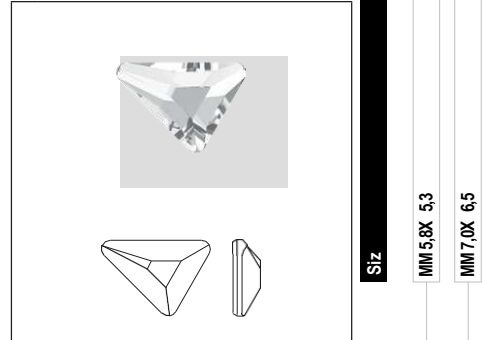

Siz

MM 5,8X 5,3

MM 7,0X 6,5

Crystal		
<input type="checkbox"/>	Crystal F (001)	<input type="checkbox"/>
Colors		
Plain Colors		
<input type="checkbox"/>	Blush Rose F (257)	<input type="checkbox"/>
<input type="checkbox"/>	Jet (280)	<input type="checkbox"/>
<input type="checkbox"/>	Light Colorado Topaz F (246)	<input type="checkbox"/>
<input type="checkbox"/>	Light Sapphire F (211)	<input type="checkbox"/>
<input type="checkbox"/>	Light Siam F (227)	<input type="checkbox"/>
Crystal Effects		
Transparent Effects		
<input type="checkbox"/>	Crystal AB F (001 AB)	<input type="checkbox"/>
<input type="checkbox"/>	Crystal Golden Shadow F (001 GSHA)	<input type="checkbox"/>
<input type="checkbox"/>	Crystal Silver Night (001 SINI)	<input type="checkbox"/>
Crystal Lacquer ^{Pro}		
<input type="checkbox"/>	Crystal Dark Grey (001 L111S)	<input type="checkbox"/>
<input type="checkbox"/>	Crystal Dark Red (001 L108S)	<input type="checkbox"/>
<input type="checkbox"/>	Crystal Ivory Cream (001 L106S)	<input type="checkbox"/>
Color Effects		
<input type="checkbox"/>	Light Colorado Topaz Shimmer F (246 SHIM)	<input type="checkbox"/>
<input type="checkbox"/>	Light Sapphire Shimmer F (211 SHIM)	<input type="checkbox"/>
<input type="checkbox"/>	Light Siam Shimmer F (227 SHIM)	<input type="checkbox"/>

TRIANGLE FAMILY

2740 Triangle Gamma Flat Back

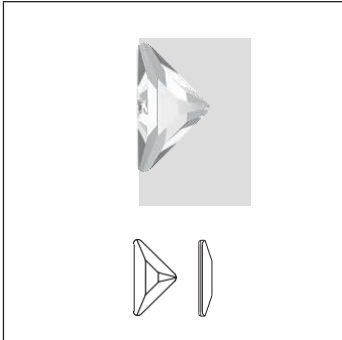

Size	MM 8,3X 8,3	MM 10,0X 10,0

Crystal		
<input type="checkbox"/>	Crystal F (001)	<input type="checkbox"/>
Colors		
Plain Colors		
<input type="checkbox"/>	Blush Rose F (257)	<input type="checkbox"/>
<input type="checkbox"/>	Jet (280)	<input type="checkbox"/>
<input type="checkbox"/>	Light Colorado Topaz F (246)	<input type="checkbox"/>
<input type="checkbox"/>	Light Sapphire F (211)	<input type="checkbox"/>
<input type="checkbox"/>	Light Siam F (227)	<input type="checkbox"/>
Crystal Effects		
Transparent Effects		
<input type="checkbox"/>	Crystal AB F (001 AB)	<input type="checkbox"/>
<input type="checkbox"/>	Crystal Golden Shadow F (001 GSHA)	<input type="checkbox"/>
<input type="checkbox"/>	Crystal Silver Night (001 SINI)	<input type="checkbox"/>
Crystal Lacquer <sup>Pro</sup>		
<input type="checkbox"/>	Crystal Dark Grey (001 L111S)	<input type="checkbox"/>
<input type="checkbox"/>	Crystal Dark Red (001 L108S)	<input type="checkbox"/>
<input type="checkbox"/>	Crystal Ivory Cream (001 L106S)	<input type="checkbox"/>
Color Effects		
<input type="checkbox"/>	Light Colorado Topaz Shimmer F (246 SHIM)	<input type="checkbox"/>
<input type="checkbox"/>	Light Sapphire Shimmer F (211 SHIM)	<input type="checkbox"/>
<input type="checkbox"/>	Light Siam Shimmer F (227 SHIM)	<input type="checkbox"/>

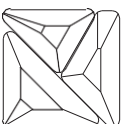

When Alpha, Beta, and Gamma Flat Backs are arranged together, they form a square.

2753 Edelweiss Flat Back

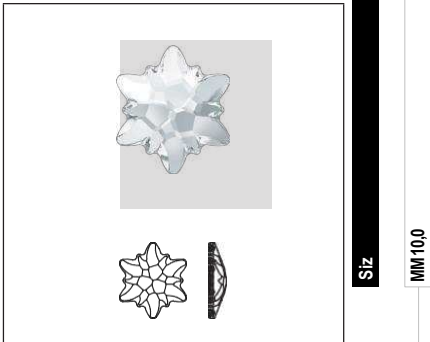

Siz

MM10,0

Crystal

Crystal F (001)

Colors

Plain Colors

Vintage Rose F (319)

Crystal Effects

Transparent Effects

Crystal AB F (001 AB)

Crystal Golden Shadow F (001 GSHA)

Crystal Silver Night (001 SINI)

2770 Wing Flat Back

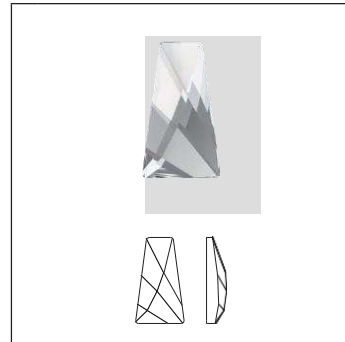

Siz

MM 6,0X 3,5

MM 12,0X 7,0

Crystal

Crystal F (001)

Colors

Plain Colors

Black Diamond F (215)

Crystal Effects

Transparent Effects

Crystal Golden Shadow F (001 GSHA)

Crystal Silver Shade F (001 SSHA)

GEOMETRIC FLAT BACKS

2771 Kite Flat Back

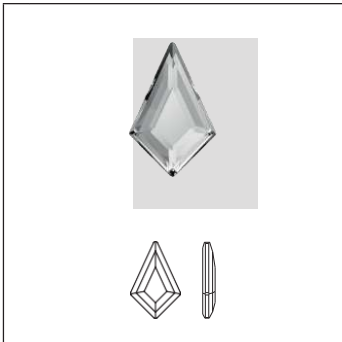

Siz	MM 6,4X 4,2	MM 8,6X 5,6	MM 12,9X 8,3
-----	-------------	-------------	--------------

Crystal	MM 6,4X 4,2	MM 8,6X 5,6	MM 12,9X 8,3
Crystal F (001)	■	■	■
Colors			
Plain Colors			
Aquamarine F (202)	■	■	■
Black Diamond F (215)	■	■	■
Jet (280)	■	■	■
Light Rose F (223)	■	■	■
Light Siam F (227)	■	■	■
Crystal Effects			
Transparent Effects			
Crystal AB F (001 AB)	■	■	■
Crystal Golden Shadow F (001 GSHA)	■	■	■
Crystal Silver Shade F (001 SSHA)	■	■	■
Color Effects			
Metallic Effects			
Jet Hematite (280 HEM)	■	■	■

2772 Trapeze Flat Back

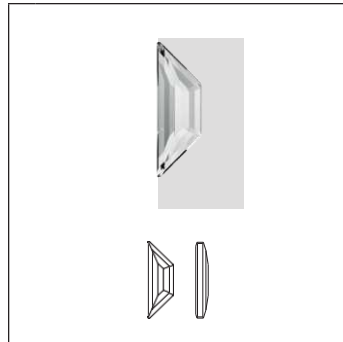

Siz	MM 6,5X 2,1	MM 8,6X 2,8	MM 12,9X 4,2
-----	-------------	-------------	--------------

Crystal	MM 6,5X 2,1	MM 8,6X 2,8	MM 12,9X 4,2
Crystal F (001)	■	■	■
Colors			
Plain Colors			
Aquamarine F (202)	■	■	■
Black Diamond F (215)	■	■	■
Jet (280)	■	■	■
Crystal Effects			
Transparent Effects			
Crystal AB F (001 AB)	■	■	■
Crystal Golden Shadow F (001 GSHA)	■	■	■
Crystal Silver Shade F (001 SSHA)	■	■	■
Color Effects			
Metallic Effects			
Jet Hematite (280 HEM)	■	■	■

2773 Diamond Shape Flat Back

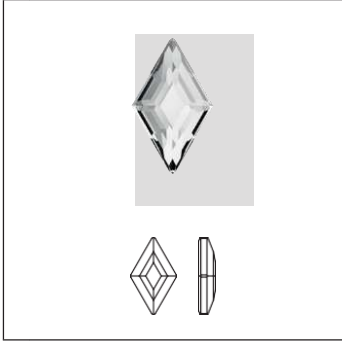

Siz	MM 5,0X 3,0	MM 6,6X 3,9	MM 9,9X 5,9
-----	-------------	-------------	-------------

Crystal

<input type="checkbox"/>	Crystal F (001)	<input checked="" type="checkbox"/>	<input checked="" type="checkbox"/>	<input checked="" type="checkbox"/>
--------------------------	-----------------	-------------------------------------	-------------------------------------	-------------------------------------

Colors

Plain Colors

<input type="checkbox"/>	Aquamarine F (202)	<input checked="" type="checkbox"/>	<input checked="" type="checkbox"/>	<input checked="" type="checkbox"/>
--------------------------	--------------------	-------------------------------------	-------------------------------------	-------------------------------------

<input type="checkbox"/>	Black Diamond F (215)	<input checked="" type="checkbox"/>	<input checked="" type="checkbox"/>	<input checked="" type="checkbox"/>
--------------------------	-----------------------	-------------------------------------	-------------------------------------	-------------------------------------

<input type="checkbox"/>	Jet (280)	<input checked="" type="checkbox"/>	<input checked="" type="checkbox"/>	<input checked="" type="checkbox"/>
--------------------------	-----------	-------------------------------------	-------------------------------------	-------------------------------------

<input type="checkbox"/>	Light Rose F (223)	<input checked="" type="checkbox"/>	<input checked="" type="checkbox"/>	<input checked="" type="checkbox"/>
--------------------------	--------------------	-------------------------------------	-------------------------------------	-------------------------------------

<input type="checkbox"/>	Light Siam F (227)	<input checked="" type="checkbox"/>	<input checked="" type="checkbox"/>	<input checked="" type="checkbox"/>
--------------------------	--------------------	-------------------------------------	-------------------------------------	-------------------------------------

Crystal Effects

Transparent Effects

<input type="checkbox"/>	Crystal AB F (001 AB)	<input checked="" type="checkbox"/>	<input checked="" type="checkbox"/>	<input checked="" type="checkbox"/>
--------------------------	-----------------------	-------------------------------------	-------------------------------------	-------------------------------------

<input type="checkbox"/>	Crystal Golden Shadow F (001 GSHA)	<input checked="" type="checkbox"/>	<input checked="" type="checkbox"/>	<input checked="" type="checkbox"/>
--------------------------	------------------------------------	-------------------------------------	-------------------------------------	-------------------------------------

<input type="checkbox"/>	Crystal Silver Shade F (001 SSHA)	<input checked="" type="checkbox"/>	<input checked="" type="checkbox"/>	<input checked="" type="checkbox"/>
--------------------------	-----------------------------------	-------------------------------------	-------------------------------------	-------------------------------------

Color Effects

Metallic Effects

<input type="checkbox"/>	Jet Hematite (280 HEM)	<input checked="" type="checkbox"/>	<input checked="" type="checkbox"/>	<input checked="" type="checkbox"/>
--------------------------	------------------------	-------------------------------------	-------------------------------------	-------------------------------------

GEO MET RIC FLAT BACK S & DE SIGNE REDITION

2774 ELONGATED PENTAGON FB



Siz

MM 6,3X 4,2
MM 8,3X 5,6
MM 12,5X 8,4

Crystal

<input type="checkbox"/> Crystal F (001)	<input checked="" type="checkbox"/>	<input checked="" type="checkbox"/>	<input checked="" type="checkbox"/>
--	-------------------------------------	-------------------------------------	-------------------------------------

Colors

Plain Colors

<input type="checkbox"/> Aquamarine F (202)	<input checked="" type="checkbox"/>	<input checked="" type="checkbox"/>	<input type="checkbox"/>
---	-------------------------------------	-------------------------------------	--------------------------

<input type="checkbox"/> Black Diamond F (215)	<input checked="" type="checkbox"/>	<input checked="" type="checkbox"/>	<input checked="" type="checkbox"/>
--	-------------------------------------	-------------------------------------	-------------------------------------

<input type="checkbox"/> Jet (280)	<input checked="" type="checkbox"/>	<input checked="" type="checkbox"/>	<input type="checkbox"/>
------------------------------------	-------------------------------------	-------------------------------------	--------------------------

<input type="checkbox"/> Light Siam F (227)	<input checked="" type="checkbox"/>	<input checked="" type="checkbox"/>	<input checked="" type="checkbox"/>
---	-------------------------------------	-------------------------------------	-------------------------------------

Crystal Effects

Transparent Effects

<input type="checkbox"/> Crystal AB F (001 AB)	<input checked="" type="checkbox"/>	<input checked="" type="checkbox"/>	<input checked="" type="checkbox"/>
--	-------------------------------------	-------------------------------------	-------------------------------------

<input type="checkbox"/> Crystal Silver Shade F (001 SSHA)	<input checked="" type="checkbox"/>	<input checked="" type="checkbox"/>	<input type="checkbox"/>
--	-------------------------------------	-------------------------------------	--------------------------

Color Effects

Metallic Effects

<input type="checkbox"/> Jet Hematite (280 HEM)	<input checked="" type="checkbox"/>	<input checked="" type="checkbox"/>	<input checked="" type="checkbox"/>
---	-------------------------------------	-------------------------------------	-------------------------------------

2775 CONCISE PENTAGON FB



Siz	MM 5,0X 4,2	MM 6,7X 5,6	MM 10,0X 8,4
-----	-------------	-------------	--------------

Crystal

Crystal F (001)	■	■	■
-----------------	---	---	---

Colors

Plain Colors

Aquamarine F (202)	■	■	
--------------------	---	---	--

Black Diamond F (215)	■	■	■
-----------------------	---	---	---

Jet (280)	■	■	
-----------	---	---	--

Light Siam F (227)	■	■	■
--------------------	---	---	---

Crystal Effects

Transparent Effects

Crystal AB F (001 AB)	■	■	■
-----------------------	---	---	---

Crystal Silver Shade F (001 SSHA)	■	■	
-----------------------------------	---	---	--

Color Effects

Metallic Effects

Jet Hematite (280 HEM)	■	■	■
------------------------	---	---	---

2776 ELONGATED HEXAGON FB



Siz	MM 8,2X 4,2	MM 11,0X 5,6	MM 16,5X 8,4
Crystal			
Crystal F (001)	■	■	■
Colors			
Plain Colors			
Aquamarine F (202)	■	■	
Black Diamond F (215)	■	■	■
Jet (280)	■	■	
Light Siam F (227)	■	■	■
Crystal Effects			
Transparent Effects			
Crystal AB F (001 AB)	■	■	■
Crystal Silver Shade F (001 SSHA)	■	■	
Color Effects			
Metallic Effects			
Jet Hematite (280 HEM)	■	■	■

Crystal

Crystal F (001)

Colors

Plain Colors

Aquamarine F (202)

Black Diamond F (215)

Jet (280)

Light Siam F (227)

Crystal Effects

Transparent Effects

Crystal AB F (001 AB)

Crystal Silver Shade F (001 SSHA)

Color Effects

Metallic Effects

Jet Hematite (280 HEM)

2777 CONCISE HEXAGON FB



Siz	MM 5,0X 4,2	MM 6,7X 5,6	MM 10,0X 8,4
-----	-------------	-------------	--------------

Crystal

Crystal F (001)	■	■	■
-----------------	---	---	---

Colors

Plain Colors

Aquamarine F (202)	■	■	
--------------------	---	---	--

Black Diamond F (215)	■	■	■
-----------------------	---	---	---

Jet (280)	■	■	
-----------	---	---	--

Light Siam F (227)	■	■	■
--------------------	---	---	---

Crystal Effects

Transparent Effects

Crystal AB F (001 AB)	■	■	■
-----------------------	---	---	---

Crystal Silver Shade F (001 SSHA)	■	■	
-----------------------------------	---	---	--

Color Effects

Metallic Effects

Jet Hematite (280 HEM)	■	■	■
------------------------	---	---	---

DIAMOND LEAF¹

DESIGNER EDITION

Swarovski and Giorgio Armani worked together to create an exclusive crystal called Diamond Leaf. This Designer Edition has a fluid, organic shape reminiscent of a leaf. Precision-cut facets melt into the softness of a floating, sculptural form, contrasting strength and fragility, the timeless with the ethereal.

Giorgio Armani: "Swarovski crystal brings a touch of magic to a dress, an ethereal quality, a luster that never fails to captivate the attention."

2797 Diamond Leaf Flat Back¹

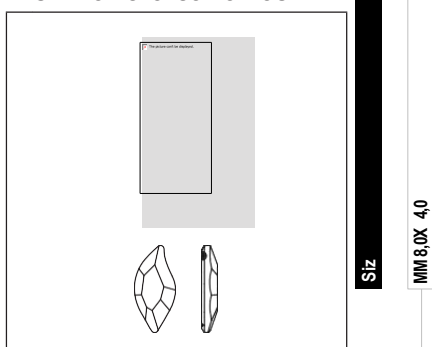

Crystal

Crystal F (001)

Crystal Effects

Transparent Effects

Crystal AB F (001 AB)

THE DIAMOND LEAF DESIGNER EDITION FAMILY



2797
8x4 mm

chapter07 Flat Back No Hotfix
p. 397



3254
20x9, 30x14 mm

chapter09 Sew-on Articles
p. 455

DESIGNER EDITIONS – DISTINCT PACKAGING

This Designer Edition will be labeled with the "Designer Edition" imprint directly on the packaging.

¹ Article consists of Advanced Crystal

2798 Contour Flat Back

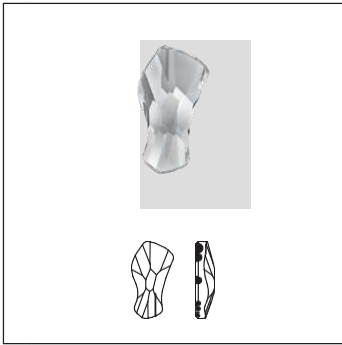

Siz	MM 8,0	MM 10,0	MM 14,0
-----	--------	---------	---------

Crystal			
Crystal F (001)	■	■	■
Colors			
Opal Colors			
White Opal F (234)	■	■	■
Crystal Effects			
Transparent Effects			
Crystal AB F (001 AB)	■	■	■
Crystal Silver Night (001 SINI)	■	■	■

2808 Heart Flat Back

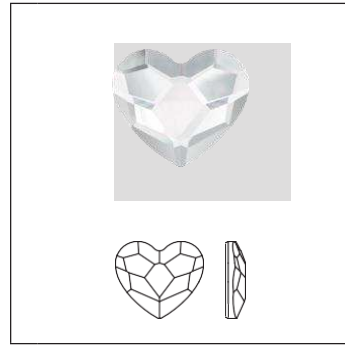

Siz	MM 3,6	MM 6,0	MM 10,0	MM 14,0
-----	--------	--------	---------	---------

Crystal				
Crystal F (001)	■	■	■	■
Colors				
Plain Colors				
Denim Blue F (266)		■	■	■
Fuchsia F (502)	■	■	■	■
Jet (280)	■	■	■	■
Light Siam F (227)		■	■	■
Light Silk F (261)		■	■	■
Rosaline F (508)		■	■	■
Crystal Effects				
Transparent Effects				
Crystal Antique Pink F (001 ANTP)	■	■	■	■
Crystal AB F (001 AB)	■	■	■	■
Crystal Golden Shadow F (001 GSHA)	■	■	■	■
Crystal Lacquer <sup>Pro</sup>				
Crystal Royal Red (001 L107S)	■	■	■	■

2813 Moon Flat Back

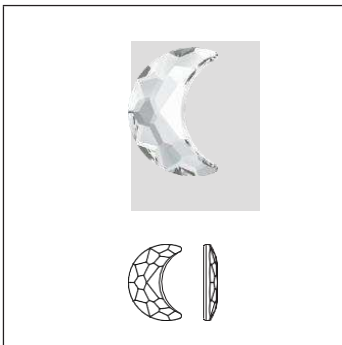

Siz	MM 8,0X 5,5	MM 10,0X 7,0
-----	-------------	--------------

Crystal		
Crystal F (001)	■	■
Colors		
Plain Colors		
Jet (280)	■	■
Light Colorado Topaz F (246)	■	■
Light Siam F (227)	■	■
Crystal Effects		
Transparent Effects		
Crystal AB F (001 AB)	■	■

2816 Rivoli Star Flat Back

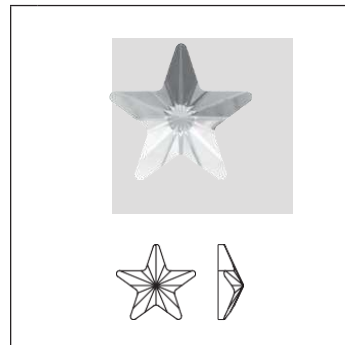

Siz	MM 5,0
-----	--------

Crystal	
Crystal F (001)	■
Crystal Effects	
Transparent Effects	
Crystal AB F (001 AB)	■

2826 Rivoli Snowflake Flat Back

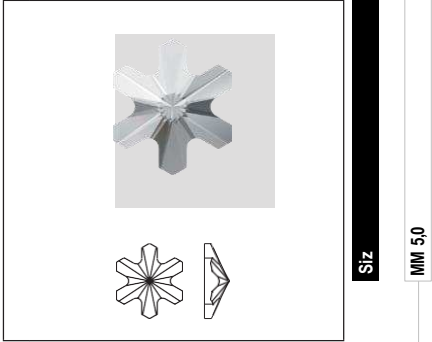

Siz

MM 5,0

- Crystal
- Crystal F (001)
- Crystal Effects
- Transparent Effects
- Crystal AB F (001 AB)

2854 Butterfly Flat Back

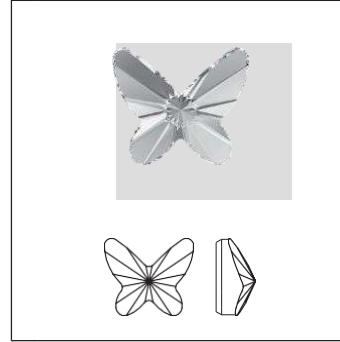

Siz

MM 8,0

MM 12,0

- Crystal
- Crystal F (001)
- Colors
- Plain Colors
- Amethyst F (204)
- Denim Blue F (266)
- Light Rose F (223)
- Crystal Effects
- Transparent Effects
- Crystal AB F (001 AB)
- Crystal Silver Night F (001 SINI)

2856 Skull Flat Back

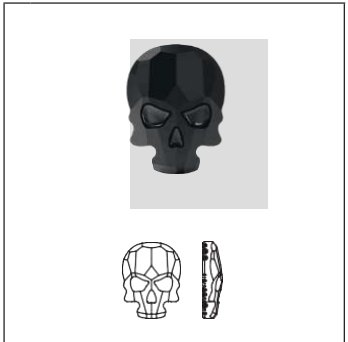

Siz

MM 10,0X 7,5

MM 14,0X 10,5

MM 18,0X 14,0

- Colors
- Plain Colors
- Jet (280)
- Crystal Effects
- Transparent Effects
- Crystal AB F (001 AB)
- Crystal Golden Shadow F (001 GSHA)
- Crystal Silver Night (001 SINI)
- Metallic Effects
- Crystal Light Chrome F (001 LTCH)
- Crystal Metallic Blue F (001 METBL)
- Crystal Metallic Light Gold F (001 MLGLD)
- Color Effects
- Jet Hematite (280 HEM)

2858 BowTie Flat Back

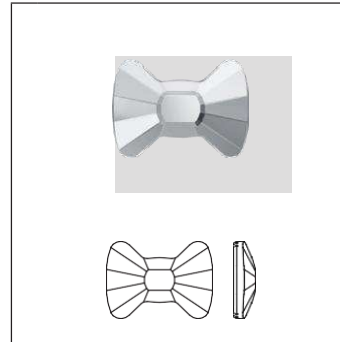

Siz

MM 16,0X 4,5

MM 19,0X 6,5

- Crystal
- Crystal F (001)
- Crystal Effects
- Transparent Effects
- Crystal AB F (001 AB)

2196/4 Oval Cabochon



- Crystal Effects**
- Transparent Effects**
- Crystal Golden Shadow VL F (001 GHAVL)
- Crystal Satin Moroda F (001 SATMO)
- Crystal Satin Tabak F (001 SATTA)
- Crystal Lacquer ^{Pro}**
- Crystal Mint Green (001 L115S)
- Crystal Ocean DeLite (001 L143D)
- Crystal Peony Pink (001 L113S)
- Crystal Powder Grey AB (001 L105A)

2208/4 xxx

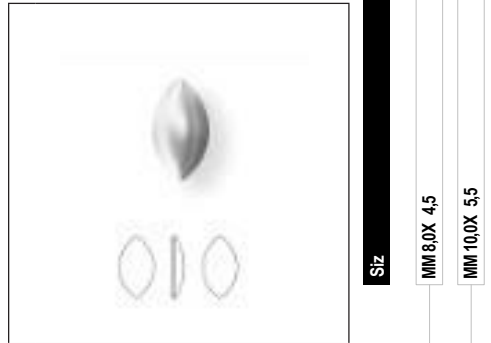

- Crystal**
- Crystal Creampearl F (001 CMPRL)
- Crystal Effects**
- Metallic Effects**
- Crystal Light Chrome F (001 LTCH)
- Colors**
- Crystal Nacre F (001 NACRE)
- Crystal White Pearl F (001 650)

2308/4 xxx



- Crystal**
- Crystal Creampearl F (001 CMPRL)
- Crystal Effects**
- Metallic Effects**
- Crystal Light Chrome F (001 LTCH)
- Colors**
- Crystal Nacre F (001 NACRE)
- Crystal White Pearl F (001 650)

2408/4 xxx

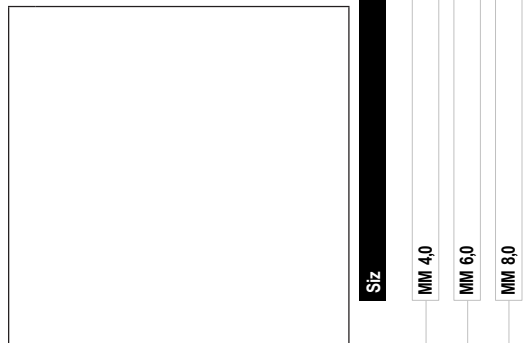

- Crystal**
- Crystal Creampearl F (001 CMPRL)
- Crystal Effects**
- Metallic Effects**
- Crystal Light Chrome F (001 LTCH)
- Colors**
- Crystal Nacre F (001 NACRE)
- Crystal White Pearl F (001 650)

PRODUCT DETAILS

Article Size	Packing Unit = Minimum Order Quantity in Pieces	Average Net Weight in Gram per Packing Unit Crystal (001)	Average Gross Weight in Gram per Packing Unit Crystal (001)
2000			
SS 3	1,440	1.8	12.7
SS 4	1,440	3.3	13.7
2006			
10 mm	288	89.9	116.4
12 mm	144	87.2	110.9
14 mm	144	132.4	158.7
16 mm	144	188.6	222.4
2034			
SS 10	1440	10.9	19.3
SS 20	1440	40.7	49.2
SS 48	96	39.8	64.8
2035			
6 mm	360	27.1	34.8
10 mm	192	56.2	88.0
14 mm	96	88.4	109.0
20 mm	40	82.0	121.4
30 mm	12	95.4	130.8
40 mm	6	105.3	140.3
2058			
SS 5	1,440	4.4	17.9
SS 6	1,440	5.7	17.6
SS 7	1,440	7.1	19.0
SS 8	1,440	10.1	19.6
SS 9	1,440	12.4	22.0
SS 10	1,440	15.8	25.3
2072			
8 mm	288	92.9	119.6
10 mm	144	90.6	111.0
12 mm	72	82.0	100.1
2088			
SS 12	1,440	22.1	30.3
SS 14	1,440	30.1	38.3
SS 16	1,440	39.9	49.8
SS 20	1,440	72.2	80.9
SS 24	1,440	127.12	136.3
SS 30	288	34.6	63.0
SS 34	144	25.9	48.6
SS 40	144	50.0	75.1
SS 48	96	76.1	101.3
2088/1			
SS 16	1440	44.69	53.86
SS 20	1440	80.06	89.98
SS 34	144	25.97	44.26
2200			
4x2 mm	720	6.5	18.5
8x4 mm	720	49.6	60.2
2201			
8x3.5 mm	144	10.03	31.11
14x6 mm	72	21.67	45.27

Article Size	Packing Unit = Minimum Order Quantity in Pieces	Average Net Weight in Gram per Packing Unit Crystal (001)	Average Gross Weight in Gram per Packing Unit Crystal (001)
2204			
6x4.8 mm	360	27.2	36.4
10x8 mm	144	31.5	53.3
2205			
7.5 mm	288	20.3	30.5
10 mm	144	17.6	42.4
14 mm	72	22.3	45.9
2300			
8x4.8 mm	720	83.9	94.5
10x6 mm	360	56.9	67.8
2303			
8x5 mm	144	15.70	39.60
14x9 mm	72	36.65	60.25
2304			
10x2.8 mm	180	10.3	20.5
14x3.9 mm	96	13.1	36.3
6x1.7 mm	360	7.5	16.2
2400			
2.2 mm	1,440	11.3	21.7
3 mm	1,440	25.3	36.8
4 mm	720	30.0	41.0
6 mm	144	21.6	32.5
10 mm	72	37.2	61.0
2402			
4 mm	720	22.3	33.1
6 mm	144	15.1	25.9
10 mm	72	30.5	54.1
2403			
4 mm	720	32.2	43.1
6 mm	144	21.9	32.8
10 mm	72	42.7	66.4
2420			
10 mm	144	91.6	118.2
25 mm	32	200.8	251.8
2483			
10 mm	144	90.3	120.2
25 mm	32	233.3	261.5
2493			
8 mm	216	72.3	91.8
10 mm	144	84.4	106.1
20 mm	24	108.5	137.9
2494			
6 mm	220	22.3	31.5
8 mm	144	29.5	50.2
2520			
8x6 mm	288	50.8	80.2
10x8 mm	144	72.3	90.4
14x10 mm	144	119.3	140.8

Article Size	Packing Unit = Minimum Order Quantity in Pieces	Average Net Weight in Gram per Packing Unit Crystal (001)	Average Gross Weight in Gram per Packing Unit Crystal (001)
2540			
7x5.5 mm	240	39.7	43.6
2555			
8x2.6 mm	240	18.4	27.5
12x4 mm	144	28.8	33.6
15x5 mm	72	28.9	46.0
2570			
50x16 mm	6	52.9	81.6
2585			
8 mm	288	48.2	68.1
10 mm	288	72.3	104.3
2602			
8x5.5 mm	144	17.89	41.79
14x10 mm	72	58.61	82.21
2709			
10x6 mm	288	48.2	73.6
13x8 mm	144	41.0	60.1
2711			
3.3 mm	720	10.2	16.4
2714			
6 mm	360	38.8	49.7
10 mm	144	59.8	84.3
2716			
5 mm	720	35.8	75.1
2720			
7.5 mm	240	27.9	37.0
9 mm	180	45.1	54.2
12.5 mm	144	71.1	87.1
2304			
6x1.7 mm	360	7.5	16.2
2738			
10x5 mm	144	16.7	35.1
12x6 mm	96	20.2	38.3
2739			
5.8x5.3 mm	216	19.2	41.9
7x6.5 mm	144	22.6	39.8
2740			
8.3x8.3 mm	216	35.1	54.2
10x10 mm	96	25.1	41.1
2753			
10 mm	72	19.6	40.4
2770			
6x3.5 mm	1,440	60.3	70.3
12x7 mm	192	49.8	98.4

Article Size	Packing Unit = Minimum Order Quantity in Pieces	Average Net Weight in Gram per Packing Unit Crystal (001)	Average Gross Weight in Gram per Packing Unit Crystal (001)
2771			
6.4x4.2 mm	288	9.04	17.87
8.6x5.6 mm	216	16.84	43.02
12.9x8.3 mm	144	36.29	61.39
2772			
6.5x2.1 mm	288	6.39	15.17
8.6x2.8 mm	288	16.29	40.71
12.9x4.2 mm	144	25.57	53.86
2773			
5x3 mm	288	4.83	13.66
6.6x3.9 mm	288	11.23	35.65
9.9x5.9 mm	144	19.30	43.39
2797			
8x4 mm	240	14.9	24.0
2798			
8 mm	360	23.0	33.2
10 mm	144	21.4	44.7
14 mm	108	55.1	83.5
2808			
6 mm	288	19.8	28.9
10 mm	144	38.8	55.9
14 mm	96	56.4	86.8
2813			
8x5.5 mm	144	13.1	37.7
10x7 mm	144	23.0	47.6
2816			
5 mm	720	23.6	30.7
2826			
5 mm	720	23.1	30.1
2854			
8 mm	216	36.0	52.2
12 mm	144	84.4	103.8
2856			
10x7.5 mm	72	20.2	38.6
14x10.5 mm	36	30.2	50.3
18x14 mm	30	53.0	83.4
2858			
6x4.5 mm	240	12.5	21.7
9x6.5 mm	144	23.4	44.1



FLAT BACKS HOTFIX

Flat Backs Hotfix are loose crystal elements with a flat reverse side that has been pre-coated with a heat-sensitive glue. These Flat Backs can be easily applied to a large range of textile carrier materials using heat to produce a durable and long-lasting crystal effect.

Flat Backs Hotfix are available in a multitude of colors, shapes, and cuts. The increased light reflection and warmer appearance of the Flat Back Rose are achieved through a special silver mirror on the reverse side.

The most innovative single item in this product group is art. 2078 XIRIUS Rose, with the most progressive and unique cut on the market: multilayer cut technology, producing the inspiring XIRIUS star design. Superior shine and rich, well-balanced refraction of light redefine the market standard.

Swarovski's outstanding quality in crystal elements is underlined by the highest precision in table size and diameter.

Amethyst (204)
 Aquamarine (202)
 Black Diamond (215)
 Black Diamond Dorado Z (215 DORZ) Black
 Diamond Light Chrome Z (215 LTCHZ) Black
 Diamond Shimmer (215 SHIM)
 Blue Zircon (229)
 Blue Zircon Satin (229 SAT)
 Blue Zircon Shimmer (229 SHIM)
 Blush Rose (257)
 Burgundy (515)
 Burgundy Dorado Z (515 DORZ)
 Burgundy Light Chrome Z (515 LTCHZ)
 Capri Blue (243)
 Chalkwhite (279)
 Chrysofite (238)
 Citrine (249)
 Citrine Shimmer (249 SHIM)
 Cobalt (369)
 Cobalt Shimmer (369 SHIM)
 Crystal (001)
 Crystal Shimmer (001 SHIM)
 Crystal Army Green Delite (001 L130D)*
 Crystal Aurore Boreale (001 AB)
 Crystal Azure Blue (001 L112S)
 Crystal Bermuda Blue (001 BBL)
 Crystal Black Patina (001 BLAPA)
 Crystal Blue Shade (001 BLSH)
 Crystal Bronze Pearl (001 295)
 Crystal Burgundy Delite (001 L132D)*
 Crystal Buttercup (001 L124S)
 Crystal Cappuccino Delite (001 L133D)*
 Crystal Copper (001 COP)
 Crystal Creampearl (001 291)
 Crystal Dark Grey Pearl (001 617)
 Crystal Dark Grey (001 L111S)
 Crystal Dark Red (001 L108S)
 Crystal Dorado (001 DOR)
 Crystal Dorado Z (001 DORZ) Crystal
 Golden Shadow (001 GSHA) Crystal
 Hotfix Transparent (001 HFT)²
 Crystal Iridescent Dove Grey Pearl (001 954)
 Crystal Iridescent Green (001 IIRIG)
 Crystal Ivory Cream (001 L106S)
 Crystal Light Chrome (001 LTCH)
 Crystal Light Chrome Z (001 LTCHZ)
 Crystal Light Coral (001 L116S)
 Crystal Light Grey Delite (001 L129D)*
 Crystal Light Grey Pearl (001 616)
 Crystal Lilac (001 L126S)
 Crystal Lime (001 L125S)
 Crystal Luminous Green (001 LUMG)
 Crystal Meridian Blue (001 MBL)

Crystal Metallic Blue (001 METBL) Crystal
 Metallic Light Gold (001 MLGLD) Crystal
 Metallic Sunshine (001 METSH) Crystal
 Mint Green (001 L115S)
 Crystal Moonlight (001 MOL)
 Crystal Naere (001 191)
 Crystal Ochre Delite (001 L131D)*
 Crystal Paradise Shine (001 PARSH)*
 Crystal Peony Pink (001 L113S)
 Crystal Rosaline Pearl (001 294)
 Crystal Rainbow Dark (001 RABDK)
 Crystal Rose Gold (001 ROGL)
 Crystal Rose Gold Pearl (001 769)
 Crystal Rose Patina (001 ROSPA)
 Crystal Royal Blue (001 L110S)
 Crystal Royal Green (001 L109S)
 Crystal Royal Red (001 L107S)
 Crystal Scarabaeus Green (001 SCGR)***
 Crystal Silver Night (001 SINI)
 Crystal Silver Shade (001 SSHA)
 Crystal Summer Blue (001 L114S)
 Crystal Transmission Hotfix Transparent (001 TRAHFT)
 Crystal Vintage Gold Pearl (001 651)
 Crystal Volcano (001 VOL)
 Crystal White Pearl (001 650)
 Dark Indigo (288)
 Denim Blue (266)
 Denim Blue Dorado Z (266 DORZ)
 Denim Blue Light Chrome Z (266 LTCHZ)
 Emerald (205)
 Erintite (360)
 Erintite Shimmer (360 SHIM)
 Fern Green (291)
 Fireopal (237)²
 Fuchsia (502)
 Fuchsia Shimmer (502 SHIM)
 Graphite (253)
 Greige (284)
 Greige Dorado Z (284 DORZ)
 Greige Light Chrome Z (284 LTCHZ)
 Hyacinth (236)
 Hyacinth Shimmer (236 SHIM)
 Indian Pink (289)
 Indian Siam (327)²
 Jet (280)
 Jet Aurore Boreale (280 AB)
 Jet Dorado Z (280 DORZ)
 Jet Hematite (280 HEM)
 Jet Light Chrome Z (280 LTCHZ)
 Jet Nut (280 NUT)
 Jonquill (213)
 Jonquill Aurore Boreale (213 AB)
 Khaki (550)

Khaki Dorado Z (550 DORZ) Khaki
 Light Chrome Z (550 LTCHZ) Light
 Amethyst (212)
 Light Colorado Topaz (246)
 Light Colorado Topaz Shimmer (246 SHIM)
 Light Grey Opal (383)
 Light Peach (362)
 Light Rose (223)
 Light Rose Aurore Boreale (223 AB)
 Light Sapphire (211)
 Light Sapphire Shimmer (211 SHIM)
 Light Siam (227)
 Light Siam Aurore Boreale (227 AB)
 Light Siam Dorado Z (227 DORZ)
 Light Siam Light Chrome Z (227 LTCHZ)
 Light Siam Shimmer (227 SHIM)
 Light Silk (261)
 Light Topaz (226)
 Light Topaz Shimmer (226 SHIM)
 Light Turquoise (263)
 Majestic Blue (296)¹
 Montana (207)
 Olivine (228)
 Pacific Opal (390)
 Padparadscha (542)
 Peridot (214)
 Peridot Shimmer (214 SHIM)
 Provence Lavender (283)
 Purple Velvet (277)
 Rose (209)
 Rose Peach (262)
 Ruby (501)
 Sapphire (206)
 Sapphire Aurore Boreale (206 AB)
 Sapphire Satin (206 SAT)
 Scarlet (276)
 Siam (208)
 Siam Shimmer (208 SHIM)
 Silk (391)
 Silk Shimmer (391 SHIM)
 Smoked Topaz (220)
 Sunflower (292)
 Tangerine (259)
 Tangerine Shimmer (259 SHIM)
 Tanzanite (539)
 Topaz (203)
 Topaz Shimmer (203 SHIM)
 Vintage Rose (319)
 White Opal (234)
 White Opal Dorado Z (234 DORZ)
 White Opal Light Chrome Z (234 LTCHZ)
 Yellow Opal (231)

For details on available colors and effects for each article within the product groups, please see the product matrix of the respective item in the Collection 2018.

For color and effect samples, please see the corresponding color chart.

The plating resistance of effects is tested according to Swarovski's plating guidelines (SWAROVSKI-PROFESSIONAL.COM). Customers are advised to carry out their own tests if their plating parameters diverge from Swarovski plating guidelines.

* Crystals are not resistant to plating and similar processing.

** Crystals are resistant to plating only if they are F-foiled.

*** designed by Jean Paul Gaultier

¹ Majestic Blue's intense ultramarine hue is difficult to recreate accurately in print due to the fact that the CMYK color spectrum is used in the printing process.

In order to get a truer impression of its color, please use RGB digital pictures or, ideally, ask for actual samples.

² Only available in limited sizes.

³ In these colors art. 2088 is available as a foiled or unfoiled version.

Classic Colors/Effects: This color range offers a wide choice of traditional Swarovski crystal colors and effects.

Exclusive Colors/Effects: This color range is offered exclusively by Swarovski.

Colors and effects can appear different when illuminated with different light sources. Swarovski uses standard light source D50 for color decision and comparison. Slight changes in shades are unavoidable. Colors may vary according to cut and foiling.

The composition of Advanced Crystal is compliant with regulatory industry norms and laws regarding the restriction or prohibition of certain substances in the most relevant segments of our customers. Please note that the compliance of the crystal colors Citrine, Fireopal, Hyacinth, Light Siam, Siam, and Yellow Opal varies according to certain industry regulations. Those regulations are indicated with * in the compliance overview. Indian Siam and Scarlet (option to Lt. Siam) conform to all CLEAR-lists.



For further information please visit: SWAROVSKI-PROFESSIONAL.COM

Communication on Product-Assortment changes*

IMPORTANT INFORMATION ON ASSORTMENT ADJUSTMENTS

We would kindly like to inform you about overall portfolio streamlining as well as discontinuations of selected product lines, effective as of November 23rd, 2020.

In order to allow you sufficient time to prepare, upcoming changes are already visible in our B2B e-commerce platform. During this transition phase the collection has been marked with the following caption:

Caption - SUMMARY	
	OUT OF ASSORTMENT
	CHANGES IN THE ASSORTMENT
	NO CHANGES IN THE ASSORTMENT













































Caption - MATRIX	
	OUT OF ASSORTMENT
	FUTURE MADE TO ORDER ITEM - MTO
	FUTURE MADE TO STOCK ITEM - MTS

*ASSORTMENT WILL BE VALID DURING THE TRANSITION PHASE: **NOV 23rd 2020 – March 31st 2021**
SMALL CHANGES CAN ACCURE DURING THIS TRANSITION PHASE

SUMMARY

1	2		1	2		1	2	
		2000 A HF SS 3			2200/I M HF 8x4 mm			2408/4 M HF 4, 6, 8 mm
		2019 4, 5, 6 mm			2201 M HF 8x3.5, 14x6 mm			2419 4, 5, 6 mm
		2034 A HF SS 10, 20, 48			2205 M HF 7.5, 10, 14 mm			2493 M HF 8, 10, 12 mm
		2035 M HF 6, 10 mm			2208/4 M HF 6x3.5, 8x4.5, 10x5.5 mm			2471 5, 7, 10 mm
		2038 A HF SS 5, 6, 8, 10			2300 M HF 8x4.8 mm			2494 M HF 6, 8, 10.5 mm
		2038/I A HF SS 10			2300/I M HF 8x4.8 mm			2510 M HF 3.7x1.9, 5x2.5 mm
		2078 A HF SS 12, 16, 20, 30, 34, 40, 46			2303 8x5, 14x9 mm			2555 M HF 8x2.6, 12x4, 15x5 mm
		2078/H A HF SS 16, 20, 34			2304 M HF 10x2.8 mm			2602 8x5.5, 14x10 mm
		2078/I A HF SS 16, 20, 34			2308/4 M HF 6x3.5, 8x5, 10x6 mm			2610 M HF 6x4 mm
		2080/4 HF SS 10, 16, 34			2400 M HF 2.2, 3, 4, 6, 10 mm			2709 M HF 10x6 mm
		2080/H M HF SS 34			2402 M HF 4, 6, 10 mm			2711 M HF 3.3, 6 mm
		2081/2 M HF SS 10, 16, 34			2403 M HF 4, 6, 10 mm			2711/I M HF 6 mm
		2200 M HF 4x2, 8x4 mm			2364 6x3.7, 10x6, 14x8.5 mm			2714 M HF 6, 10 mm
		2365 6x3.7, 10x6, 14x8.5 mm			2716 M HF 5 mm			

SUMMARY

1	2	 	2728 M HF SS 10, 16, 20, 34	1	2	 	2816 M HF 5 mm
		 	2738 M HF 10x5, 12x6 mm			 	2817 M HF 5 mm
		 	2739 M HF 5.8x5.3, 7x6.5 mm			 	2826 M HF 5 mm
		 	2740 M HF 8.3x8.3, 10x10 mm			 	2855 M HF 8 mm
		 	2753 M HF 10, 14 mm			 	2856 M HF 10x7.5, 14x10.5, 18x14 mm
		 	2770 M HF 6x3.5 mm			 	2858 M HF 6x4.5 mm
		 	2771 M HF 6.4x4.2, 8.6x5.6, 12.7x8.3 mm			 	2774 6.3x4.2, 8.3x5.6, 12.5x8.4 mm
		 	2772 M HF 6.5x2.1, 8.6x2.8, 12.7x4.2 mm			 	2775 5x4.2, 6.7x5.6, 10x8.4 mm
		 	2773 M HF 5x3, 6.6x3.9, 7.7x5.7 mm			 	2776 8.2x4.2, 11x5.6, 16.5x8.4 mm
		 	2788 M HF 8, 10 mm			 	2777 5x4.2, 6.7x5.6, 10x8.4 mm
		 	2808 M HF 3.6, 6, 10 mm				
		 	2813 M HF 8x5.5 mm				

2000 RoseHofix

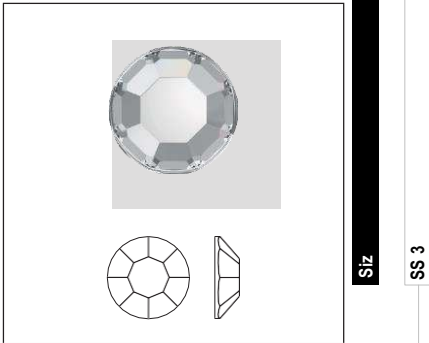

Siz

SS 3

Crystal

Crystal A HF (001)

Colors

Plain Colors

Amethyst A HF (204)

Aquamarine A HF (202)

Black Diamond A HF (215)

Jet A HF (280)

Light Colorado Topaz A HF (246)

Light Rose A HF (223)

Montana A HF (207)

Peridot A HF (214)

Smoked Topaz A HF (220)

Crystal Effects

Transparent Effects

Crystal AB A HF (001 AB)

Crystal Golden Shadow A HF (001 GSHA)

Crystal Silver Shade A HF (001 SSHA)

Color Effects

Metallic Effects

Jet Hematite A HF (280 HEM)

2019 ConciseFlatBack



Siz

MM 4,0X 4,0

MM 5,0X 5,0

MM 6,0X 6,0

Crystal

Crystal M HF (001)

Crystal Effects

Transparent Effects

Crystal AB M HF (001 AB)

Crystal Blue Shade M HF (001 BLSH)

Crystal Golden Shadow M HF (001 GSHA)

Crystal Volcano M HF (001 VOL)

Color Effects

Black Diamond Shimmer M HF (215 SHIM)

Light Topaz Shimmer M HF (226 SHIM)

2034 Concise Flat Back

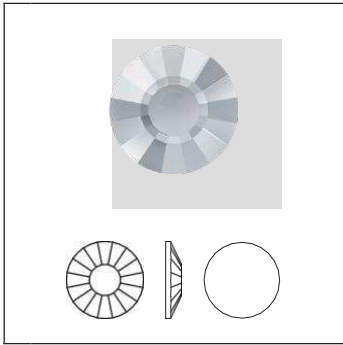

Siz	SS 10	SS 20	SS 48
-----	-------	-------	-------

Crystal			
Crystal A HF (001)	■	■	■
Colors			
Plain Colors			
Jet A HF (280)	■	■	■
Light Siam A HF (227)	■	■	
Crystal Effects			
Transparent Effects			
Crystal AB A HF (001 AB)	■	■	■
Crystal Golden Shadow A HF (001 GSHA)	■	■	
Metallic Effects			
Crystal Light Chrome A HF (001 LTCH)	■	■	
Crystal Patina			
Crystal Black Patina A HF (001 BLAPA)		■	■
Crystal Rose Patina A HF (001 ROSPA)		■	■
Color Effects			
Light Siam AB A HF (227 AB)	■	■	■

2035 Chessboard Circle Flat Back

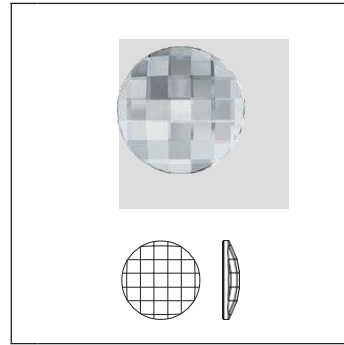

Siz	MM 6,0	MM 10,0
-----	--------	---------

Crystal		
Crystal M HF (001)	■	■
Crystal Effects		
Transparent Effects		
Crystal AB M HF (001 AB)	■	■

CORE ASSORTMENT

2038 XILION Rose Halfix

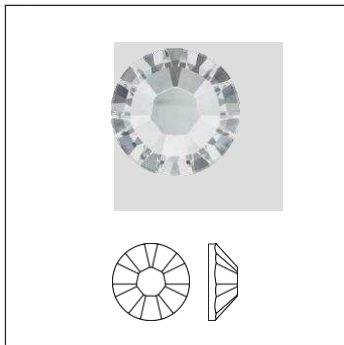

Size	SS 5	SS 6	SS 8	SS 10
------	------	------	------	-------

Crystal

Crystal HFT (001)		■	■	■
Crystal A HF (001)	■	■	■	■

Colors

Plain Colors

Amethyst A HF (204)	■	■	■	■
Aquamarine HFT (202)			■	
Aquamarine A HF (202)	■	■	■	■
Black Diamond A HF (215)	■	■	■	■
Blue Zircon A HF (229)		■	■	■
Blush Rose A HF (257)		■	■	■
Burgundy A HF (515)		■	■	■
Capri Blue A HF (243)		■	■	■
Chalkwhite A HF (279)		■	■	■
Chrysolite A HF (238)		■	■	■
Citrine A HF (249)		■	■	■
Cobalt A HF (369)		■	■	■
Dark Indigo A HF (288)		■	■	■
Denim Blue A HF (266)		■	■	■
Emerald A HF (205)	■	■	■	■
Erinite A HF (360)		■	■	■
Fern Green A HF (291)		■	■	■
Fireopal A HF (237)				■
Fuchsia A HF (502)		■	■	■
Graphite A HF (253)		■	■	■
Greige A HF (284)		■	■	■
Hyacinth A HF (236)		■	■	■
Indian Pink A HF (289)		■	■	■
Indian Siam A HF (327)		■	■	■
Iris A HF (219)		■	■	■
Jet A HF (280)	■	■	■	■
Jonquil A HF (213)		■	■	■
Khaki A HF (550)		■	■	■
Light Amethyst A HF (212)		■	■	■
Light Colorado Topaz A HF (246)	■	■	■	■

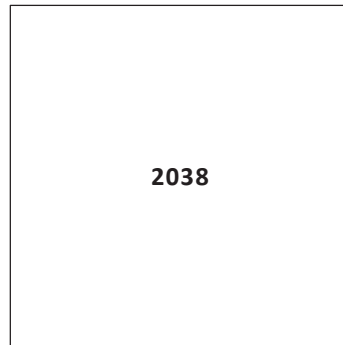

Size	SS 5	SS 6	SS 8	SS 10
------	------	------	------	-------

Light Peach A HF (362)		■	■	■
Light Rose A HF (223)	■	■	■	■
Light Sapphire A HF (211)		■	■	■
Light Siam A HF (227)		■	■	■
Light Silk A HF (261)		■	■	■
Light Topaz A HF (226)		■	■	■
Light Turquoise A HF (263)		■	■	■
Majestic Blue A HF (296)		■	■	■
Montana A HF (207)		■	■	■
Olivine A HF (228)		■	■	■
Padparadscha A HF (542)		■	■	■
Peridot A HF (214)		■	■	■
Provence Lavender A HF (283)		■	■	■
Purple Velvet A HF (277)		■	■	■
Rose A HF (209)		■	■	■
Rose Peach A HF (262)		■	■	■
Ruby A HF (501)		■	■	■
Sapphire A HF (206)		■	■	■
Scarlet A HF (276)	■	■	■	■
Siam A HF (208)		■	■	■
Silk A HF (391)		■	■	■
Smoked Topaz A HF (220)		■	■	■
Sunflower A HF (292)		■	■	■
Tangerine A HF (259)		■	■	■
Tanzanite A HF (539)		■	■	■
Topaz A HF (203)		■	■	■
Vintage Rose A HF (319)		■	■	■
Opal Colors				
Light Grey Opal A HF (383)		■	■	■
Pacific Opal A HF (390)		■	■	■
White Opal A HF (234)		■	■	■
Yellow Opal A HF (231)		■	■	■
Crystal Effects				
Transparent Effects				
Crystal AB A HF (001 AB)	■	■	■	■

2038		Siz	SS 5	SS 6	SS 8	SS 10
	Crystal Blue Shade A HF (001 BLSH)			■	■	■
	Crystal Copper A HF (001 COP)		■	■	■	
	Crystal Golden Shadow A HF (001 GSHA)		■	■	■	
	Crystal Luminous Green A HF (001 LUMG)		■	■	■	
	Crystal Meridian Blue A HF (001 MBLUE)		■	■	■	
	Crystal Moonlight A HF (001 MOL)		■	■	■	
	Crystal Paradise Shine A HF (001 PARSH)		■	■	■	
	Crystal Shimmer A HF (001 SHIM)		■	■	■	
	Crystal Silver Night A HF (001 SINI)		■	■	■	
	Crystal Silver Shade A HF (001 SSHA)		■	■	■	
	Crystal Transmission HFT (001 TRAN)		■	■	■	
	Crystal Volcano A HF (001 VOL)		■	■	■	
Metallic Effects						
	Crystal Dorado A HF (001 DOR)		■	■	■	
	Crystal Light Chrome A HF (001 LTCH)		■	■	■	
	Crystal Metallic Blue A HF (001 METBL)		■	■	■	
	Crystal Metallic Light Gold A HF (001 MLGLD)		■	■	■	
	Crystal Metallic Sunshine A HF (001 METSH)		■	■	■	
	Crystal Rainbow Dark A HF (001 RABDK)		■	■	■	
	Crystal Rose Gold A HF (001 ROGL)		■	■	■	
	Crystal Scarabaeus Green A HF (001 SCGR)		■	■	■	
Crystal Lacquer <sup>Pro</sup>						
	Crystal Army Green DeLite HFT (001 L130D)					■
	Crystal Azure Blue HFT (001 L112S)					■
	Crystal Burgundy DeLite HFT (001 L132D)					■
	Crystal Buttercup HFT (001 L124S)					■
	Crystal Cappuccino DeLite HFT (001 L133D)					■
	Crystal Dark Grey HFT (001 L111S)					■
	Crystal Dark Red HFT (001 L108S)					■
	Crystal Elect. Blue DeLite HFT (001 L134D)					■
	Crystal Elect. Green DeLite HFT (001 L135D)					■
	Crystal Elect. Orange DeLite HFT (001 L136D)					■
	Crystal Elect. Pink DeLite HFT (001 L137D)					■
	Crystal Elect. Violet DeLite HFT (001 L148D)					■
	Crystal Elect. White DeLite HFT (001 L139D)					■

2038		Siz	SS 5	SS 6	SS 8	SS 10
	Crystal Elect. Yellow DeLite HFT (001 L138D)					■
	Crystal Electric Blue HFT (001 L134S)					■
	Crystal Electric Green HFT (001 L135S)					■
	Crystal Electric Orange HFT (001 L136S)					■
	Crystal Electric Pink HFT (001 L137S)					■
	Crystal Electric Violet HFT (001 L148S)					■
	Crystal Electric White HFT (001 L139S)					■
	Crystal Electric Yellow HFT (001 L138S)					■
	Crystal Ivory Cream HFT (001 L106S)					■
	Crystal Laguna DeLite HFT (001 L142D)					■
	Crystal Lavender DeLite HFT (001 L144D)					■
	Crystal Light Coral HFT (001 L116S)					■
	Crystal Light Grey DeLite HFT (001 L129D)					■
	Crystal Lilac HFT (001 L126S)					■
	Crystal Lime HFT (001 L125S)					■
	Crystal Lotus Pink DeLite HFT (001 L145D)					■
	Crystal Mint Green HFT (001 L115S)					■
	Crystal Ocean DeLite HFT (001 L143D)					■
	Crystal Ochre DeLite HFT (001 L131D)					■
	Crystal Orange Glow DeLite HFT (001 L146D)					■
	Crystal Peach DeLite HFT (001 L140D)					■
	Crystal Peony Pink HFT (001 L113S)					■
	Crystal Royal Blue HFT (001 L110S)					■
	Crystal Royal Blue DeLite HFT (001 L110D)					■
	Crystal Royal Green HFT (001 L109S)					■
	Crystal Royal Red HFT (001 L107S)					■
	Crystal Royal Red DeLite HFT (001 L107D)					■
	Crystal Silky Sage DeLite HFT (001 L147D)					■
	Crystal Summer Blue HFT (001 L114S)					■
	Crystal Sunshine DeLite HFT (001 L141D)					■
Color Effects						
	Black Diamond Shimmer A HF (215 SHIM)			■		■
	Blue Zircon Satin A HF (229 SATIN)			■	■	■
	Blue Zircon Shimmer A HF (229 SHIM)			■		■
	Citrine Shimmer A HF (249 SHIM)			■		■

2038		Size				
		SS 5	9 SS	8 SS	10 SS	
	Cobalt Shimmer A HF (369 SHIM)		■		■	
	Erinite Shimmer A HF (360 SHIM)		■		■	
	Fuchsia Shimmer A HF (502 SHIM)		■		■	
	Hyacinth Shimmer A HF (236 SHIM)		■		■	
	Jet AB A HF (280 AB)		■	■	■	
	Jonquil AB A HF (213 AB)		■	■	■	
	Light Colorado Topaz Shimmer A HF (246 SH)		■		■	
	Light Rose AB A HF (223 AB)		■	■	■	
	Light Rose Shimmer A HF (223 SHIM)		■		■	
	Light Sapphire Shimmer A HF (211 SHIM)		■		■	
	Light Siam AB A HF (227 AB)		■	■	■	
	Light Siam Shimmer A HF (227 SHIM)		■		■	
	Light Topaz Shimmer A HF (226 SHIM)		■		■	
	Peridot Shimmer A HF (214 SHIM)		■		■	
	Rose Peach Shimmer A HF (262 SHIM)		■		■	
	Sapphire AB A HF (206 AB)		■		■	
	Sapphire Satin A HF (206 SATIN)		■	■	■	
	Siam Shimmer A HF (208 SHIM)		■		■	
	Silk Shimmer A HF (391 SHIM)		■		■	
	Tangerine Shimmer A HF (259 SHIM)		■		■	
	Tanzanite Shimmer A HF (539 SHIM)		■		■	
	Topaz Shimmer A HF (203 SHIM)		■		■	
	Jet Hematite A HF (280 HEM)	■	■	■	■	
	Jet Nut A HF (280 NUT)		■	■	■	

2038/1 RimmedFlatBack

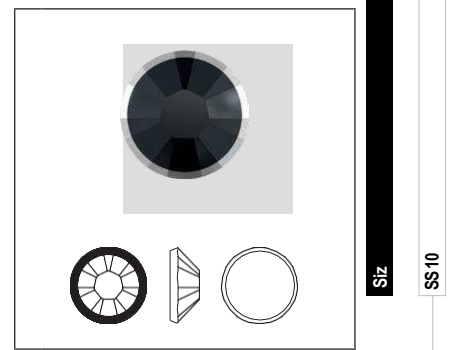

2038/1 RimmedFlatBack		Size	
		01 SS	
Crystal Effects			
Metallic Effects			
	Crystal Dorado Z A HF (001 DORZ)		■
	Crystal Light Chrome Z A HF (001 LTCHZ)		■
Color Effects			
	Black Diamond Dorado Z A HF (215 DORZ)		■
	Black Diamond Light Chrome Z A HF (215 LTCHZ)		■
	Burgundy Dorado Z A HF (515 DORZ)		■
	Burgundy Light Chrome Z A HF (515 LTCHZ)		■
	Denim Blue Dorado Z A HF (266 DORZ)		■
	Denim Blue Light Chrome Z A HF (266 LTCHZ)		■
	Greige Dorado Z A HF (284 DORZ)		■
	Greige Light Chrome Z A HF (284 LTCHZ)		■
	Jet Dorado Z A HF (280 DORZ)		■
	Jet Light Chrome Z A HF (280 LTCHZ)		■
	Khaki Dorado Z A HF (550 DORZ)		■
	Khaki Light Chrome Z A HF (550 LTCHZ)		■
	Light Siam Dorado Z A HF (227 DORZ)		■
	Light Siam Light Chrome Z A HF (227 LTCHZ)		■
	White Opal Dorado Z A HF (234 DORZ)		■
	White Opal Light Chrome Z A HF (234 LTCHZ)		■

CORE ASSORTMENT

2078 XIRIUS Rose Hotfix

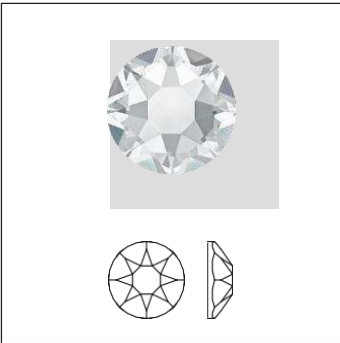

Siz	SS 12	SS 16	SS 20	SS 30	SS 34	SS 40	SS 48
-----	-------	-------	-------	-------	-------	-------	-------

Crystal

































Crystal HFT (001)		■					
Crystal A HF (001)	■	■	■	■	■	■	■

Colors

Plain Colors

Amethyst A HF (204)	■	■	■	■	■		
Aquamarine A HF (202)	■	■	■	■	■		
Black Diamond A HF (215)	■	■	■	■	■		
Blue Zircon A HF (229)	■	■	■		■		
Blush Rose A HF (257)	■	■	■		■		
Burgundy A HF (515)	■	■	■		■		
Capri Blue A HF (243)	■	■	■		■		
Chalkwhite A HF (279)	■	■	■		■		
Chrysolite A HF (238)	■	■	■		■		
Citrine A HF (249)	■	■	■		■		
Cobalt A HF (369)	■	■	■		■		
Dark Indigo A HF (288)	■	■	■		■		
Denim Blue A HF (266)	■	■	■		■		
Emerald A HF (205)	■	■	■	■	■		
Erinite A HF (360)	■	■	■		■		
Fern Green A HF (291)	■	■	■		■		
Fireopal A HF (237)	■	■	■	■	■		
Fuchsia A HF (502)	■	■	■		■		
Graphite A HF (253)	■	■	■		■		
Greige A HF (284)	■	■	■		■		
Hyacinth A HF (236)	■	■	■		■		
Indian Pink A HF (289)	■	■	■		■		
Indian Siam A HF (327)	■	■	■		■		
Iris A HF (219)	■	■	■		■		
Jet A HF (280)	■	■	■	■	■		
Jonquil A HF (213)	■	■	■		■		
Khaki A HF (550)	■	■	■	■	■		
Light Amethyst A HF (212)	■	■	■		■		
Light Colorado Topaz A HF (246)	■	■	■	■	■		
Light Peach A HF (362)	■	■	■		■		

2078		Siz						
		SS 12	SS 16	SS 20	SS 30	SS 34	SS 40	SS 48
Light Rose A HF (223)		■	■	■	■	■	■	■
Light Sapphire A HF (211)		■	■	■	■	■	■	■
Light Siam A HF (227)		■	■	■	■	■	■	■
Light Silk A HF (261)		■	■	■	■	■	■	■
Light Topaz A HF (226)		■	■	■	■	■	■	■
Light Turquoise A HF (263)		■	■	■	■	■	■	■
Majestic Blue A HF (296)		■	■	■	■	■	■	■
Montana A HF (207)		■	■	■	■	■	■	■
Olivine A HF (228)		■	■	■	■	■	■	■
Padparadscha A HF (542)		■	■	■	■	■	■	■
Peridot A HF (214)		■	■	■	■	■	■	■
Provence Lavender A HF (283)		■	■	■	■	■	■	■
Purple Velvet A HF (277)		■	■	■	■	■	■	■
Rose A HF (209)		■	■	■	■	■	■	■
Rose Peach A HF (262)		■	■	■	■	■	■	■
Ruby A HF (501)		■	■	■	■	■	■	■
Sapphire A HF (206)		■	■	■	■	■	■	■
Scarlet A HF (276)		■	■	■	■	■	■	■
Siam A HF (208)		■	■	■	■	■	■	■
Silk A HF (391)		■	■	■	■	■	■	■
Smoked Topaz A HF (220)		■	■	■	■	■	■	■
Sunflower A HF (292)		■	■	■	■	■	■	■
Tangerine A HF (259)		■	■	■	■	■	■	■
Tanzanite A HF (539)		■	■	■	■	■	■	■
Topaz A HF (203)		■	■	■	■	■	■	■
Vintage Rose A HF (319)		■	■	■	■	■	■	■
Opal Colors								
Light Grey Opal A HF (383)		■	■	■	■	■	■	■
Pacific Opal A HF (390)		■	■	■	■	■	■	■
White Opal A HF (234)		■	■	■	■	■	■	■
Yellow Opal A HF (231)		■	■	■	■	■	■	■
Crystal Effects								
Transparent Effects								
Crystal AB A HF (001 AB)		■	■	■	■	■	■	■
Crystal Blue Shade A HF (001 BLSH)		■	■	■	■	■	■	■

2078		Siz						
		SS 12	SS 16	SS 20	SS 30	SS 34	SS 40	SS 48
	Crystal Copper A HF (001 COP)	■	■	■				■
	Crystal Golden Shadow A HF (001 GSHA)	■	■	■	■			■
	Crystal Luminous Green A HF (001 LUMG)	■	■	■				■
	Crystal Meridian Blue A HF (001 MBLUE)	■	■	■				■
	Crystal Moonlight A HF (001 MOL)	■	■	■				■
	Crystal Paradise Shine A HF (001 PARSH)	■	■	■				■
	Crystal Shimmer A HF (001 SHIM)		■	■				■
	Crystal Silver Night A HF (001 SINI)	■	■	■				■
	Crystal Silver Shade A HF (001 SSHA)	■	■	■				■
	Crystal Transmission HFT (001 TRAN)	■	■	■				■
	Crystal Volcano A HF (001 VOL)	■	■	■				■
Metallic Effects								
	Crystal Dorado A HF (001 DOR)	■	■	■				■
	Crystal Light Chrome A HF (001 LTCH)	■	■	■				■
	Crystal Metallic Blue A HF (001 METBL)	■	■	■				■
	Crystal Metallic Light Gold A HF (001 MLGLD)	■	■	■				■
	Crystal Metallic Sunshine A HF (001 METSH)	■	■	■				■
	Crystal Rainbow Dark A HF (001 RABDK)	■	■	■				■
	Crystal Rose Gold A HF (001 ROGL)	■	■	■				■
	Crystal Scarabaeus Green A HF (001 SCGR)	■	■	■				■
Crystal Lacquer ^{Pro}								
	Crystal Army Green DeLite HFT (001 L130D)		■					■
	Crystal Azure Blue HFT (001 L112S)		■					■
	Crystal Burgundy DeLite HFT (001 L132D)		■					■
	Crystal Buttercup HFT (001 L124S)		■					■
	Crystal Cappuccino DeLite HFT (001 L133D)		■					■
	Crystal Dark Grey HFT (001 L111S)		■					■
	Crystal Dark Red HFT (001 L108S)		■					■
	Crystal Elect. Blue DeLite HFT (001 L134D)		■	■				■
	Crystal Elect. Green DeLite HFT (001 L135D)		■	■				■
	Crystal Elect. Orange DeLite HFT (001 L136D)		■	■				■
	Crystal Elect. Pink DeLite HFT (001 L137D)		■	■				■
	Crystal Elect. Violet DeLite HFT (001 L148D)		■	■				■
	Crystal Elect. White DeLite HFT (001 L139D)		■	■				■
	Crystal Elect. Yellow DeLite HFT (001 L138D)		■	■				■

2078

	SS 12	SS 16	SS 20	SS 30	SS 34	SS 40	SS 48
Crystal Electric Blue HFT (001 L134S)		■	■		■		
Crystal Electric Green HFT (001 L135S)		■	■		■		
Crystal Electric Orange HFT (001 L136S)		■	■		■		
Crystal Electric Pink HFT (001 L137S)		■	■		■		
Crystal Electric Violet HFT (001 L148S)		■	■		■		
Crystal Electric White HFT (001 L139S)		■	■		■		
Crystal Electric Yellow HFT (001 L138S)		■	■		■		
Crystal Ivory Cream HFT (001 L106S)		■			■		
Crystal Laguna DeLite HFT (001 L142D)		■			■		
Crystal Lavender DeLite HFT (001 L144D)		■			■		
Crystal Light Coral HFT (001 L116S)		■			■		
Crystal Light Grey DeLite HFT (001 L129D)		■			■		
Crystal Lilac HFT (001 L126S)		■			■		
Crystal Lime HFT (001 L125S)		■			■		
Crystal Lotus Pink DeLite HFT (001 L145D)		■			■		
Crystal Mint Green HFT (001 L115S)		■			■		
Crystal Ocean DeLite HFT (001 L143D)		■			■		
Crystal Ochre DeLite HFT (001 L131D)		■			■		
Crystal Orange Glow DeLite HFT (001 L146D)		■			■		
Crystal Peach DeLite HFT (001 L140D)		■			■		
Crystal Peony Pink HFT (001 L113S)		■			■		
Crystal Royal Blue HFT (001 L110S)		■			■		
Crystal Royal Blue DeLite HFT (001 L110D)		■			■		
Crystal Royal Green HFT (001 L109S)		■			■		
Crystal Royal Red HFT (001 L107S)		■			■		
Crystal Royal Red DeLite HFT (001 L107D)		■			■		
Crystal Silky Sage DeLite HFT (001 L147D)		■			■		
Crystal Summer Blue HFT (001 L114S)		■			■		
Crystal Sunshine DeLite HFT (001 L141D)		■			■		
Color Effects							
Black Diamond Shimmer A HF (215 SHIM)		■	■		■		
Blue Zircon Satin A HF (229 SATIN)	■	■	■		■		
Blue Zircon Shimmer A HF (229 SHIM)		■	■		■		
Citrine Shimmer A HF (249 SHIM)		■	■		■		
Cobalt Shimmer A HF (369 SHIM)		■	■		■		

2078

	SS 12	SS 16	SS 20	SS 30	SS 34	SS 40	SS 48
Erinite Shimmer A HF (360 SHIM)		■	■		■		
Fuchsia Shimmer A HF (502 SHIM)		■	■		■		
Hyacinth Shimmer A HF (236 SHIM)		■	■		■		
Jet AB A HF (280 AB)	■	■	■		■		
Jonquil AB A HF (213 AB)	■	■	■		■		
Light Colorado Topaz Shimmer A HF (246 SH)		■	■		■		
Light Rose AB A HF (223 AB)	■	■	■		■		
Light Rose Shimmer A HF (223 SHIM)		■	■		■		
Light Sapphire Shimmer A HF (211 SHIM)		■	■		■		
Light Siam AB A HF (227 AB)	■	■	■		■		
Light Siam Shimmer A HF (227 SHIM)		■	■		■		
Light Topaz Shimmer A HF (226 SHIM)		■	■		■		
Peridot Shimmer A HF (214 SHIM)		■	■		■		
Rose Peach Shimmer A HF (262 SHIM)		■	■		■		
Sapphire AB A HF (206 AB)	■	■	■		■		
Sapphire Satin A HF (206 SATIN)	■	■	■		■		
Siam Shimmer A HF (208 SHIM)		■	■		■		
Silk Shimmer A HF (391 SHIM)		■	■		■		
Tangerine Shimmer A HF (259 SHIM)		■	■		■		
Tanzanite Shimmer A HF (539 SHIM)		■	■		■		
Topaz Shimmer A HF (203 SHIM)		■	■		■		
Jet Hematite A HF (280 HEM)	■	■	■	■	■		
Jet Nut A HF (280 NUT)	■	■	■	■	■		

FRAMED FLAT BACKS

2078/H FramedFlatBack¹

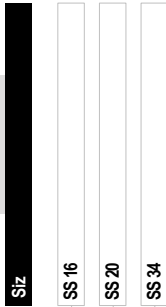

Crystal

Crystal A HF SR (001)	■	■	■
Crystal A HF GR (001)	■	■	■
Crystal A HF PR (001)	■	■	■
Crystal A HF GM (001)	■	■	■

Colors

Plain Colors

Black Diamond A HF GR (215)	■	■	■
Black Diamond A HF PR (215)	■	■	■
Black Diamond A HF GM (215)	■	■	■
Black Diamond A HF SR (215)	■	■	■
Denim Blue A HF SR (266)	■	■	■
Denim Blue A HF PR (266)	■	■	■
Denim Blue A HF GR (266)	■	■	■
Denim Blue A HF GM (266)	■	■	■
Jet A HF PR (280)	■	■	■
Jet A HF GR (280)	■	■	■
Jet A HF SR (280)	■	■	■
Jet A HF GM (280)	■	■	■
Light Colorado Topaz A HF GM (246)	■	■	■
Light Colorado Topaz A HF SR (246)	■	■	■
Light Colorado Topaz A HF PR (246)	■	■	■
Light Colorado Topaz A HF GR (246)	■	■	■
Light Rose A HF SR (223)	■	■	■
Light Rose A HF GR (223)	■	■	■
Light Rose A HF PR (223)	■	■	■
Light Rose A HF GM (223)	■	■	■
Light Siam A HF GM (227)	■	■	■
Light Siam A HF PR (227)	■	■	■
Light Siam A HF GR (227)	■	■	■
Light Siam A HF SR (227)	■	■	■
Silk A HF SR (391)	■	■	■
Silk A HF GR (391)	■	■	■
Silk A HF GM (391)	■	■	■
Silk A HF PR (391)	■	■	■

2078/H FramedFlatBack¹

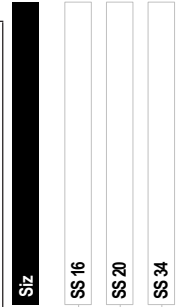

Crystal Effects

Transparent Effects

Crystal AB A HF GM (001 AB)	■	■	■
Crystal AB A HF GR (001 AB)	■	■	■
Crystal AB A HF SR (001 AB)	■	■	■
Crystal AB A HF PR (001 AB)	■	■	■
Crystal Golden Shadow A HF GM (001 GSHA)	■	■	■
Crystal Golden Shadow A HF PR (001 GSHA)	■	■	■
Crystal Golden Shadow A HF GR (001 GSHA)	■	■	■
Crystal Golden Shadow A HF SR (001 GSHA)	■	■	■
Crystal Silver Night A HF GM (001 SINI)	■	■	■
Crystal Silver Night A HF SR (001 SINI)	■	■	■
Crystal Silver Night A HF GR (001 SINI)	■	■	■
Crystal Silver Night A HF PR (001 SINI)	■	■	■
Crystal Silver Shade A HF GM (001 SSHA)	■	■	■
Crystal Silver Shade A HF GR (001 SSHA)	■	■	■
Crystal Silver Shade A HF PR (001 SSHA)	■	■	■
Crystal Silver Shade A HF SR (001 SSHA)	■	■	■

Metallic Effects

Crystal Light Chrome A HF SR (001 LTCH)	■	■	■
Crystal Light Chrome A HF GM (001 LTCH)	■	■	■
Crystal Light Chrome A HF PR (001 LTCH)	■	■	■
Crystal Light Chrome A HF GR (001 LTCH)	■	■	■
Crystal Scarabaeus Green A HF PR (001 SCG)	■	■	■
Crystal Scarabaeus Green A HF GM (001 SC)	■	■	■
Crystal Scarabaeus Green A HF SR (001 SCG)	■	■	■
Crystal Scarabaeus Green A HF GR (001 SC)	■	■	■

Color Effects

Jet Hematite A HF PR (280 HEM)	■	■	■
Jet Hematite A HF GR (280 HEM)	■	■	■
Jet Hematite A HF SR (280 HEM)	■	■	■
Jet Hematite A HF GM (280 HEM)	■	■	■

FRAMED FLAT BACKS

P-4 18-419

*** designed by Jean Paul Gaultier

¹ General lead time: approx. 3 weeks.

The lead time for sampling quantities of up to 2 packing units is approx. 3 weeks.

For special or rush orders, please get in touch with your customer service representative.

RIMMED FLAT BACK

2078/I RimmedFlatBack

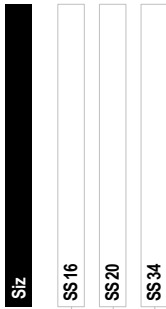
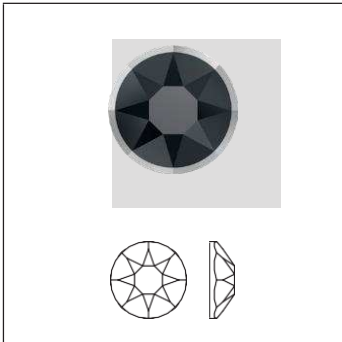

Crystal Effects

Metallic Effects

Crystal Dorado Z A HF (001 DORZ) [Red square] [Red square] [Red square]

Crystal Light Chrome Z A HF (001 LTCHZ) [Red square] [Red square] [Red square]

Color Effects

Black Diamond Dorado Z A HF (215 DORZ) [Red square] [Red square] [Red square]

Black Diamond Light Chrome Z A HF (215 LTCHZ) [Black square] [Black square] [Red square]

Burgundy Dorado Z A HF (515 DORZ) [Red square] [Red square] [Red square]

Burgundy Light Chrome Z A HF (515 LTCHZ) [Red square] [Red square] [Red square]

Denim Blue Dorado Z A HF (266 DORZ) [Red square] [Red square] [Red square]

Denim Blue Light Chrome Z A HF (266 LTCHZ) [Red square] [Red square] [Red square]

Greige Dorado Z A HF (284 DORZ) [Red square] [Red square] [Red square]

Greige Light Chrome Z A HF (284 LTCHZ) [Red square] [Red square] [Red square]

Jet Dorado Z A HF (280 DORZ) [Red square] [Red square] [Red square]

Jet Light Chrome Z A HF (280 LTCHZ) [Black square] [Black square] [Red square]

Khaki Dorado Z A HF (550 DORZ) [Red square] [Red square] [Red square]

Khaki Light Chrome Z A HF (550 LTCHZ) [Red square] [Red square] [Red square]

Light Siam Dorado Z A HF (227 DORZ) [Red square] [Red square] [Red square]

Light Siam Light Chrome Z A HF (227 LTCHZ) [Black square] [Black square] [Red square]

White Opal Dorado Z A HF (234 DORZ) [Red square] [Red square] [Red square]

White Opal Light Chrome Z A HF (234 LTCHZ) [Red square] [Red square] [Red square]

2080/H Framed Cabochon

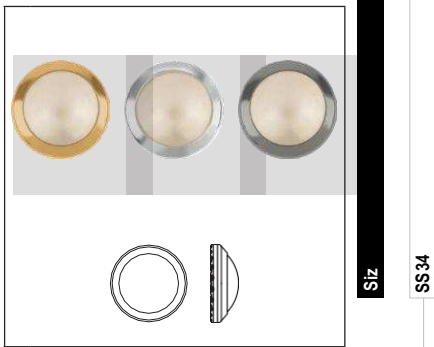

Siz

SS34

Crystal

- Crystal Creampearl HF SR (001 CMPRL) ■
- Crystal Creampearl HF GR (001 CMPRL) ■
- Crystal Creampearl HF PR (001 CMPRL) ■
- Crystal Creampearl HF GM (001 CMPRL) ■

Colors

Plain Colors

- Jet M HF GR (280) ■
- Jet M HF GM (280) ■
- Jet M HF PR (280) ■
- Jet M HF SR (280) ■

Crystal Effects

Transparent Effects

- Crystal Golden Shadow HF SR (001 GSHA) ■
- Crystal Golden Shadow HF GM (001 GSHA) ■
- Crystal Golden Shadow HF PR (001 GSHA) ■
- Crystal Golden Shadow HF GR (001 GSHA) ■
- Crystal Nacre HF GM (001 NACRE) ■
- Crystal Nacre HF SR (001 NACRE) ■
- Crystal Nacre HF GR (001 NACRE) ■
- Crystal Nacre HF PR (001 NACRE) ■
- Crystal White Pearl HF PR (001 650) ■
- Crystal White Pearl HF SR (001 650) ■
- Crystal White Pearl HF GM (001 650) ■
- Crystal White Pearl HF GR (001 650) ■

Color Effects

Metallic Effects

- Jet Hematite M HF GR (280 HEM) ■
- Jet Hematite M HF SR (280 HEM) ■
- Jet Hematite M HF PR (280 HEM) ■
- Jet Hematite M HF GM (280 HEM) ■

RIMMED FLAT BACK S

CABOCHONS

2080/4 Cabochon



	SS10	SS16	SS34
Crystal			
Crystal Creampearl HF (001 CMPRL)	■	■	■
Colors			
Plain Colors			
● Jet M HF (280)	■	■	■
Crystal Effects			
Transparent Effects			
● Crystal Golden Shadow HF (001 GSHA)	■	■	■
Metallic Effects			
Crystal Light Chrome HF (001 LTCH)	■	■	■
Crystal Scarabaeus Green HF (001 SCGR)	■	■	■
Crystal Bronze Pearl HF (001 295)	■		
Crystal Dark Grey Pearl HF (001 617)	■	■	■
⊕ Crystal Iridesc. Dv Grey PRL HF (001 954)	■	■	■
● Crystal Light Grey Pearl HF (001 616)	■	■	
Crystal Nacre HF (001 NACRE)	■	■	■
Crystal Rosaline Pearl HF (001 294)	■	■	■
Crystal Rose Gold Pearl HF (001 769)	■	■	■
Crystal Vintage Gold Pearl HF (001 651)	■	■	■
Crystal White Pearl HF (001 650)	■	■	■
Color Effects			
⊕ Jet Hematite M HF (280 HEM)	■	■	■

2081/2 Cabochon Pearl

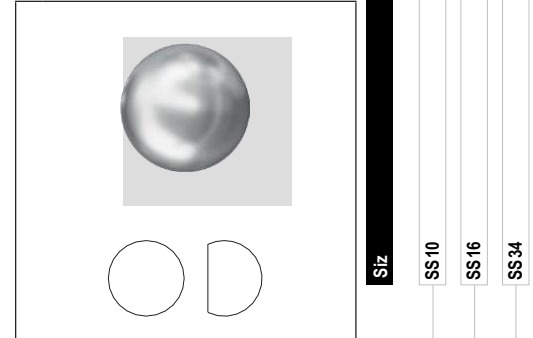

	SS10	SS16	SS34
Crystal			
Crystal Creampearl W_PRHF (001 CMPRL)	■	■	■
Colors			
Plain Colors			
● Jet G PRHF (280)	■	■	■
Crystal Effects			
Metallic Effects			
Crystal Light Chrome G_PRHF (001 LTCH)	■	■	■
⊕ Crystal Iridesc. Dv Grey PRL W PRHF (001 9	■	■	■
Crystal Nacre W_PRHF (001 NACRE)	■	■	■
Crystal Rose Gold Pearl W_PRHF (001 769)	■	■	■
Crystal Vintage Gold Pearl W_PRHF (001 65	■	■	■
Crystal White Pearl W_PRHF (001 650)	■	■	■
Color Effects			
⊕ Jet Hematite G_PRHF (280 HEM)	■	■	■

2208/4 Cabochon Navette

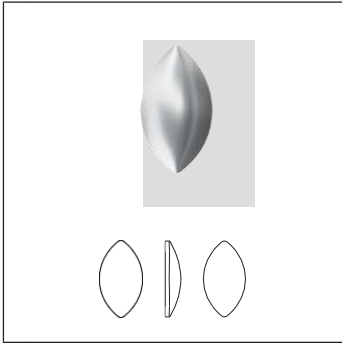

Siz	MM 6,0X 3,5	MM 8,0X 4,5	MM 10,0X 5,5
-----	-------------	-------------	--------------

Crystal			
Crystal Creampearl W_PRHF (001 CMPRL)	■	■	■
Colors			
Plain Colors			
● Jet G_PRHF (280)	■	■	■
Crystal Nacre W_PRHF (001 NACRE)	■	■	■
Crystal White Pearl W_PRHF (001 650)	■	■	■
Color Effects			
Metallic Effects			
● Jet Hematite G_PRHF (280 HEM)	■	■	■

2308/4 Cabochon Drop

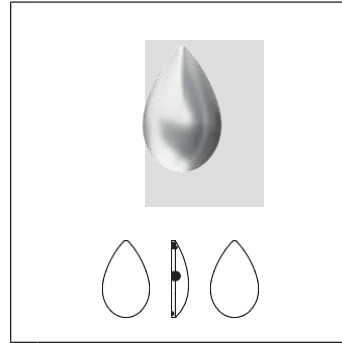

Siz	MM 6,0X 3,5	MM 8,0X 5,0	MM 10,0X 6,0
-----	-------------	-------------	--------------

Crystal			
Crystal Creampearl W_PRHF (001 CMPRL)	■	■	■
Colors			
Plain Colors			
● Jet G_PRHF (280)	■	■	■
Crystal Nacre W_PRHF (001 NACRE)	■	■	■
Crystal White Pearl W_PRHF (001 650)	■	■	■
Color Effects			
Metallic Effects			
● Jet Hematite G_PRHF (280 HEM)	■	■	■

2408/4 Cabochon Square

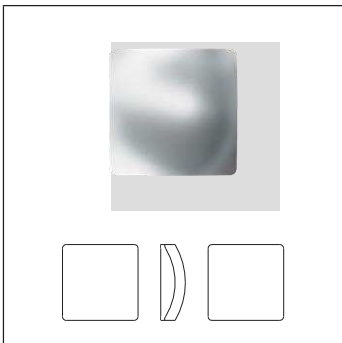

Siz	MM 4,0	MM 6,0	MM 8,0
-----	--------	--------	--------

Crystal			
Crystal Creampearl W_PRHF (001 CMPRL)	■	■	■
Colors			
Plain Colors			
● Jet G_PRHF (280)	■	■	■
Crystal Nacre W_PRHF (001 NACRE)	■	■	■
Crystal White Pearl W_PRHF (001 650)	■	■	■
Color Effects			
Metallic Effects			
● Jet Hematite G_PRHF (280 HEM)	■	■	■

CORE ASSORTMENT

2200 Navette Flat Back

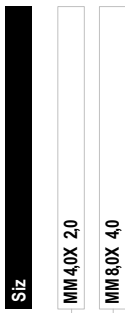
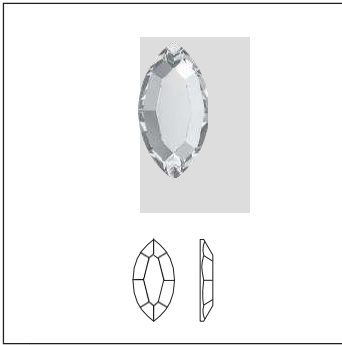

Crystal

Crystal M HF (001)

Colors

Plain Colors

Amethyst M HF (204)

Aquamarine M HF (202)

Emerald M HF (205)

Jet M HF (280)

Light Colorado Topaz M HF (246)

Light Rose M HF (223)

Scarlet M HF (276)

Crystal Effects

Transparent Effects

Crystal AB M HF (001 AB)

Crystal Golden Shadow M HF (001 GSHA)

Crystal Silver Shade M HF (001 SSHA)

Color Effects

Metallic Effects

Jet Hematite M HF (280 HEM)

2200/1 Rimmed Navette Flat Back

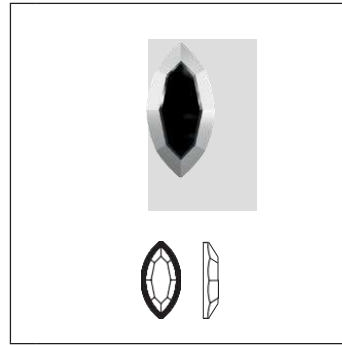

Crystal Effects

Metallic Effects

Crystal Dorado Z M HF (001 DORZ)

Crystal Light Chrome Z M HF (001 LTCHZ)

Color Effects

Jet Dorado Z M HF (280 DORZ)

Jet Light Chrome Z M HF (280 LTCHZ)

2201 Marquise Flat Back

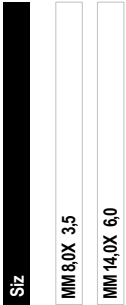
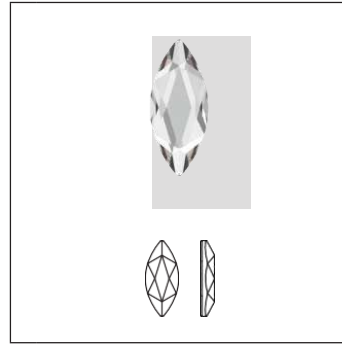

Crystal

Crystal M HF (001)

Colors

Plain Colors

Aquamarine M HF (202)

Emerald M HF (205)

Graphite M HF (253)

Jet M HF (280)

Sapphire M HF (206)

Scarlet M HF (276)

Sunflower M HF (292)

Vintage Rose M HF (319)

Crystal Effects

Transparent Effects

Crystal AB M HF (001 AB)

Crystal Golden Shadow M HF (001 GSHA)

Crystal Silver Shade M HF (001 SSHA)

2205 Flame Flat Back



Siz	MM 7,5	MM 10,0	MM 14,0
-----	--------	---------	---------

- Crystal**
- Crystal M HF (001)
- Colors**
- Plain Colors**
- Fireopal M HF (237)
- Jet M HF (280)
- Light Colorado Topaz M HF (246)
- Light Siam M HF (227)
- Opal Colors**
- White Opal M HF (234)
- Crystal Effects**
- Transparent Effects**
- Crystal AB M HF (001 AB)
- Crystal Golden Shadow M HF (001 GSHA)
- Crystal Silver Night M HF (001 SINI)
- Metallic Effects**
- Crystal Iridescent Green M HF (001 IRIG)

CORE ASSORTMENT

2300 Drop Flat Back



Siz	MM 8,0X 4,8
-----	-------------

- Crystal**
- Crystal M HF (001)
- Colors**
- Plain Colors**
- Amethyst M HF (204)
- Aquamarine M HF (202)
- Emerald M HF (205)
- Jet M HF (280)
- Light Colorado Topaz M HF (246)
- Light Rose M HF (223)
- Scarlet M HF (276)
- Crystal Effects**
- Transparent Effects**
- Crystal AB M HF (001 AB)
- Crystal Golden Shadow M HF (001 GSHA)
- Color Effects**
- Metallic Effects**
- Jet Hematite M HF (280 HEM)

2300/I RhmedDropFlat Back

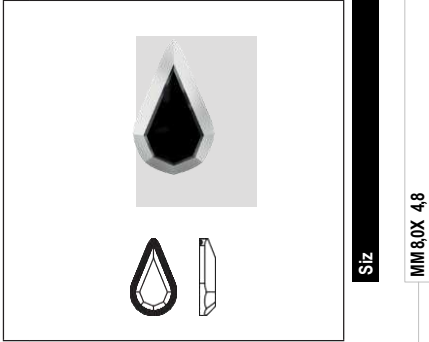

Siz

MM 8,0X 4,8

Crystal Effects

Metallic Effects

Crystal Dorado Z M HF (001 DORZ)

Crystal Light Chrome Z M HF (001 LTCHZ)

Color Effects

Jet Dorado Z M HF (280 DORZ)

Jet Light Chrome Z M HF (280 LTCHZ)

2304 RaindropFlat Back

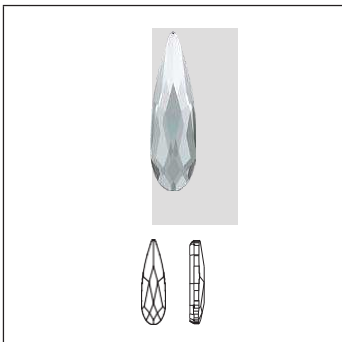

Siz

MM 10,0X 2,8

Crystal

Crystal M HF (001)

Colors

Plain Colors

Jet M HF (280)

Light Siam M HF (227)

Crystal Effects

Transparent Effects

Crystal AB M HF (001 AB)

Crystal Golden Shadow M HF (001 GSHA)

Crystal Luminous Green M HF (001 LUMG)

Crystal Silver Night M HF (001 SINI)

2303 PearFlatBack

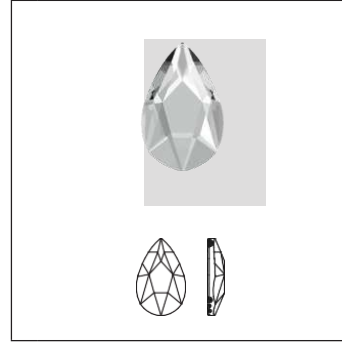

Siz

MM 8,0X 5,0

MM 14,0X 9,0

Crystal

Crystal M HF (001)

Colors

Plain Colors

Aquamarine M HF (202)

Emerald M HF (205)

Graphite M HF (253)

Jet M HF (280)

Sapphire M HF (206)

Scarlet M HF (276)

Sunflower M HF (292)

Vintage Rose M HF (319)

Crystal Effects

Transparent Effects

Crystal AB M HF (001 AB)

Crystal Golden Shadow M HF (001 GSHA)

Crystal Silver Shade M HF (001 SSHA)

2364 PASLEYXFLATBACK



Siz	MM 6,0X 3,7	MM 10,0X 6,0	MM 14,0X 8,5
-----	-------------	--------------	--------------

Crystal			
<input type="checkbox"/>	Crystal M HF (001)	<input checked="" type="checkbox"/>	<input checked="" type="checkbox"/>
Colors			
Plain Colors			
<input checked="" type="checkbox"/>	Jet M HF (280)	<input type="checkbox"/>	<input type="checkbox"/>
<input checked="" type="checkbox"/>	Light Colorado Topaz M HF (246)	<input type="checkbox"/>	<input type="checkbox"/>
<input checked="" type="checkbox"/>	Majestic Blue M HF (296)	<input checked="" type="checkbox"/>	<input checked="" type="checkbox"/>
<input checked="" type="checkbox"/>	Scarlet M HF (276)	<input checked="" type="checkbox"/>	<input checked="" type="checkbox"/>
Crystal Effects			
Transparent Effects			
<input checked="" type="checkbox"/>	Crystal AB M HF (001 AB)	<input checked="" type="checkbox"/>	<input type="checkbox"/>
<input checked="" type="checkbox"/>	Crystal Golden Shadow M HF (001 GSHA)	<input checked="" type="checkbox"/>	<input type="checkbox"/>
<input checked="" type="checkbox"/>	Crystal Silver Night M HF (001 SINI)	<input checked="" type="checkbox"/>	<input checked="" type="checkbox"/>
<input checked="" type="checkbox"/>	Crystal Silver Shade M HF (001 SSHA)	<input checked="" type="checkbox"/>	<input type="checkbox"/>

2365 PASLEY YFLATBACK



Siz	MM 6,0X 3,7	MM 10,0X 6,0	MM 14,0X 8,5
-----	-------------	--------------	--------------

Crystal			
<input type="checkbox"/>	Crystal M HF (001)	<input checked="" type="checkbox"/>	<input checked="" type="checkbox"/>
Colors			
Plain Colors			
<input checked="" type="checkbox"/>	Jet M HF (280)	<input type="checkbox"/>	<input type="checkbox"/>
<input checked="" type="checkbox"/>	Light Colorado Topaz M HF (246)	<input type="checkbox"/>	<input type="checkbox"/>
<input checked="" type="checkbox"/>	Majestic Blue M HF (296)	<input checked="" type="checkbox"/>	<input checked="" type="checkbox"/>
<input checked="" type="checkbox"/>	Scarlet M HF (276)	<input checked="" type="checkbox"/>	<input checked="" type="checkbox"/>
Crystal Effects			
Transparent Effects			
<input checked="" type="checkbox"/>	Crystal AB M HF (001 AB)	<input checked="" type="checkbox"/>	<input type="checkbox"/>
<input checked="" type="checkbox"/>	Crystal Golden Shadow M HF (001 GSHA)	<input checked="" type="checkbox"/>	<input type="checkbox"/>
<input checked="" type="checkbox"/>	Crystal Silver Night M HF (001 SINI)	<input checked="" type="checkbox"/>	<input checked="" type="checkbox"/>
<input checked="" type="checkbox"/>	Crystal Silver Shade M HF (001 SSHA)	<input checked="" type="checkbox"/>	<input type="checkbox"/>

SQUARE FAMILY

CORE ASSORTMENT

2400 Square Flat Back

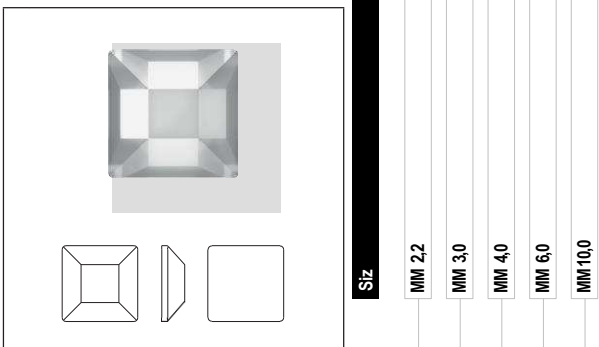

Siz	MM 2,2	MM 3,0	MM 4,0	MM 6,0	MM 10,0
-----	--------	--------	--------	--------	---------

Crystal	MM 2,2	MM 3,0	MM 4,0	MM 6,0	MM 10,0
Crystal M HF (001)	■	■	■	■	■
Colors					
Plain Colors					
Amethyst M HF (204)	■	■	■		
Aquamarine M HF (202)	■	■	■		
Emerald M HF (205)		■	■		
Jet M HF (280)	■	■	■	■	■
Light Colorado Topaz M HF (246)	■	■	■		
Light Rose M HF (223)		■	■		
Scarlet M HF (276)		■	■		
Crystal Effects					
Transparent Effects					
Crystal AB M HF (001 AB)	■	■	■	■	
Crystal Golden Shadow M HF (001 GSHA)	■	■	■	■	
Crystal Silver Night M HF (001 SINI)		■	■	■	
Metallic Effects					
Crystal Dorado M HF (001 DOR)			■	■	
Crystal Light Chrome M HF (001 LTCH)		■	■	■	
Color Effects					
Jet Hematite M HF (280 HEM)		■	■	■	

2402 Base Flat Back

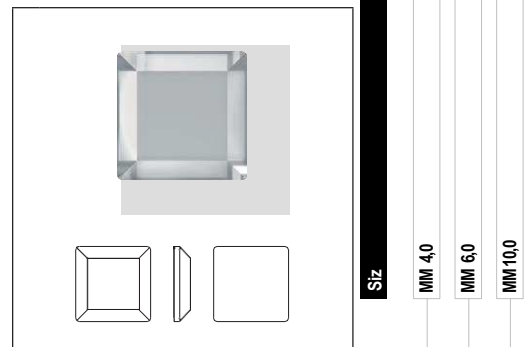

Siz	MM 4,0	MM 6,0	MM 10,0
-----	--------	--------	---------

Crystal	MM 4,0	MM 6,0	MM 10,0
Crystal M HF (001)	■	■	■
Colors			
Plain Colors			
Jet M HF (280)	■	■	■
Crystal Effects			
Transparent Effects			
Crystal AB M HF (001 AB)	■	■	
Crystal Golden Shadow M HF (001 GSHA)	■	■	
Crystal Silver Night M HF (001 SINI)	■	■	
Metallic Effects			
Crystal Dorado M HF (001 DOR)	■	■	
Crystal Light Chrome M HF (001 LTCH)	■	■	
Color Effects			
Jet Hematite M HF (280 HEM)	■	■	

SQUARE FAMILY

2403 Pyramid FlatBack

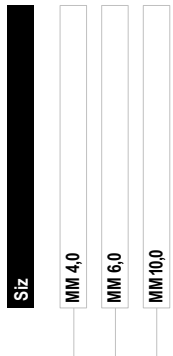
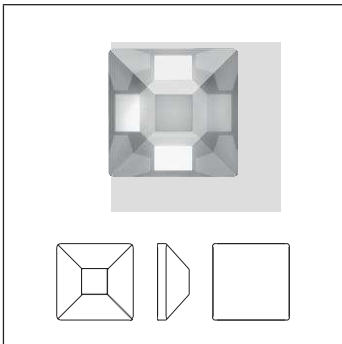

	MM 4,0	MM 6,0	MM 10,0
Crystal			
Crystal M HF (001)	■	■	■
Colors			
Plain Colors			
Jet M HF (280)	■	■	■
Crystal Effects			
Transparent Effects			
Crystal AB M HF (001 AB)	■	■	
Crystal Golden Shadow M HF (001 GSHA)	■	■	
Crystal Silver Night M HF (001 SINI)	■	■	
Metallic Effects			
Crystal Dorado M HF (001 DOR)	■	■	
Crystal Light Chrome M HF (001 LTCH)	■	■	
Color Effects			
Jet Hematite M HF (280 HEM)	■	■	

2419 SQUARE SPIKE FLAT BACK



Siz	MM 4,0X 4,0	MM 5,0X 5,0	MM 6,0X 6,0
-----	-------------	-------------	-------------

Crystal	MM 4,0X 4,0	MM 5,0X 5,0	MM 6,0X 6,0
Crystal M HF (001)	■	■	■
Crystal Effects			
Transparent Effects			
Crystal AB M HF (001 AB)	■	■	■
Crystal Blue Shade M HF (001 BLSH)	■	■	■
Crystal Golden Shadow M HF (001 GSHA)	■	■	■
Crystal Volcano M HF (001 VOL)	■	■	■
Color Effects			
Black Diamond Shimmer M HF (215 SHIM)	■	■	■
Light Topaz Shimmer M HF (226 SHIM)	■	■	■

2471 CUSHION FLAT BACK



Siz	MM 5,0	MM 7,0	MM 10,0
-----	--------	--------	---------

Crystal	MM 5,0	MM 7,0	MM 10,0
Crystal M HF (001)	■	■	■
Colors			
Plain Colors			
Aquamarine M HF (202)	■	■	■
Emerald M HF (205)	■	■	■
Graphite M HF (253)	■	■	■
Jet M HF (280)	■	■	■
Sapphire M HF (206)	■	■	■
Scarlet M HF (276)	■	■	■
Sunflower M HF (292)	■	■	■
Vintage Rose M HF (319)	■	■	■
Crystal Effects			
Transparent Effects			
Crystal AB M HF (001 AB)	■	■	■
Crystal Golden Shadow M HF (001 GSHA)	■	■	■
Crystal Silver Shade M HF (001 SSHA)	■	■	■

2493 Chessboard Flat Back

Siz

MM 8,0
MM 10,0
MM 12,0

Crystal

Crystal M HF (001)

Crystal Effects

Transparent Effects

Crystal AB M HF (001 AB)

2494 Starlet Flat Back

Siz

MM 6,0
MM 8,0
MM 10,5

Crystal

Crystal M HF (001)

Crystal Effects

Transparent Effects

Crystal Golden Shadow M HF (001 GSHA)

Crystal Paradise Shine M HF (001 PARSH)

2510 Baguette Flat Back

Siz

MM 3,7X 1,9
MM 5,0X 2,5

Crystal

Crystal M HF (001)

Colors

Plain Colors

Jet M HF (280)

Crystal Effects

Transparent Effects

Crystal AB M HF (001 AB)

Crystal Golden Shadow M HF (001 GSHA)

Color Effects

Metallic Effects

Jet Hematite M HF (280 HEM)

2555 Cosmic Baguette Flat Back

Siz

MM 8,0X 2,6
MM 12,0X 4,0
MM 15,0X 5,0

Crystal

Crystal M HF (001)

Crystal Effects

Transparent Effects

Crystal AB M HF (001 AB)

Crystal Golden Shadow M HF (001 GSHA)

Crystal Silver Shade M HF (001 SSHA)

2602 Emerald Cut Flat Back

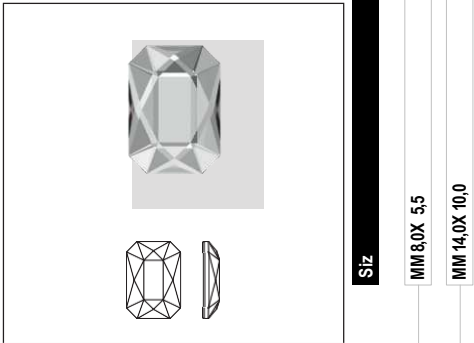

Siz

MM 8,0X 5,5

MM 14,0X 10,0

Crystal

Crystal M HF (001)

Colors

Plain Colors

Aquamarine M HF (202)

Emerald M HF (205)

Graphite M HF (253)

Jet M HF (280)

Sapphire M HF (206)

Scarlet M HF (276)

Sunflower M HF (292)

Vintage Rose M HF (319)

Crystal Effects

Transparent Effects

Crystal AB M HF (001 AB)

Crystal Golden Shadow M HF (001 GSHA)

Crystal Silver Shade M HF (001 SSHA)

2610 Rectangle Flat Back



Siz

MM 6,0X 4,0

Crystal

Crystal M HF (001)

2709 Rhombus Flat Back

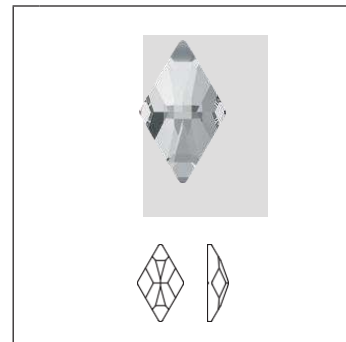

Siz

MM 10,0X 6,0

Crystal

Crystal M HF (001)

Colors

Plain Colors

Light Siam M HF (227)

Crystal Effects

Transparent Effects

Crystal AB M HF (001 AB)

Crystal Golden Shadow M HF (001 GSHA)

2711 Triangle Flat Back

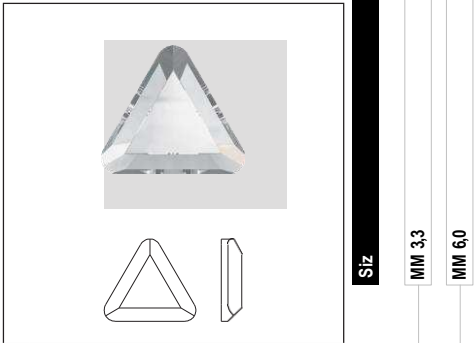

Siz
MM 3,3
MM 6,0

- Crystal**
- Crystal M HF (001)
- Colors**
- Plain Colors**
- Amethyst M HF (204)
- Aquamarine M HF (202)
- Emerald M HF (205)
- Jet M HF (280)
- Light Colorado Topaz M HF (246)
- Crystal Effects**
- Transparent Effects**
- Crystal AB M HF (001 AB)
- Crystal Golden Shadow M HF (001 GSHA)
- Color Effects**
- Metallic Effects**
- Jet Hematite M HF (280 HEM)

2711/I RhmedTriangle Flat Back

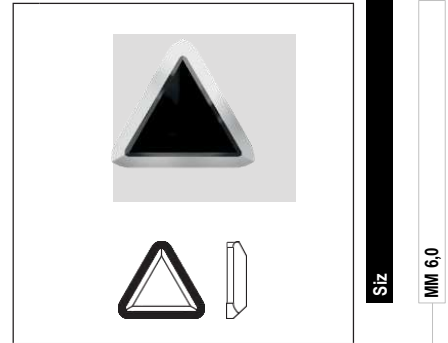

Siz
MM 6,0

- Crystal Effects**
- Metallic Effects**
- Crystal Dorado Z M HF (001 DORZ)
- Crystal Light Chrome Z M HF (001 LTCHZ)
- Color Effects**
- Jet Dorado Z M HF (280 DORZ)
- Jet Light Chrome Z M HF (280 LTCHZ)

2714 Fan Flat Back Hotfix

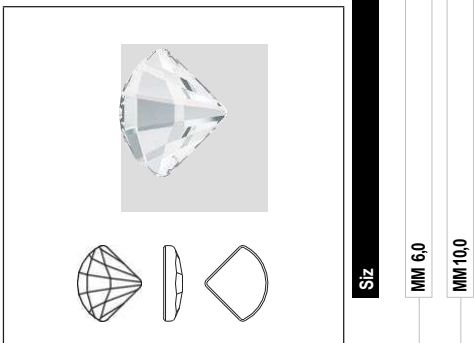

Siz
MM 6,0
MM 10,0

- Crystal**
- Crystal M HF (001)
- Crystal Effects**
- Transparent Effects**
- Crystal AB M HF (001 AB)

2716 Rivoli Triangle Flat Back

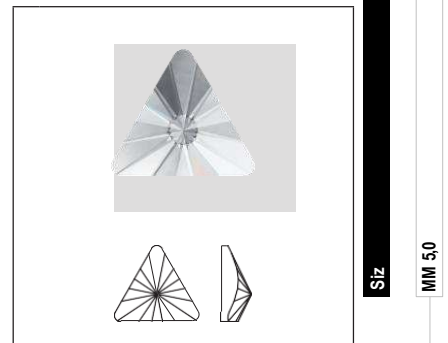

Siz
MM 5,0

- Crystal**
- Crystal M HF (001)
- Crystal Effects**
- Transparent Effects**
- Crystal AB M HF (001 AB)

2728 Marguerite FlatBack

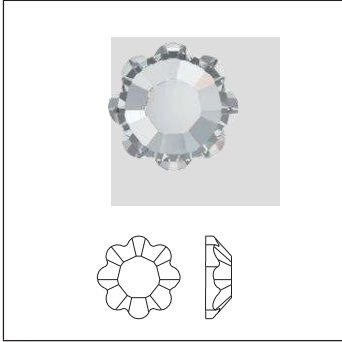

Siz	SS 10	SS 16	SS 20	SS 34
Crystal				
Crystal M HF (001)	■	■	■	■
Crystal Effects				
Transparent Effects				
Crystal AB M HF (001 AB)	■	■	■	■

Crystal

Crystal M HF (001)

Crystal Effects

Transparent Effects

Crystal AB M HF (001 AB)

TRIANGLE FAMILY

2738 Triangle Alpha Flat Back

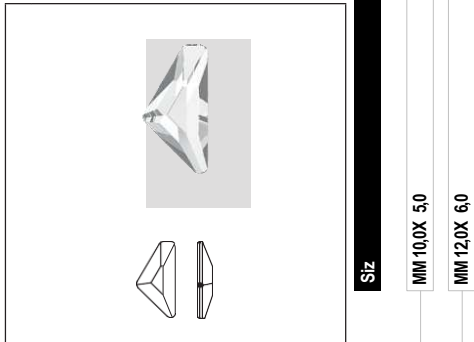

Siz
MM 10,0X 5,0
MM 12,0X 6,0

Crystal

Crystal M HF (001)

Colors

Plain Colors

Blush Rose M HF (257)

Jet M HF (280)

Light Colorado Topaz M HF (246)

Light Sapphire M HF (211)

Light Siam M HF (227)

Crystal Effects

Transparent Effects

Crystal AB M HF (001 AB)

Crystal Golden Shadow M HF (001 GSHA)

Crystal Silver Night M HF (001 SINI)

Crystal Lacquer ^{Pro}

Crystal Dark Grey HFT (001 L111S)

Crystal Dark Red HFT (001 L108S)

Crystal Ivory Cream HFT (001 L106S)

Color Effects

Light Colorado Topaz Shimmer M HF (246 S)

Light Sapphire Shimmer M HF (211 SHIM)

Light Siam Shimmer M HF (227 SHIM)

2739 Triangle Beta Flat Back

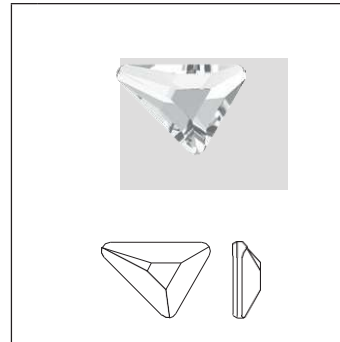

Siz
MM 5,8X 5,3
MM 7,0X 6,5

Crystal

Crystal M HF (001)

Colors

Plain Colors

Blush Rose M HF (257)

Jet M HF (280)

Light Colorado Topaz M HF (246)

Light Sapphire M HF (211)

Light Siam M HF (227)

Crystal Effects

Transparent Effects

Crystal AB M HF (001 AB)

Crystal Golden Shadow M HF (001 GSHA)

Crystal Silver Night M HF (001 SINI)

Crystal Lacquer ^{Pro}

Crystal Dark Grey HFT (001 L111S)

Crystal Dark Red HFT (001 L108S)

Crystal Ivory Cream HFT (001 L106S)

Color Effects

Light Colorado Topaz Shimmer M HF (246 S)

Light Sapphire Shimmer M HF (211 SHIM)

Light Siam Shimmer M HF (227 SHIM)

TRIANGLE FAMILY

2740 Triangle GammaFlat Back

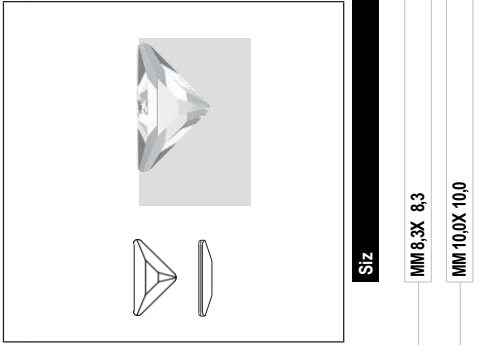

Size
 MM 8,3X 8,3
 MM 10,0X 10,0

Crystal	MM 8,3X 8,3	MM 10,0X 10,0
Crystal M HF (001)	■	■
Colors		
Plain Colors		
Blush Rose M HF (257)	■	■
Jet M HF (280)	■	■
Light Colorado Topaz M HF (246)	■	■
Light Sapphire M HF (211)	■	■
Light Siam M HF (227)	■	■
Crystal Effects		
Transparent Effects		
Crystal AB M HF (001 AB)	■	■
Crystal Golden Shadow M HF (001 GSHA)	■	■
Crystal Silver Night M HF (001 SINI)	■	■
Crystal Lacquer <sup>Pro</sup>		
Crystal Dark Grey HFT (001 L111S)	■	■
Crystal Dark Red HFT (001 L108S)	■	■
Crystal Ivory Cream HFT (001 L106S)	■	■
Color Effects		
Light Colorado Topaz Shimmer M HF (246 S)	■	■
Light Sapphire Shimmer M HF (211 SHIM)	■	■
Light Siam Shimmer M HF (227 SHIM)	■	■

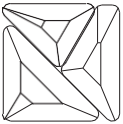

When Alpha, Beta, and GammaFlat Backs are arranged together, they form a square.

2753 Edelweiss Flat Back

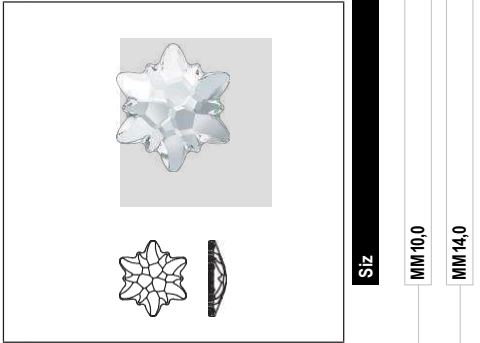

Siz
MM10,0
MM14,0

- Crystal
- Crystal M HF (001)
- Crystal Effects
- Transparent Effects
- Crystal AB M HF (001 AB)

2770 Wing Flat Back

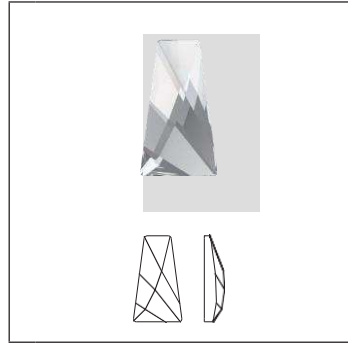

Siz
MM6,0X 3,5

- Crystal
- Crystal M HF (001)
- Crystal Effects
- Transparent Effects
- Crystal AB M HF (001 AB)

GEOMETRIC FLAT BACKS

2771 Kite Flat Back Hotfix

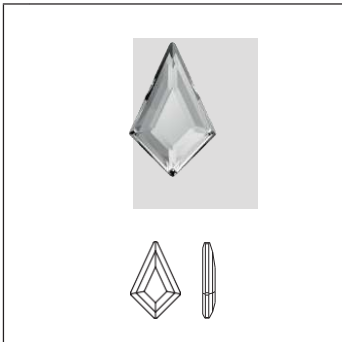

Siz	MM 6,4X 4,2	MM 8,6X 5,6	MM 12,9X 8,3
-----	-------------	-------------	--------------

Crystal	MM 6,4X 4,2	MM 8,6X 5,6	MM 12,9X 8,3
Crystal M HF (001)	■	■	■
Colors			
Plain Colors			
Aquamarine M HF (202)	■	■	■
Black Diamond M HF (215)	■	■	■
Jet M HF (280)	■	■	■
Light Rose M HF (223)	■	■	■
Light Siam M HF (227)	■	■	■
Crystal Effects			
Transparent Effects			
Crystal AB M HF (001 AB)	■	■	■
Crystal Golden Shadow M HF (001 GSHA)	■	■	■
Crystal Silver Shade M HF (001 SSHA)	■	■	■
Color Effects			
Metallic Effects			
Jet Hematite M HF (280 HEM)	■	■	■

2772 Trapeze Flat Back Hotfix

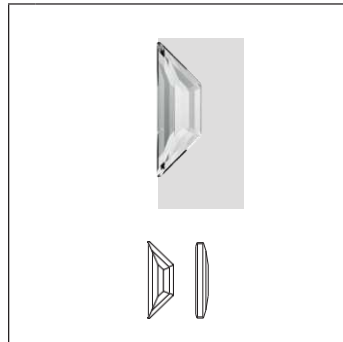

Siz	MM 6,5X 2,1	MM 8,6X 2,8	MM 12,9X 4,2
-----	-------------	-------------	--------------

Crystal	MM 6,5X 2,1	MM 8,6X 2,8	MM 12,9X 4,2
Crystal M HF (001)	■	■	■
Colors			
Plain Colors			
Aquamarine M HF (202)	■	■	■
Black Diamond M HF (215)	■	■	■
Jet M HF (280)	■	■	■
Crystal Effects			
Transparent Effects			
Crystal AB M HF (001 AB)	■	■	■
Crystal Golden Shadow M HF (001 GSHA)	■	■	■
Crystal Silver Shade M HF (001 SSHA)	■	■	■
Color Effects			
Metallic Effects			
Jet Hematite M HF (280 HEM)	■	■	■

2773 Diamond Shape Flat Back Hotfix

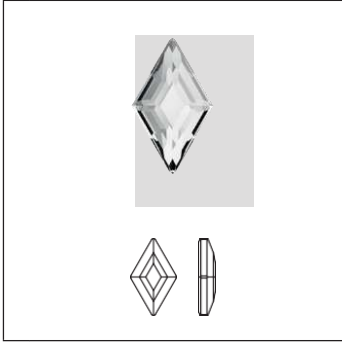

Size	MM 5,0X 3,0	MM 6,6X 3,9	MM 9,9X 5,9
------	-------------	-------------	-------------

Crystal

Crystal M HF (001)	■	■	■
--------------------	---	---	---

Colors

Plain Colors

Aquamarine M HF (202)	■	■	■
-----------------------	---	---	---

Black Diamond M HF (215)	■	■	■
--------------------------	---	---	---

Jet M HF (280)	■	■	■
----------------	---	---	---

Light Rose M HF (223)	■	■	■
-----------------------	---	---	---

Light Siam M HF (227)	■	■	■
-----------------------	---	---	---

Crystal Effects

Transparent Effects

Crystal AB M HF (001 AB)	■	■	■
--------------------------	---	---	---

Crystal Golden Shadow M HF (001 GSHA)	■	■	■
---------------------------------------	---	---	---

Crystal Silver Shade M HF (001 SSHA)	■	■	■
--------------------------------------	---	---	---

Color Effects

Metallic Effects

Jet Hematite M HF (280 HEM)	■	■	■
-----------------------------	---	---	---

GEOMETRIC FLAT BACKS

2774 ELONGATED PENTAGON FB



Siz	MM 6,3X 4,2	MM 8,3X 5,6	MM 12,5X 8,4
-----	-------------	-------------	--------------

- Crystal**
- Crystal M HF (001)
- Colors**
- Plain Colors**
- Black Diamond M HF (215)
- Light Siam M HF (227)
- Crystal Effects**
- Transparent Effects**
- Crystal AB M HF (001 AB)
- Color Effects**
- Metallic Effects**
- Jet Hematite M HF (280 HEM)

2775 CONCISE PENTAGON FB



Siz	MM 5,0X 4,2	MM 6,7X 5,6	MM 10,0X 8,4
-----	-------------	-------------	--------------

- Crystal**
- Crystal M HF (001)
- Colors**
- Plain Colors**
- Black Diamond M HF (215)
- Light Siam M HF (227)
- Crystal Effects**
- Transparent Effects**
- Crystal AB M HF (001 AB)
- Color Effects**
- Metallic Effects**
- Jet Hematite M HF (280 HEM)

2776 ELONGATED HEXAGON FB



Siz	MM 8,2X 4,2	MM 11,0X 5,6	MM 16,5X 8,4
-----	-------------	--------------	--------------

- Crystal**
- Crystal M HF (001)
- Colors**
- Plain Colors**
- Black Diamond M HF (215)
- Light Siam M HF (227)
- Crystal Effects**
- Transparent Effects**
- Crystal AB M HF (001 AB)
- Color Effects**
- Metallic Effects**
- Jet Hematite M HF (280 HEM)

2777 CONCISE HEXAGON FB

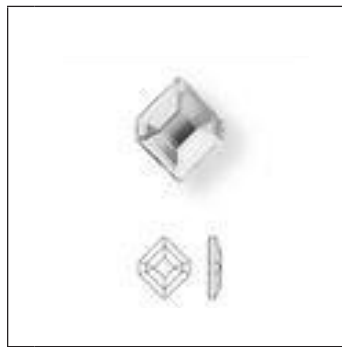

Siz	MM 5,0X 4,2	MM 6,7X 5,6	MM 10,0X 8,4
-----	-------------	-------------	--------------

- Crystal**
- Crystal M HF (001)
- Colors**
- Plain Colors**
- Black Diamond M HF (215)
- Light Siam M HF (227)
- Crystal Effects**
- Transparent Effects**
- Crystal AB M HF (001 AB)
- Color Effects**
- Metallic Effects**
- Jet Hematite M HF (280 HEM)

2788 Wave FlatBack

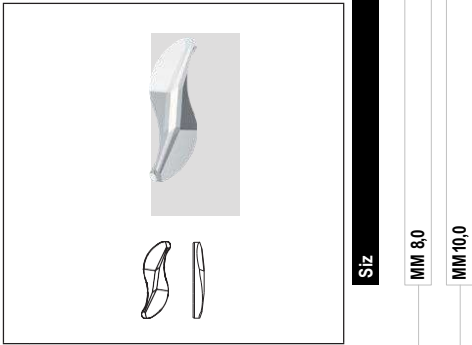

Siz
MM 8,0
MM 10,0

- Crystal
- Crystal M HF (001)
- Crystal Effects
- Transparent Effects
- Crystal AB M HF (001 AB)

2808 Heart Flat Back

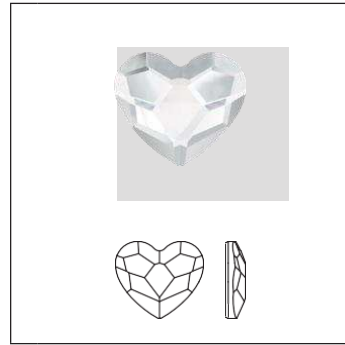

Siz
MM 3,6
MM 6,0
MM 10,0

- Crystal
- Crystal M HF (001)
- Colors
- Plain Colors
- Fuchsia M HF (502)
- Jet M HF (280)
- Light Siam M HF (227)
- Crystal Effects
- Transparent Effects
- Crystal AB M HF (001 AB)
- Crystal Golden Shadow M HF (001 GSHA)
- Crystal Lacquer ^{Pro}
- Crystal Royal Red HFT (001 L107S)

2813 Moon Flat Back Hotfix

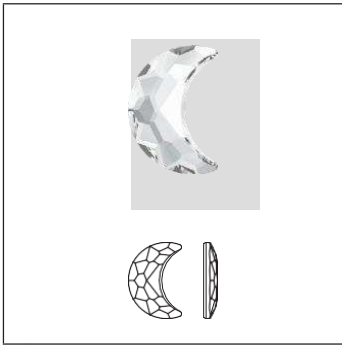

Siz
MM 8,0X 5,5

- Crystal
- Crystal M HF (001)
- Crystal Effects
- Transparent Effects
- Crystal AB M HF (001 AB)

2816 Rivoli Star Flat Back

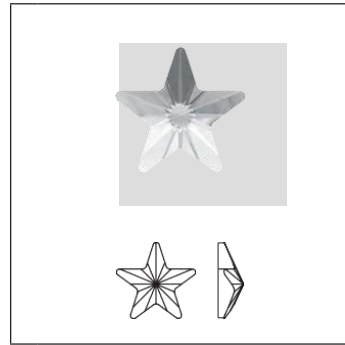

Siz
MM 5,0

- Crystal
- Crystal M HF (001)
- Colors
- Plain Colors
- Jet M HF (280)
- Crystal Effects
- Transparent Effects
- Crystal AB M HF (001 AB)
- Color Effects
- Metallic Effects
- Jet Hematite M HF (280 HEM)

2817 Star Flat Back

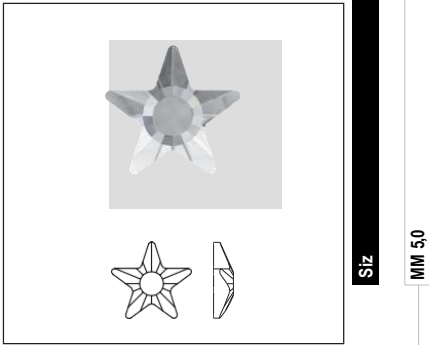

Siz

MM 5,0

- Crystal**
- Crystal M HF (001)
- Crystal Effects**
- Transparent Effects**
- Crystal AB M HF (001 AB)
- Crystal Golden Shadow M HF (001 GSHA)
- Crystal Silver Night M HF (001 SINI)

2826 Rivoli Snowflake Flat Back

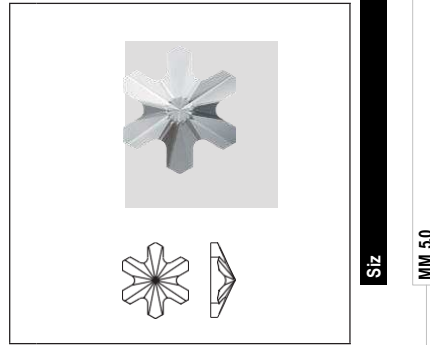

Siz

MM 5,0

- Crystal**
- Crystal M HF (001)
- Crystal Effects**
- Transparent Effects**
- Crystal AB M HF (001 AB)

2855 Butterfly Flat Back

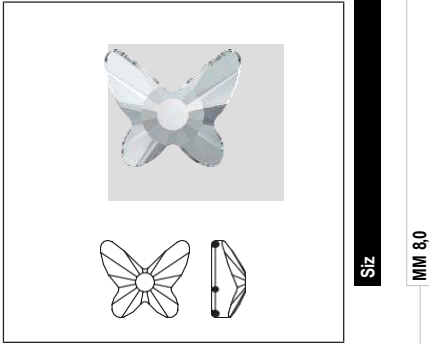

Siz

MM 8,0

- Crystal**
- Crystal M HF (001)
- Crystal Effects**
- Transparent Effects**
- Crystal AB M HF (001 AB)

2856 Skull Flat Back

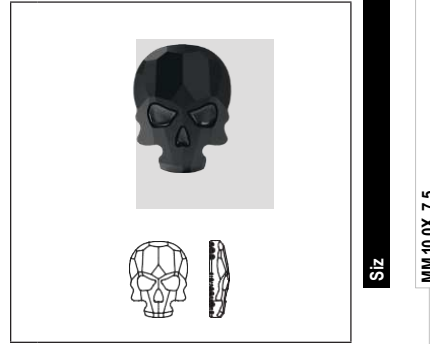

Siz

MM 10,0X 7,5

MM 14,0X 10,5

MM 18,0X 14,0

- Colors**
- Plain Colors**
- Jet M HF (280)
- Crystal Effects**
- Transparent Effects**
- Crystal AB M HF (001 AB)
- Crystal Golden Shadow M HF (001 GSHA)
- Crystal Silver Night M HF (001 SINI)
- Metallic Effects**
- Crystal Light Chrome M HF (001 LTCH)
- Crystal Metallic Blue M HF (001 METBL)
- Crystal Metallic Light Gold M HF (001 MLGLD)
- Color Effects**
- Jet Hematite M HF (280 HEM)

2858 BowTie FlatBack

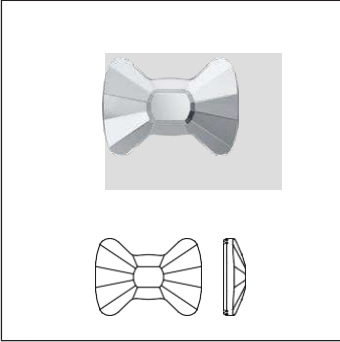

Siz

MM 6,0X 4,5

Crystal

Crystal M HF (001)

Crystal Effects

Transparent Effects

Crystal AB M HF (001 AB)

PRODUCT DETAILS

Article Size	Packing Unit = Minimum Order Quantity in Pieces	Average Net Weight in Gram per Packing Unit Crystal (001)	Average Gross Weight in Gram per Packing Unit Crystal (001)
2000 A HF			
SS 3	1,440	1.8	12.7
2035 M HF			
6 mm	360	27.1	34.8
10 mm	192	56.2	88.0
2038 A HF			
SS 5	1,440	4.2	12.1
SS 6	1,440	5.4	17.7
SS 8	1,440	9.96	18.2
SS 10	1,440	15.54	24.3
2038/I			
SS 10	1440	15.7	24.4
2078 A HF			
SS 12	1,440	21.6	30.4
SS 16	1,440	39.1	47.1
SS 20	1,440	72.0	79.6
SS 30	288	34.6	63.0
SS 34	144	26.0	48.6
SS 40	144	43.2	66.9
SS 48	96	61.4	87.4
2078/H A HF			
SS 16	1,440	77.6	86.5
SS 20	1,440	130.1	139.0
SS 34	144	38.5	47.4
2078/I A HF			
SS 16	1,440	39.1	47.1
SS 20	1,440	72.0	79.6
SS 34	144	25.9	48.6
2080/4 HF			
SS 10	1,440	17.1	28.3
SS 16	1,440	43.4	54.9
SS 34	144	23.2	34.1
2080/H M HF			
SS 34	144	40.5	49.5
2081/2 HF			
SS 10	1,440	30.52	40.52
SS 16	1,440	83.02	93.89
SS 34	144	46.76	56.79
2200 M HF			
4x2 mm	720	6.5	18.5
8x4 mm	360	24.8	35.8
2200/I M HF			
8x4 mm	360	25.14	36.02
2201 M HF			
8x3.5 mm	144	10.03	31.11
14x6 mm	72	21.67	45.27

Article Size	Packing Unit = Minimum Order Quantity in Pieces	Average Net Weight in Gram per Packing Unit Crystal (001)	Average Gross Weight in Gram per Packing Unit Crystal (001)
2208/4 HF			
6x3.5 mm	720	52.48	62.48
8x4.5 mm	480	124.71	134.71
10x5.5 mm	288	227.42	237.42
2300 M HF			
8x4.8 mm	360	41.9	51.0
2300/1 M HF			
8x4.8 mm	360	42.47	53.36
2303 M HF			
8x5 mm	144	15.70	39.60
14x9 mm	72	36.65	60.25
2304 M HF			
10x2.8 mm	180	10.2	20.4
2308/4 HF			
6x3.5 mm	720	64.58	74.58
8x5 mm	480	162.93	172.93
10x6 mm	288	233.15	243.15
2400 M HF			
2.2 mm	1,440	9.65	18.5
3 mm	1,440	25.3	36.8
4 mm	720	30.0	41.0
6 mm	144	21.9	32.7
10 mm	72	37.2	61.0
2402 M HF			
4 mm	720	22.3	33.1
6 mm	144	15.1	25.9
10 mm	72	30.5	54.1
2403 M HF			
4 mm	720	32.2	43.1
6 mm	144	21.9	32.8
10 mm	72	42.7	66.4
2408/4 HF			
4 mm	720	63.73	73.73
6 mm	480	185.67	195.67
8 mm	288	449.35	459.35
2493 M HF			
8 mm	216	72.3	91.8
10 mm	144	84.4	106.1
12 mm	96	96.4	127.8
2494 M HF			
6 mm	220	22.3	31.4
8 mm	144	29.5	50.2
10.5 mm	96	42.7	63.8
2510 M HF			
5x2.5 mm	720	23.2	32.3

Article Size	Packing Unit = Minimum Order Quantity in Pieces	Average Net Weight in Gram per Packing Unit Crystal (001)	Average Gross Weight in Gram per Packing Unit Crystal (001)
2555 M HF			
8x2.6 mm	240	18.4	27.5
12x4 mm	144	28.8	33.6
15x5 mm	72	28.9	46.0
2602 M HF			
8x5.5 mm	144	17.89	41.79
14x10 mm	72	58.61	82.21
2610 M HF			
6x4 mm	360	23.5	34.3
2709 M HF			
10x6 mm	288	28.9	67.2
2711 M HF			
3.3 mm	720	6.38	15.63
6 mm	360	29.7	40.7
2711/I M HF			
6 mm	360	30.10	40.97
2714 M HF			
6 mm	360	38.8	49.7
10 mm	144	59.8	84.3
2716 M HF			
5 mm	720	35.8	75.1
2728 M HF			
SS 10	1,440	14.1	24.6
SS 16	1,440	38.0	48.8
SS 20	1,440	65.7	76.5
SS 34	144	26.5	37.5
2738 M HF			
10x5 mm	144	16.7	35.1
12x6 mm	96	20.2	38.3
2739 M HF			
5.8x5.3 mm	216	19.2	41.9
7x6.5 mm	144	22.6	39.8
2740 M HF			
8.3x8.3 mm	216	35.1	54.2
10x10 mm	96	25.1	41.1
2753 M HF			
10 mm	72	15.8	39.4
14 mm	36	20.2	40.8
2770 M HF			
6x3.5 mm	1,440	60.3	70.3
2771			
6.4x4.2 mm	288	9.04	17.87
8.6x5.6 mm	216	16.84	43.02
12.9x8.3 mm	144	36.29	61.39

Article Size	Packing Unit = Minimum Order Quantity in Pieces	Average Net Weight in Gram per Packing Unit Crystal (001)	Average Gross Weight in Gram per Packing Unit Crystal (001)
2772			
6.5x2.1 mm	288	6.39	15.17
8.6x2.8 mm	288	16.29	40.71
12.9x4.2 mm	144	25.57	53.86
2773			
5x3 mm	288	4.83	13.66
6.6x3.9 mm	288	11.23	35.65
9.9x5.9 mm	144	19.30	43.39
2788 M HF			
8 mm	288	7.5	18.4
10 mm	216	10.5	37.7
2808 M HF			
6 mm	288	19.8	28.9
10 mm	144	38.8	55.9
2813 M HF			
8x5.5 mm	144	13.1	37.7
2816 M HF			
5 mm	720	23.6	30.7
2817 M HF			
5 mm	720	21.9	31.1
2826 M HF			
5 mm	720	23.06	30.1
2855 M HF			
8 mm	216	46.8	55.9
2858 M HF			
6x4.5 mm	240	12.5	21.7
2856			
10x7.5 mm	72	20.2	38.6
14x10.5 mm	36	30.2	50.3
18x14 mm	30	53.0	83.4



SEW-ON ARTICLES

Sew-on Articles are loose crystals that can be easily sewn either by hand, or with a standard domestic or industrial embroidery sewing machine onto any kind of textile or accessory. Sew-on Articles come in two- or three-hole varieties, with round and oval holes for use in a wide range of decorative applications, from fine embroidery to jewelry. Lochrosen are crystals with just one hole. Sew-on Articles have rounded edges around the holes to guarantee thread protection.

The assortment offers a great variety of colors and effects to transform textiles and fashion accessories into bespoke luxury items.

The most important items in this product group are art. 3188 XIRIUS Lochrose and art. 3288 XIRIUS Sew-on Stone, which feature the most progressive and unique cut on the market: multilayer cut technology, creating the inspiring XIRIUS star design.

NUMERICAL ORDER

001	Crystal
001 AB	Crystal Aurare Boreale
001 API	Crystal Astral Pink
001 ANTP	Crystal Antique Pink*
001 BLAPA	Crystal Black Patina 001
BLSH	Crystal Blue Shade
001 COP	Crystal Copper*
001 GOLPA	Crystal Gold Patina
001 GSHA	Crystal Golden Shadow 001
IRIG	Crystal Iridescent Green
001 LISH	Crystal Liac Shadow
001 LTCH	Crystal Light Chrome 001
LUMG	Crystal Luminous Green 001
METSH	Crystal Metallic Sunshine
001 MOL	Crystal Moonlight
001 PARSH	Crystal Paradise Shine*
001 RABDK	Crystal Rainbow Dark
001 ROGL	Crystal Rose Gold
001 ROSPA	Crystal Rose Patina
001 SAT	Crystal Satin
001 SCGR	Crystal Scarabaeus Green***
001 SHIM	Crystal Shimmer
001 SILPA	Crystal Silver Patina
001 SINI	Crystal Silver Night
001 SSHA	Crystal Silver Shade
001 VM	Crystal Vitrail Medium
001 WHIPA	Crystal White Patina
202	Aquamarine
204 SHIM	Amethyst Shimmer
205	Emerald
206	Sapphire
211	Light Sapphire
211 SHIM	Light Sapphire Shimmer
212	Light Amethyst
214	Peridot
215	Black Diamond
215 SHIM	Black Diamond Shimmer
223	Light Rose
226	Light Topaz
226 SHIM	Light Topaz Shimmer
227	Light Siam
227 SHIM	Light Siam Shimmer
231	Yellow Opal
234	White Opal
246	Light Colorado Topaz
246 SHIM	Light Colorado Topaz Shimmer
253	Graphite
257	Blush Rose
261	Light Silk
263	Light Turquoise
265	Smoky Mauve
266	Denim Blue
276	Scarlet
280	Jet
280 HEM	Jet Hematite
291	Fern Green
292	Sunflower
296	Majestic Blue ¹
319	Vintage Rose
360	Eternite
360 SHIM	Eternite Shimmer
362	Light Peach
502	Fuchsia
508	Rosaline

ALPHABETICAL ORDER



Amethyst Shimmer (204 SHIM)
Aquamarine (202)
Black Diamond (215)
Black Diamond Shimmer (215 SHIM)
Blush Rose (257)
Crystal (001)
Crystal Antique Pink (001 ANTP)*
Crystal Astral Pink (001 API) Crystal Aurare Boreale (001 AB) Crystal Black Patina (001 BLAPA) Crystal Blue Shade (001 BLSH) Crystal Copper (001 COP)* Crystal Gold Patina (001 GOLPA) Crystal Golden Shadow (001 GSHA) Crystal Iridescent Green (001 IRIG) Crystal Light Chrome (001 LTCH) Crystal Liac Shadow (001 LISH) Crystal Luminous Green (001 LUMG) Crystal Metallic Sunshine (001 METSH) Crystal Moonlight (001 MOL) Crystal Paradise Shine (001 PARSH)* Crystal Rainbow Dark (001 RABDK) Crystal Rose Gold (001 ROGL) Crystal Rose Patina (001 ROSPA) Crystal Satin (001 SAT) Crystal Scarabaeus Green*** (001 SCGR) Crystal Shimmer (001 SHIM) Crystal Silver Night (001 SINI) Crystal Silver Patina (001 SILPA) Crystal Silver Shade (001 SSHA) Crystal Vitrail Medium (001 VM) Crystal White Patina (001 WHIPA)
Denim Blue (266)
Emerald (205)
Eternite (360)
Eternite Shimmer (360 SHIM)
Fern Green (291)
Fuchsia (502)
Graphite (253)
Jet (280)
Jet Hematite (280 HEM)
Light Amethyst (212)
Light Colorado Topaz (246)
Light Colorado Topaz Shimmer (246 SHIM)
Light Peach (362)
Light Rose (223)
Light Sapphire (211)
Light Sapphire Shimmer (211 SHIM)
Light Siam (227)
Light Siam Shimmer (227 SHIM)
Light Silk (261)
Light Topaz (226)
Light Topaz Shimmer (226 SHIM)
Light Turquoise (263)
Majestic Blue (296) ¹
Peridot (214)
Rosaline (508)
Sapphire (206)
Scarlet (276)
Smoky Mauve (265)
Sunflower (292)
Vintage Rose (319)
White Opal (234)
Yellow Opal (231)

Communication on Product-Assortment changes*

IMPORTANT INFORMATION ON ASSORTMENT ADJUSTMENTS



























We would kindly like to inform you about overall portfolio streamlining as well as discontinuations of selected product lines, effective as of November 23rd, 2020.

In order to allow you sufficient time to prepare, upcoming changes are already visible in our B2B e-commerce platform. During this transition phase the collection has been marked with the following caption:

Caption - SUMMARY	
	OUT OF ASSORTMENT
	CHANGES IN THE ASSORTMENT
	NO CHANGES IN THE ASSORTMENT

Caption - MATRIX	
	OUT OF ASSORTMENT
	FUTURE MADE TO ORDER ITEM - MTO
	FUTURE MADE TO STOCK ITEM - MTS

SUMMARY

1 2 	3129 7 mm	1 2 	3250 18x13 mm	1 2 	COREASSORTMENT 3288 8, 10, 12 mm
	COREASSORTMENT 3188 3, 4, 5, 6, 7, 8 mm		3252 14x10, 20x14, 28x20 mm		3293 12 mm
	COREASSORTMENT 3200 10, 12, 14, 16, 18 mm		DESIGNER EDITION 3254 20x9, 30x14 mm		3400 6, 8 mm
	3201 10, 12, 14 mm		3255 18x6, 26x8.5 mm		3700 6, 8, 10, 12, 14 mm
	3210 10x7, 16x11, 24x17 mm		3256 14x8.5, 19x11.5 mm		3211 3, 4, 5, 6, 7, 8 mm
	3211 14x9, 18x12 mm		3258 12x8.5, 16x11.5 mm		3271 18x21.1, 25x28.7 mm
	3220 10, 14 mm		3259 12 mm		3296 7x7, 10x10 mm
	3221 18 mm		3261 18, 28 mm		3297 7x7, 10x10 mm
	3223 12x6, 18x9, 29x14.5 mm		3265 20x16, 26x21 mm		
	COREASSORTMENT 3230 12x7, 18x10.5, 28x17 mm		3267 18x10 mm		
	3231 18x11, 23x14 mm		3270 16, 22 mm		
	3240 16, 22 mm		3272 16, 20, 28 mm		

3129

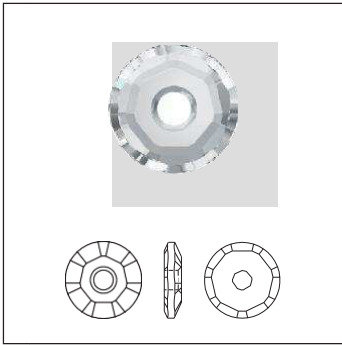

Siz
MM 7,0

- Crystal**
- Crystal P288 (001)
- Colors**
- Plain Colors**
- Black Diamond P288 (215)
- Jet P288 (280)
- Crystal Effects**
- Transparent Effects**
- Crystal AB P288 (001 AB)
- Color Effects**
- Metallic Effects**
- Jet Hematite P288 (280 HEM)

CORE ASSORTMENT

3188 XIRIUS Lochrose

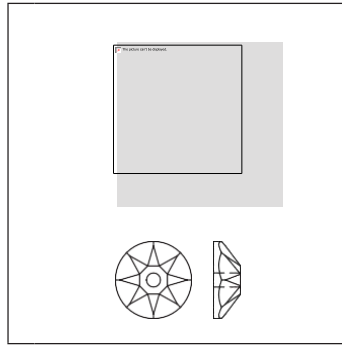

Siz
MM 3,0
MM 4,0
MM 5,0
MM 6,0
MM 7,0
MM 8,0

- Crystal**
- Crystal (001)
- Crystal F (001)
- Colors**
- Plain Colors**
- Amethyst F (204)
- Aquamarine F (202)
- Black Diamond F (215)
- Blush Rose F (257)
- Denim Blue F (266)
- Emerald F (205)
- Fuchsia F (502)
- Graphite F (253)
- Iris F (219)
- Jet (280)
- Light Colorado Topaz F (246)
- Light Peach F (362)
- Light Rose F (223)
- Light Siam F (227)
- Light Silk F (261)
- Scarlet F (276)
- Smoky Mauve F (265)
- Crystal Effects**
- Transparent Effects**
- Crystal Astral Pink F (001 API)
- Crystal AB F (001 AB)
- Crystal Blue Shade F (001 BLSH)
- Crystal Golden Shadow F (001 GSHA)
- Crystal Lilac Shadow F (001 LISH)
- Crystal Luminous Green F (001 LUMG)
- Crystal Moonlight F (001 MOL)
- Crystal Paradise Shine F (001 PARSH)
- Crystal Silver Night (001 SINI)
- Crystal Silver Shade F (001 SSHA)
- Metallic Effects**

*** designed by Jean Paul Gaultier

◆ Core Assortment

CORE ASSORTMENT

3200 Rivoli Sew-on Stone

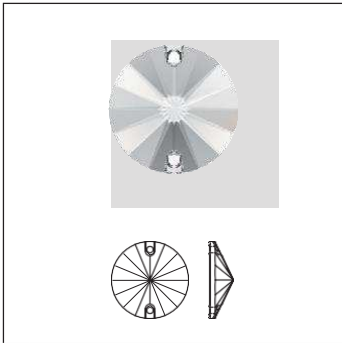

Siz	MM 10,0	MM 12,0	MM 14,0	MM 16,0	MM 18,0
-----	---------	---------	---------	---------	---------

Crystal					
Crystal F (001)	■	■	■	■	■
Colors					
Plain Colors					
Amethyst F (204)	■	■	■		
Aquamarine F (202)	■	■	■		
Black Diamond F (215)	■	■	■		
Blush Rose F (257)	■	■	■		
Emerald F (205)	■	■	■		
Fuchsia F (502)	■				
Graphite F (253)	■	■	■		
Iris F (219)	■	■	■		
Jet (280)	■	■	■		
Light Colorado Topaz F (246)	■	■	■		
Light Rose F (223)	■	■	■		
Light Siam F (227)	■	■	■		
Light Turquoise F (263)	■				
Scarlet F (276)	■	■	■		
Opal Colors					
Yellow Opal F (231)	■				
Crystal Effects					
Transparent Effects					
Crystal AB F (001 AB)	■	■	■	■	■
Crystal Golden Shadow F (001 GSHA)	■	■			
Crystal Paradise Shine F (001 PARSH)	■	■	■		
Crystal Satin F (001 SATIN)	■	■			
Metallic Effects					
Crystal Iridescent Green F (001 IRIG)	■	■	■		
Crystal Metallic Sunshine F (001 METSH)	■	■	■		
Color Effects					
Amethyst Shimmer F (204 SHIM)			■		
Jet Hematite (280 HEM)	■	■	■		

3201 Rivoli Square Sew-on Stone

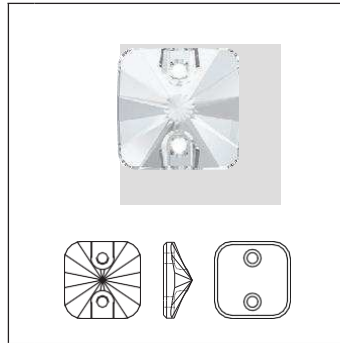

Siz	MM 10,0	MM 12,0	MM 14,0
-----	---------	---------	---------

Crystal			
Crystal F (001)	■	■	■
Colors			
Plain Colors			
Blush Rose F (257)		■	■
Denim Blue F (266)		■	■
Jet (280)		■	■
Light Colorado Topaz F (246)		■	■
Light Siam F (227)		■	
Crystal Effects			
Transparent Effects			
Crystal AB F (001 AB)		■	■
Crystal Golden Shadow F (001 GSHA)		■	■
Crystal Luminous Green F (001 LUMG)		■	■
Crystal Silver Night (001 SINI)		■	■
Metallic Effects			
Crystal Iridescent Green F (001 IRIG)		■	■
Crystal Metallic Sunshine F (001 METSH)		■	■
Crystal Rose Gold F (001 ROGL)		■	■

3188 XRUSLOCH-ROSE



Siz	MM 3,0	MM 4,0	MM 5,0	MM 6,0	MM 7,0	MM 8,0
-----	--------	--------	--------	--------	--------	--------

Crystal Iridescent Green F (001 IRIG)	■	■	■			
Crystal Light Chrome F (001 LTCH)	■	■	■	■		
Crystal Metallic Sunshine F (001 METSH)	■	■	■	■		
Crystal Scarabaeus Green F (001 SCGR)	■	■	■			
Color Effects						
Jet Hematite (280 HEM)	■	■	■			

3210 Oval Sew-on Stone

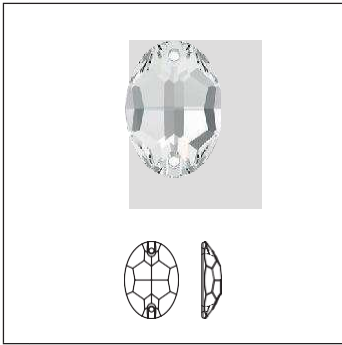

Siz	MM 10,0X 7,0	MM 16,0X 11,0	MM 24,0X 17,0
-----	--------------	---------------	---------------

Crystal			
Crystal F (001)	■	■	■
Colors			
Plain Colors			
Amethyst F (204)	■		
Light Colorado Topaz F (246)	■		
Crystal Effects			
Transparent Effects			
Crystal AB F (001 AB)	■	■	■
Crystal Silver Night (001 SINI)	■	■	■
Metallic Effects			
Crystal Light Chrome F (001 LTCH)	■	■	■
Crystal Metallic Sunshine F (001 METSH)	■	■	■
Crystal Patina			
Crystal Black Patina F (001 BLAPA)	■	■	■
Crystal Gold Patina F (001 GOLPA)	■	■	■
Crystal Rose Patina F (001 ROSPA)	■	■	■
Crystal Silver Patina F (001 SILPA)	■	■	■
Crystal White Patina F (001 WHIPA)	■	■	■

3211 Lemon Sew-on Stone

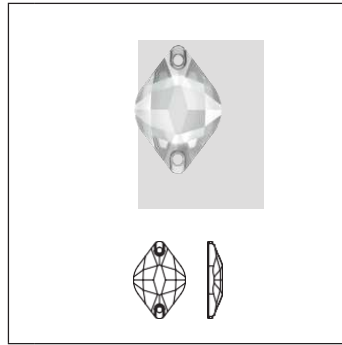

Siz	MM 14,0X 9,0	MM 18,0X 12,0
-----	--------------	---------------

Crystal		
Crystal F (001)	■	■
Colors		
Plain Colors		
Denim Blue F (266)	■	
Graphite F (253)	■	
Light Colorado Topaz F (246)	■	
Light Siam F (227)	■	■
Opal Colors		
White Opal F (234)	■	
Crystal Effects		
Transparent Effects		
Crystal Antique Pink F (001 ANTP)	■	
Crystal AB F (001 AB)	■	■
Crystal Golden Shadow F (001 GSHA)	■	■
Crystal Satin F (001 SATIN)	■	■
Crystal Silver Night (001 SINI)	■	

3220 Round Chessboard Sew-on Stone

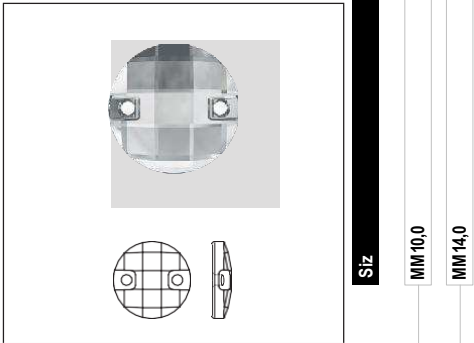

Siz
MM 10,0
MM 14,0

- Crystal**
- Crystal F (001)
- Crystal Effects**
- Transparent Effects
- Crystal AB F (001 AB)
- Crystal Golden Shadow F (001 GSHA)

3221 Twist Sew-on Stone

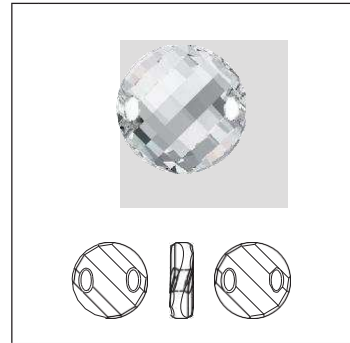

Siz
MM 18,0

- Crystal**
- Crystal F (001)
- Crystal Effects**
- Transparent Effects
- Crystal Golden Shadow (001 GSHA)

3223 Navette Sew-on Stone

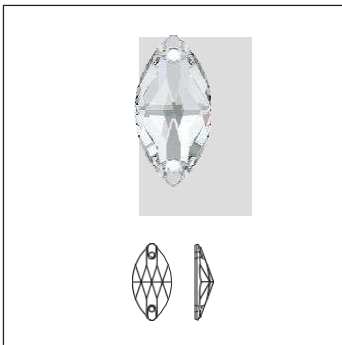

Siz
MM 12,0X 6,0
MM 18,0X 9,0
MM 29,0X 14,5

- Crystal**
- Crystal F (001)
- Colors**
- Plain Colors
- Amethyst F (204)
- Jet (280)
- Crystal Effects**
- Transparent Effects
- Crystal AB F (001 AB)
- Crystal Golden Shadow F (001 GSHA)

CORE ASSORTMENT

3230 Drop Sew-on Stone

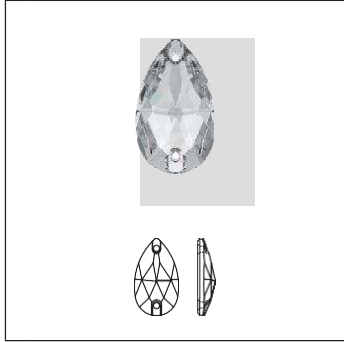

Siz	MM 12,0X 7,0	MM 18,0X 10,5	MM 28,0X 17,0
-----	--------------	---------------	---------------

Crystal

Crystal F (001)	■	■	■
-----------------	---	---	---

Colors

Plain Colors

Amethyst F (204)	■	■	■
Aquamarine F (202)	■	■	■
Black Diamond F (215)	■	■	■
Emerald F (205)	■	■	■
Erinite F (360)	■	■	■
Fuchsia F (502)	■	■	■
Graphite F (253)	■	■	■
Jet (280)	■	■	■
Light Amethyst F (212)	■	■	■
Light Colorado Topaz F (246)	■	■	■
Light Rose F (223)	■	■	■
Light Sapphire F (211)	■	■	■
Light Siam F (227)	■	■	■
Light Topaz F (226)	■	■	■
Light Turquoise F (263)	■	■	■
Rosaline F (508)	■	■	■
Rose Peach F (262)	■	■	■
Scarlet F (276)	■	■	■

Crystal Effects

Transparent Effects

Crystal Astral Pink F (001 API)	■	■	■
Crystal AB F (001 AB)	■	■	■
Crystal Blue Shade F (001 BLSH)	■	■	■
Crystal Copper F (001 COP)	■	■	■
Crystal Golden Shadow (001 GSHA)	■	■	■
Crystal Golden Shadow F (001 GSHA)	■	■	■
Crystal Luminous Green F (001 LUMG)	■	■	■
Crystal Satin F (001 SATIN)	■	■	■
Crystal Shimmer F (001 SHIM)	■	■	■
Crystal Silver Night (001 SINI)	■	■	■

Metallic Effects

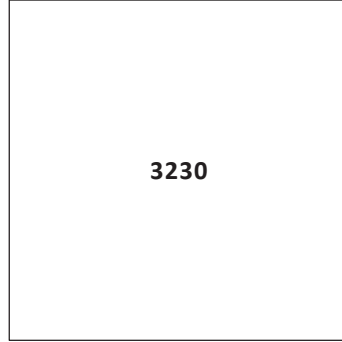

Siz	MM 12,0X 7,0	MM 18,0X 10,5	MM 28,0X 17,0
-----	--------------	---------------	---------------

Crystal Light Chrome F (001 LTCH)	■	■	■
Crystal Rainbow Dark F (001 RABDK)	■	■	■
Color Effects			
Amethyst Shimmer F (204 SHIM)	■	■	■
Black Diamond Shimmer F (215 SHIM)	■	■	■
Erinite Shimmer F (360 SHIM)	■	■	■
Light Amethyst Shimmer F (212 SHIM)	■	■	■
Light Colorado Topaz Shimmer F (246 SHIM)	■	■	■
Light Rose Shimmer F (223 SHIM)	■	■	■
Light Sapphire Shimmer F (211 SHIM)	■	■	■
Light Siam Shimmer F (227 SHIM)	■	■	■
Light Topaz Shimmer F (226 SHIM)	■	■	■
Rose Peach Shimmer F (262 SHIM)	■	■	■

3231 Oval Sew-on Stone

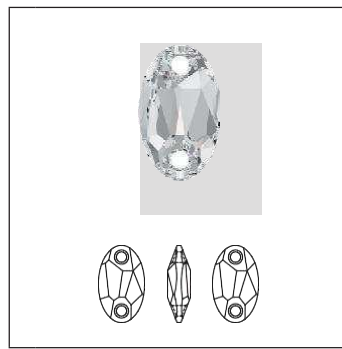

Siz	MM 18,0X 11,0	MM 23,0X 14,0
-----	---------------	---------------

Crystal

Crystal (001)	■	■
Crystal F (001)	■	■

Crystal Effects

Transparent Effects

Crystal Golden Shadow (001 GSHA)	■	■
----------------------------------	---	---

3240 Square Sew-on Stone

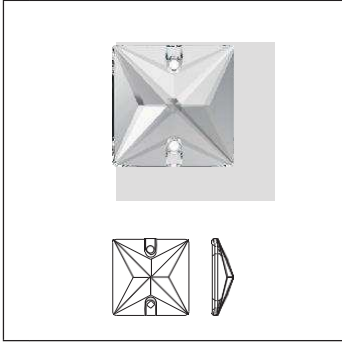

Size
MM 16,0
MM 22,0

- Crystal**
- Crystal F (001)
- Colors**
- Plain Colors
- Jet (280)
- Crystal Effects**
- Transparent Effects
- Crystal AB F (001 AB)
- Color Effects**
- Metallic Effects
- Jet Hematite (280 HEM)

3250 Rectangle Sew-on Stone

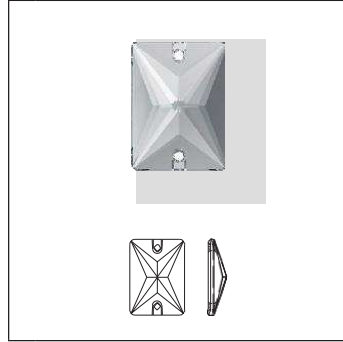

Size
MM 18,0X 13,0

- Crystal**
- Crystal F (001)
- Crystal Effects**
- Transparent Effects
- Crystal AB F (001 AB)

3252 Emerald Cut Sew-on Stone



Size
MM 14,0X 10,0
MM 20,0X 14,0
MM 26,0X 20,0

- Crystal**
- Crystal F (001)
- Colors**
- Plain Colors
- Aquamarine F (202)
- Emerald F (205)
- Graphite F (253)
- Jet (280)
- Majestic Blue F (296)
- Scarlet F (276)
- Sunflower F (292)
- Vintage Rose F (319)
- Crystal Effects**
- Transparent Effects
- Crystal AB F (001 AB)
- Crystal Golden Shadow F (001 GSHA)
- Crystal Silver Shade F (001 SSHA)

DIAMOND LEAF¹

DESIGNER EDITION

Swarovski and Giorgio Armani worked together to create an exclusive crystal called Diamond Leaf. This Designer Edition has a fluid, organic shape reminiscent of a leaf. Precision-cut facets melt into the softness of a floating, sculptural form, contrasting strength and fragility, the timeless with the ethereal.

Giorgio Armani: "Swarovski crystal brings a touch of magic to a dress, an ethereal quality, a luster that never fails to captivate the attention."

3254 Diamond Leaf Sew-on Stone¹

	Siz MM 20,0X 9,0 MM 30,0X 14,0		
Crystal			
Crystal F (001)		■	■
Colors			
Plain Colors			
Jet (280)		■	■
Crystal Effects			
Transparent Effects			
Crystal Golden Shadow F (001 GSHA)		■	■
Crystal Silver Shade F (001 SSHA)		■	

THE DIAMOND LEAF DESIGNER EDITION FAMILY



2797
8x4 mm

chapter07 Flat Back No Hoop
p. 397



3254
20x9, 30x14 mm

chapter09 Sew-on Articles
p. 455

DESIGNER EDITIONS – DISTINCT PACKAGING

This Designer Edition will be labeled with the "Designer Edition" imprint directly on the packaging.

¹ Article consists of Advanced Crystal

3255 Cosmic Baguette Sew-on Stone

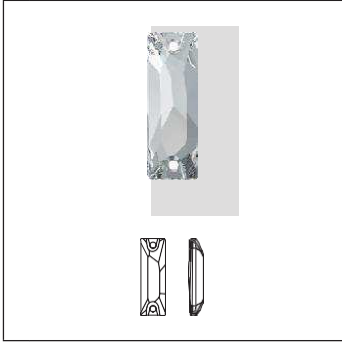

Siz

MM 18,0X 6,0

MM 26,0X 8,5

Crystal

Crystal F (001)

Colors

Plain Colors

Jet (280)

Crystal Effects

Transparent Effects

Crystal Golden Shadow F (001 GSHA)

Crystal Silver Shade F (001 SSHA)

3256 Galactic Sew-on Stone

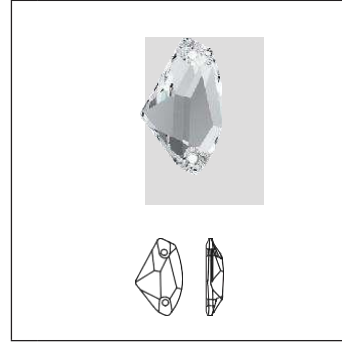

Siz

MM 14,0X 8,5

MM 19,0X 11,5

Crystal

Crystal F (001)

Colors

Plain Colors

Jet (280)

Crystal Effects

Transparent Effects

Crystal Golden Shadow F (001 GSHA)

3258 Bow Tie Sew-on Stone

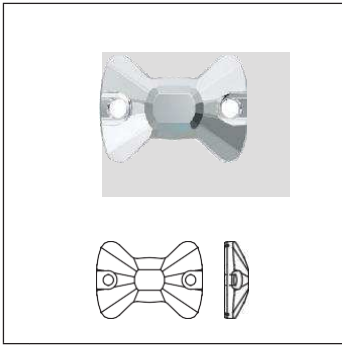

Siz
MM 12,0X 8,5
MM 16,0X 11,5

- Crystal**
- Crystal F (001)
- Colors**
- Plain Colors**
- Denim Blue F (266)
- Jet (280)
- Light Amethyst F (212)
- Light Siam F (227)
- Vintage Rose F (319)
- Crystal Effects**
- Transparent Effects**
- Crystal AB F (001 AB)
- Crystal Golden Shadow F (001 GSHA)
- Crystal Paradise Shine F (001 PARSH)
- Crystal Silver Night (001 SINI)
- Metallic Effects**
- Crystal Iridescent Green F (001 IRIG)

3259 Heart Sew-on Stone

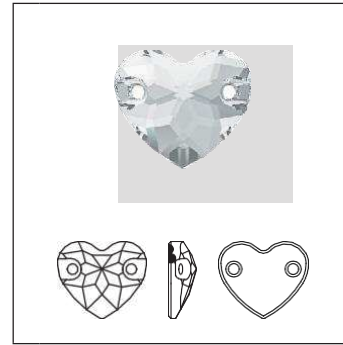

Siz
MM 12,0

- Crystal**
- Crystal F (001)
- Colors**
- Plain Colors**
- Denim Blue F (266)
- Jet (280)
- Light Siam F (227)
- Light Silk F (261)
- Smoky Mauve F (265)
- Vintage Rose F (319)
- Opal Colors**
- White Opal F (234)
- Crystal Effects**
- Transparent Effects**
- Crystal AB F (001 AB)
- Crystal Golden Shadow F (001 GSHA)
- Crystal Lilac Shadow F (001 LISH)
- Crystal Paradise Shine F (001 PARSH)
- Crystal Silver Night (001 SINI)
- Metallic Effects**
- Crystal Rose Gold F (001 ROGL)

3261 Hexagon Sew-on Stone



Siz

MM18,0
MM28,0

Crystal

Crystal F (001)

3265 Cosmic Sew-on Stone



Siz

MM 20,0X 16,0
MM 26,0X 21,0

Crystal

Crystal F (001)

Colors

Plain Colors

Jet (280)

Crystal Effects

Transparent Effects

Crystal AB F (001 AB)

Crystal Golden Shadow F (001 GSHA)

3267 De-Art Sew-on Stone



Siz

MM 18,0X 10,0

Crystal

Crystal F (001)

3270 Triangle Sew-on Stone



Siz

MM 16,0
MM 22,0

Crystal

Crystal F (001)

Colors

Plain Colors

Jet (280)

Crystal Effects

Transparent Effects

Crystal AB F (001 AB)

TRILLIANT SEW-ON STONE

3272 Trilliant Sew-on Stone

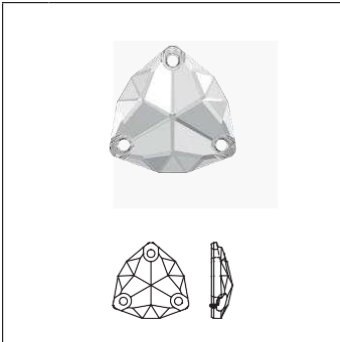

Size 16, 20 mm

3272 Trilliant Sew-on Stone

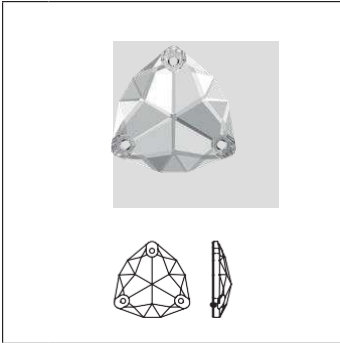

Size 28 mm

3271 SLIM TRIANGLE SEW-ON



Siz
MM 18,0X 21,1
MM 25,0X 28,7

Crystal

Crystal F (001)

Colors

Plain Colors

Jet (280)

Crystal Effects

Transparent Effects

Crystal AB F (001 AB)

Crystal Golden Shadow F (001 GSHA)

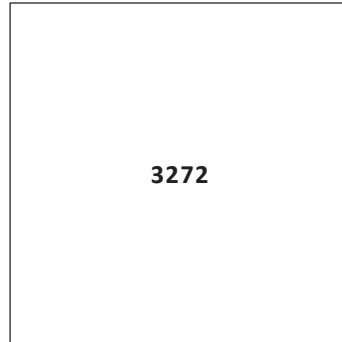

3272

Siz
MM 16,0
MM 20,0
MM 28,0

Crystal

Crystal F (001)

Colors

Plain Colors

Aquamarine F (202)

Emerald F (205)

Graphite F (253)

Jet (280)

Sapphire F (206)

Scarlet F (276)

Sunflower F (292)

Vintage Rose F (319)

Crystal Effects

Transparent Effects

Crystal AB F (001 AB)

Crystal Golden Shadow F (001 GSHA)

Crystal Silver Shade F (001 SSHA)

CORE ASSORTMENT

3288 XIRIUS Sew-on Stone

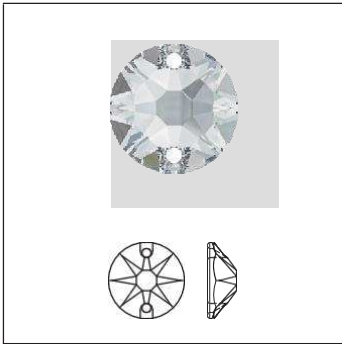

Siz	MM 8,0	MM 10,0	MM 12,0
-----	--------	---------	---------

Crystal

Crystal F (001)

Colors

Plain Colors

- Amethyst F (204)
- Aquamarine F (202)
- Black Diamond F (215)
- Blush Rose F (257)
- Denim Blue F (266)
- Emerald F (205)
- Graphite F (253)
- Jet (280)
- Light Colorado Topaz F (246)
- Light Peach F (362)
- Light Rose F (223)
- Light Siam F (227)
- Scarlet F (276)
- Smoky Mauve F (265)

Opal Colors

Yellow Opal F (231)

Crystal Effects

Transparent Effects

- Crystal Astral Pink F (001 API)
- Crystal AB F (001 AB)
- Crystal Blue Shade F (001 BLSH)
- Crystal Golden Shadow F (001 GSHA)
- Crystal Luminous Green F (001 LUMG)
- Crystal Moonlight F (001 MOL)
- Crystal Paradise Shine F (001 PARSH)
- Crystal Silver Night (001 SINI)
- Crystal Silver Shade F (001 SSHA)

Metallic Effects

- Crystal Iridescent Green F (001 IRIG)
- Crystal Light Chrome F (001 LTCH)
- Crystal Metallic Sunshine F (001 METSH)
- Crystal Scarabaeus Green F (001 SCGR)

Color Effects

Jet Hematite (280 HEM)

3293 Chessboard Sew-on Stone

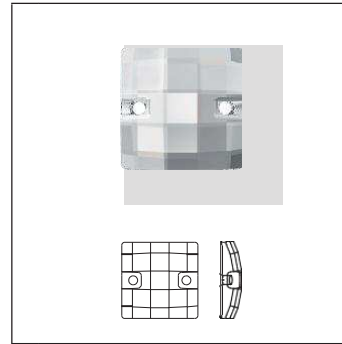

Siz	MM 12,0
-----	---------

Crystal

Crystal F (001)

*** designed by Jean Paul Gaultier
 ◆ Core Assortment

3296 SQUARE SPIKESEW-ON STONE

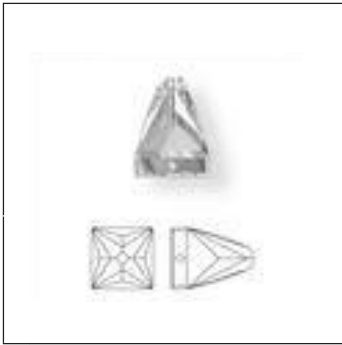

Siz
MM 7,0X 7,0
MM 10,0X 10,0

- Crystal**
- Crystal F (001)
- Crystal Effects**
- Transparent Effects**
- Crystal AB F (001 AB)
- Crystal Blue Shade F (001 BLSH)
- Crystal Golden Shadow F (001 GSHA)
- Crystal Volcano F (001 VOL)
- Color Effects**
- Black Diamond Shimmer F (215 SHIM)
- Light Topaz Shimmer F (226 SHIM)

3297 ROUND SPIKESEW-ON STONE



Siz
MM 7,0X 7,0
MM 10,0X 10,0

- Crystal**
- Crystal F (001)
- Crystal Effects**
- Transparent Effects**
- Crystal AB F (001 AB)
- Crystal Blue Shade F (001 BLSH)
- Crystal Golden Shadow F (001 GSHA)
- Crystal Volcano F (001 VOL)
- Color Effects**
- Black Diamond Shimmer F (215 SHIM)
- Light Topaz Shimmer F (226 SHIM)

3400 Square Lochrose

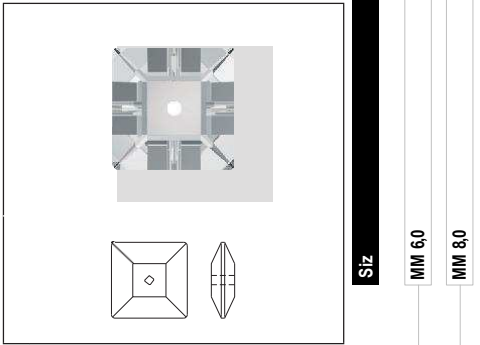

Siz

MM 6,0
MM 8,0

Crystal

Crystal F (001)

Colors

Plain Colors

Light Colorado Topaz F (246)

Crystal Effects

Transparent Effects

Crystal AB F (001 AB)

Crystal Satin F (001 SATIN)

3700 Marguerite Lochrose

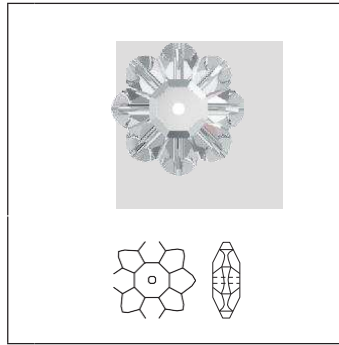

Siz

MM 6,0
MM 8,0
MM 10,0
MM 12,0
MM 14,0

Crystal

Crystal (001)

Crystal F (001)

Colors

Plain Colors

Amethyst (204)

Amethyst F (204)

Emerald (205)

Fern Green (291)

Peridot (214)

Crystal Effects

Transparent Effects

Crystal AB (001 AB)

Crystal Vitrail Medium (001 VM)

PRODUCT DETAILS

Article Size	Packing Unit = Minimum Order Quantity in Pieces	Average Net Weight in Gram per Packing Unit Crystal (001)	Average Gross Weight in Gram per Packing Unit Crystal (001)
3129			
7 mm	2,880	291.3	473.2
3188			
3 mm	1,440	21.5	30.0
4 mm	1,440	47.6	56.0
5 mm	720	43.2	51.7
6 mm	360	35.7	44.1
7 mm	144	22.2	30.7
8 mm	144	33.2	41.7
3200			
10 mm	72	26.1	44.6
12 mm	72	54.9	74.0
14 mm	72	77.2	100.7
16 mm	72	115.8	139.4
18 mm	48	117.2	199.5
3201			
10 mm	144	70.3	89.2
12 mm	72	61.3	86.5
14 mm	72	85.5	115.0
3210			
10x7 mm	72	18.1	37.9
16x11 mm	72	66.3	86.3
24x17 mm	24	72.5	97.9
3211			
14x9 mm	72	31.7	55.3
18x12 mm	48	52.3	76.1
3220			
10 mm	192	69.4	97.3
14 mm	96	88.7	120.2
3221			
18 mm	72	174.8	198.5
3223			
12x6 mm	48	13.1	34.2
18x9 mm	36	27.7	45.1
29x14.5 mm	24	74.28	101.3
3230			
12x7 mm	96	29.7	47.0
18x10.5 mm	72	70.5	90.7
28x17 mm	24	72.1	97.5
3231			
18x11 mm	96	120.5	148.2
23x14 mm	36	96.4	126.9
3240			
16 mm	72	108.5	132.1
22 mm	24	88.0	139.6
3250			
18x13 mm	72	111.5	135.1

Article Size	Packing Unit = Minimum Order Quantity in Pieces	Average Net Weight in Gram per Packing Unit Crystal (001)	Average Gross Weight in Gram per Packing Unit Crystal (001)
3252			
14x10 mm	36	29.59	50.19
20x14 mm	15	35.55	60.28
28x20 mm	10	67.65	88.78
3254			
20x9 mm	72	60.3	87.8
30x14 mm	36	100.6	129.6
3255			
18x6 mm	96	64.3	87.1
26x8.5 mm	48	87.6	125.6
3256			
14x8.5 mm	96	48.2	67.5
19x11.5 mm	96	104.5	140.1
3258			
12x8.5 mm	96	37.1	58.2
16x11.5 mm	48	36.3	57.5
3259			
12 mm	72	53.9	77.7
3261			
18 mm	72	78.3	110.3
28 mm	30	150.7	175.6
3265			
20x16 mm	72	113.5	138.4
26x21 mm	20	59.8	85.0
3267			
18x10 mm	96	96.0	133.0
3270			
16 mm	72	96.4	120.0
22 mm	24	72.3	117.4
3272			
16 mm	24	34.39	54.99
20 mm	15	37.4	62.13
28 mm	8	55.14	76.89
3288			
8 mm	144	51.0	61.9
10 mm	72	53.9	80.3
12 mm	72	69.8	96.5
3293			
12 mm	72	72.3	95.7
3400			
6 mm	360	47.5	58.4
8 mm	288	81.1	107.2
3700			
6 mm	720	50.6	61.4
8 mm	288	62.2	88.4
10 mm	288	114.5	141.0
12 mm	144	105.4	128.5
14 mm	144	170.5	197.2